



CITY

60373





[LEGO.com/sustainable-packaging](https://LEGO.com/sustainable-packaging)

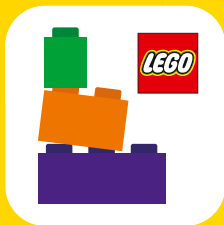

# BUILDER



Apple and the Apple logo are trademarks of Apple Inc., registered in the U.S. and other countries and regions. App Store is a service mark of Apple Inc. Google Play and the Google Play logo are trademarks of Google LLC. Tencent and the Tencent logo are trademarks of Tencent Inc.

 [LEGO.com/devicecheck](https://LEGO.com/devicecheck)

**EN** Ask parents' permission before going online | **DE** Eltern um Erlaubnis bitten, bevor du online gehst | **FR** Demande l'autorisation d'un parent avant d'aller en ligne | **IT** Chiedi il permesso ai tuoi genitori prima di andare online | **ES** Pídeles permiso a tus papás antes de conectarte a Internet | **PT** Pede autorização aos pais antes de acederes online | **JA** オンラインになる前に ほご者の方のきよかをもらおう | **ZH** 上网前应先征得父母的同意 | **KO** 온라인 접속 전에 보호자 동의가 필요합니다 | **RU** Спроси разрешения у родителей, прежде чем заходить в интернет | **PL** Poproś rodziców o zgodę, zanim wejdiesz do Internetu | **CS** Než půjdeš na internet, požádej rodiče o svolení | **SK** Skôr než pôjdeš na internet, vypýtaj si povolenie od rodičov | **HU** Kérj szülői engedélyt, mielőtt online csatlakoznál! | **RO** Cere permisiunea părinților înainte de a te conecta online | **BG** Поискайте разрешение от родители, преди да влезете онлайн | **LV** Pirms došanās tiešsaistē palūdz atļauju vecākiem | **ET** Enne Interneti kasutamist küsi vanematelt luba | **LT** Prieš prisijungdami prie interneto, atsiklauskite tėvų



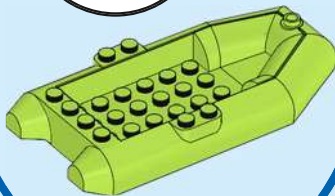
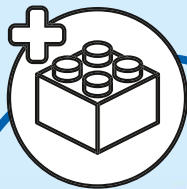

1

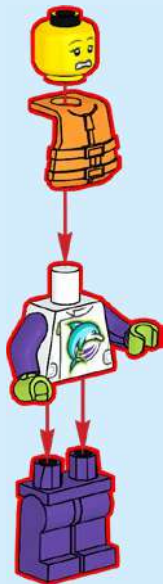

2



1

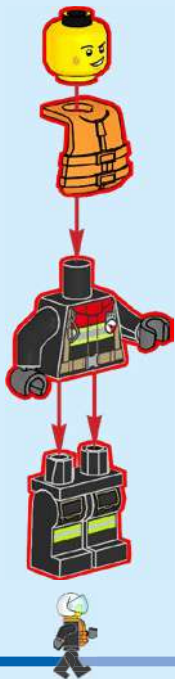

2

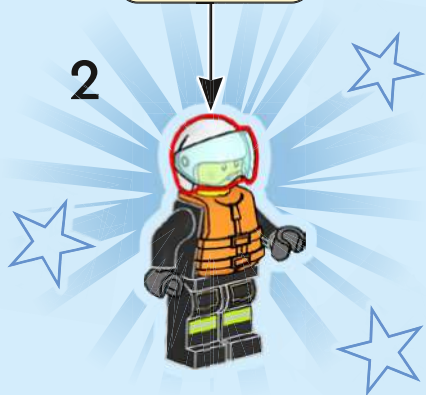
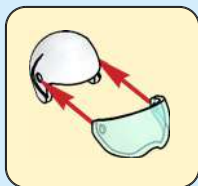



1



2

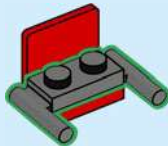



3

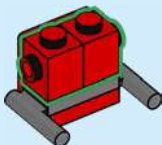

8





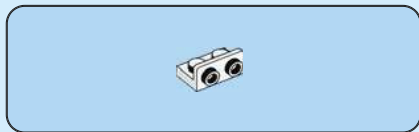

4

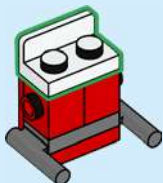

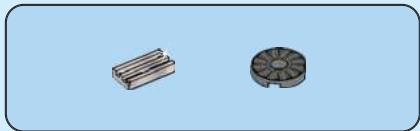

5



10





6





7



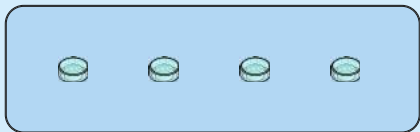

8

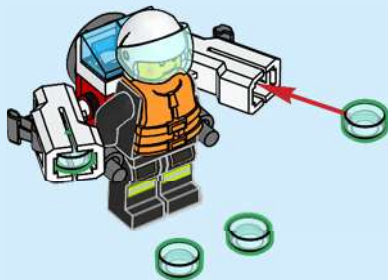

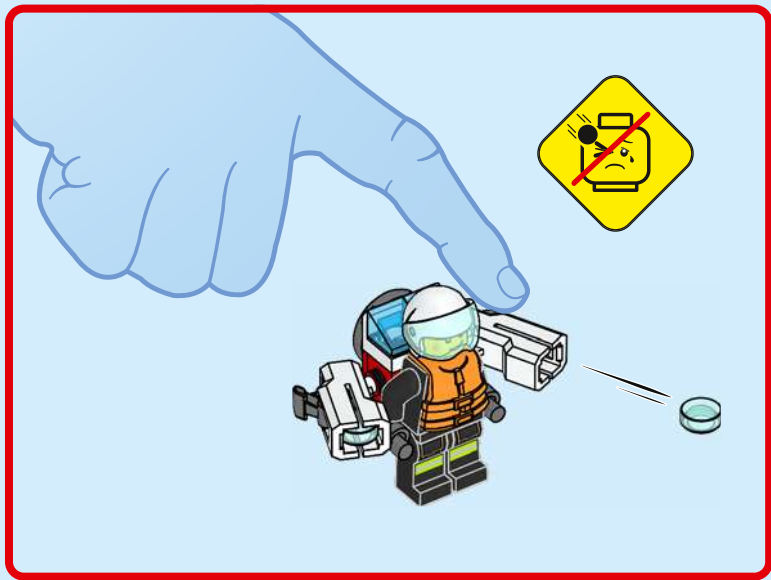

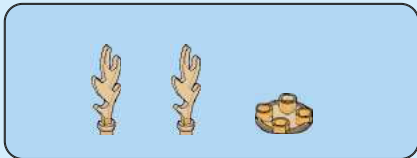

1



2

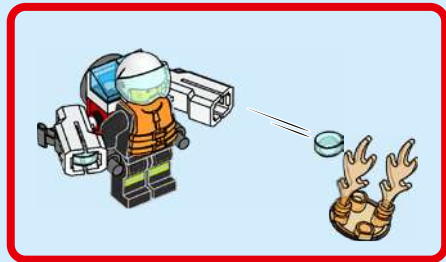

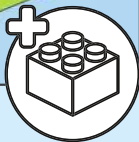
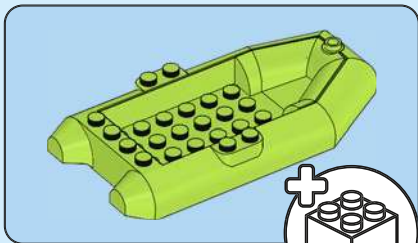
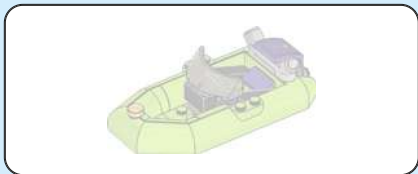

1

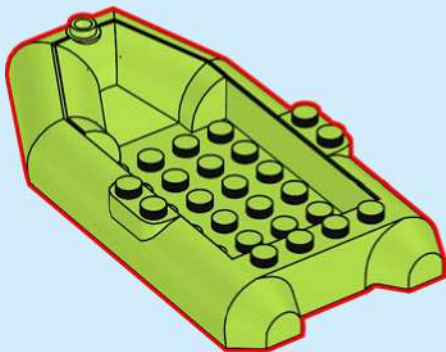



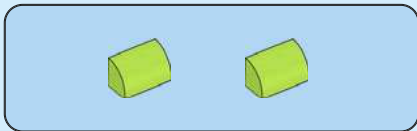

2

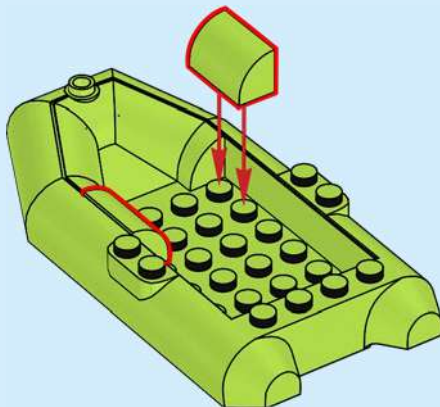

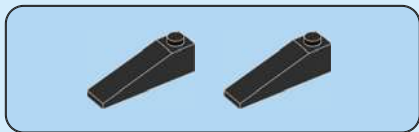

3

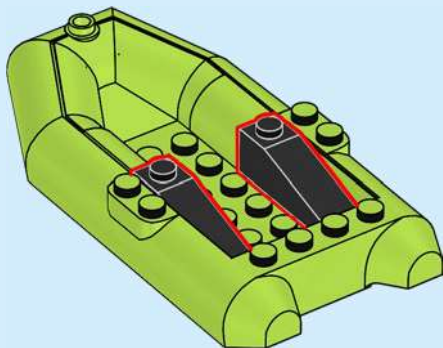

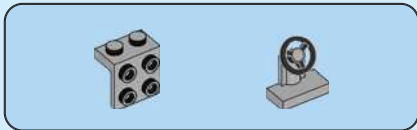

4

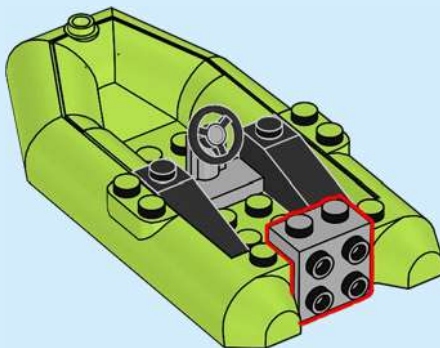



5

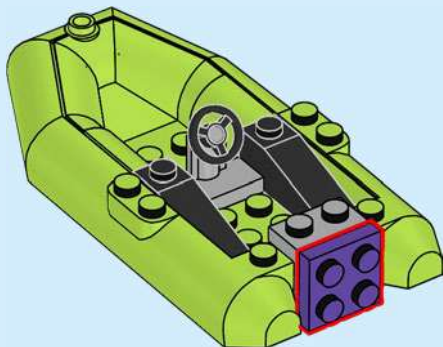



6

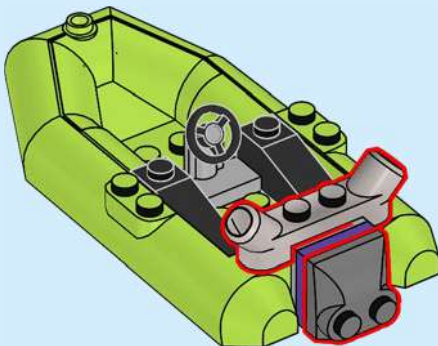



7

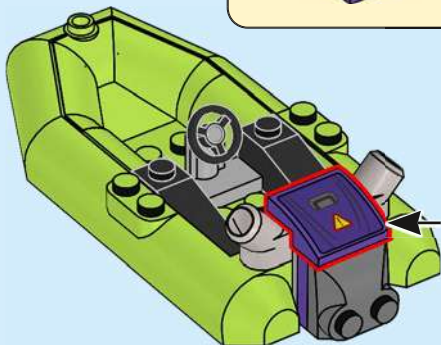
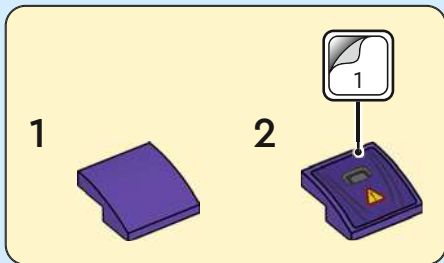



8

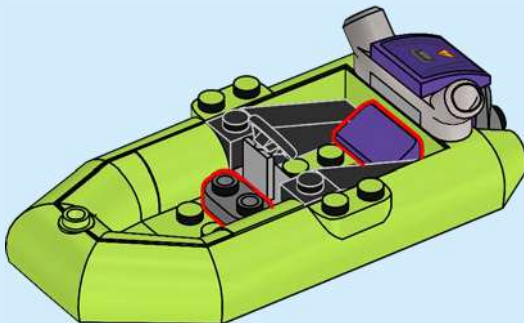



9

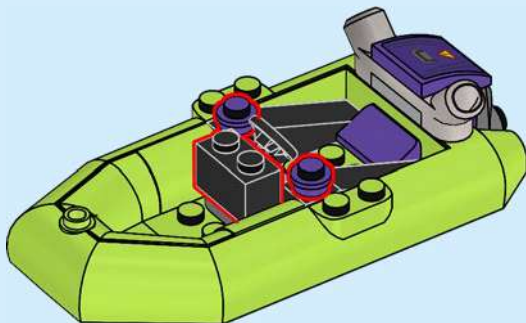



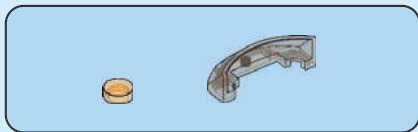

10

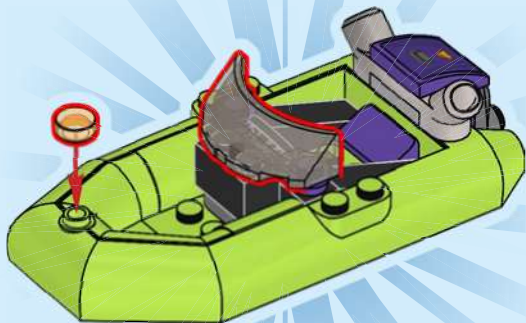



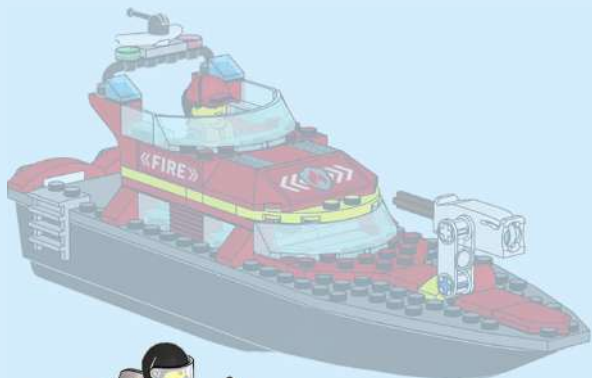

YOU COULD

WIN



Scan this QR code or go to  
**LEGO.COM/PRODUCTFEEDBACK** and give us  
your short feedback about this LEGO® set  
for a chance to win a cool LEGO prize.

Terms and Conditions apply\*

**DE: Du könntest GEWINNEN.** Es gelten die Teilnahmebedingungen\* **FR: Tu pourrais GAGNER.** Des conditions s'appliquent\* **IT: Potresti VINCERE tu.** Termini e condizioni sono applicabili\* **ES: Puedes GANAR.** Aplican términos y condiciones\* **PT: Poderá GANHAR.** Aplicam-se termos e condições\* **JA: プレゼント付き! 利用規約が適用されます\*** **ZH: 轻松获奖. 条款和条件适用\*** **KO: 상품의 주인이 되어보세요. 소정의 약관이 적용됩니다\*** **RU: Вы можете ВЫИГРАТЬ.** Действуют положения и условия\* **PL: Szansa na WYGRANĄ.** Obowiązują warunki korzystania\* **CS: Máte šanci VYHRÁT.** Platí všeobecné smluvní podmínky\* **SK: Máte šancu VYHRÁŤ.** Platia všeobecné zmluvné podmienky\* **HU: TE IS NYERHETSZ.** Felhasználási feltételek érvényesek\* **RO: Ai putea CÂȘTIGA.** Se aplică termenii și condiții\* **BG: Можете да СПЕЧЕЛИТЕ.** Има определени правила и условия\* **LV: Tu vari LAIMĒT.** Ir spēkā noteikumi un nosacījumi.\* **ET: Sul on võimalus VÕITA.** Kehtivad tingimused\* **LT: Jūs galite LAIMĖTI.** Taikomos sąlygos\*

\*[LEGO.com/productfeedback-terms](https://www.lego.com/productfeedback-terms)



CITY

60373



2

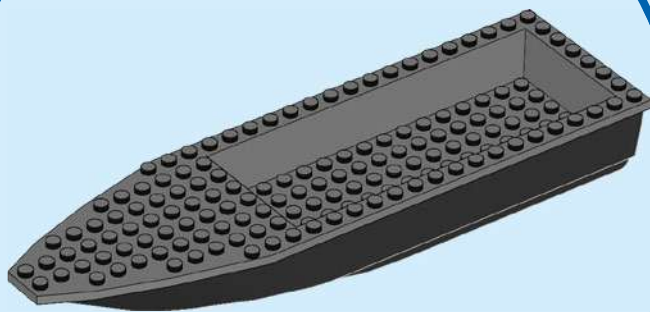
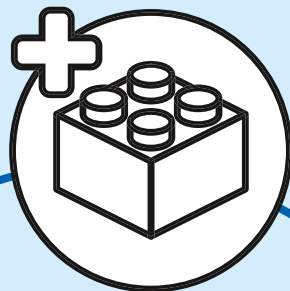
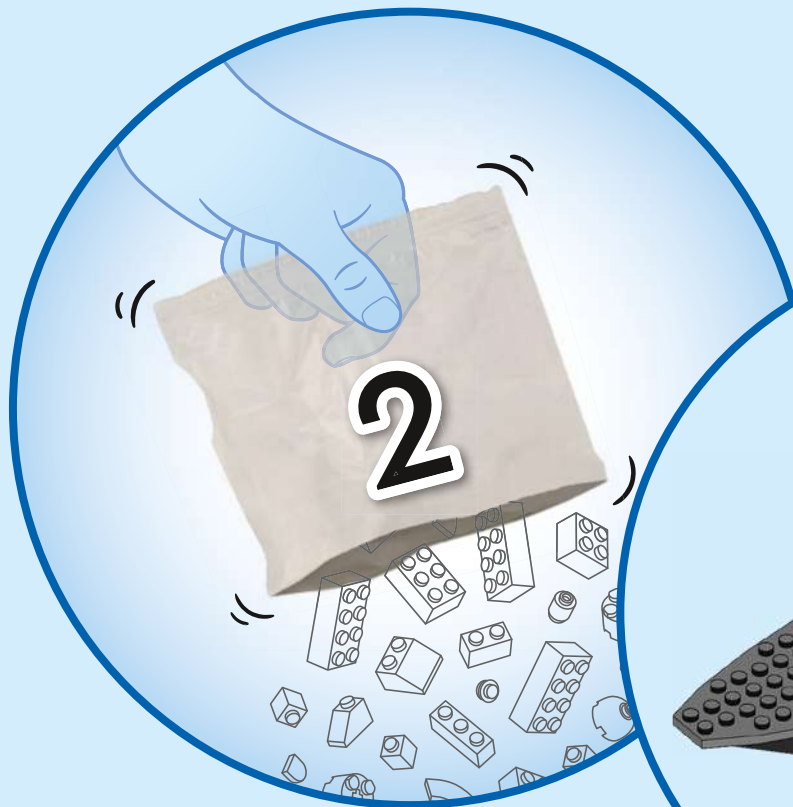

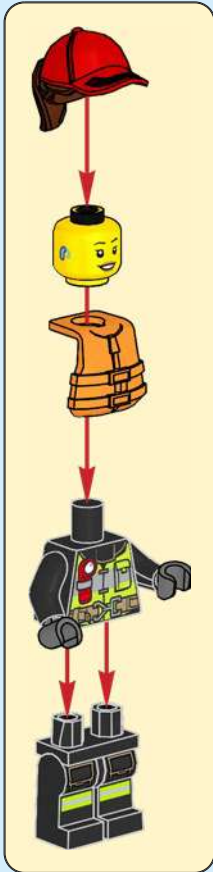

1

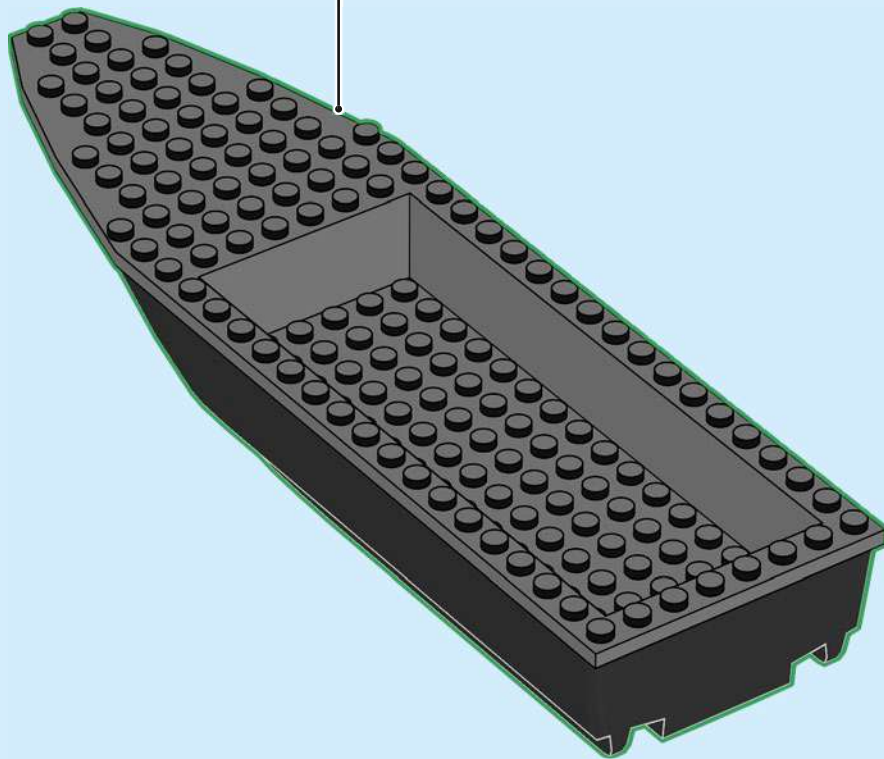
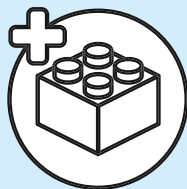



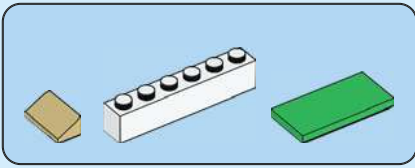

2

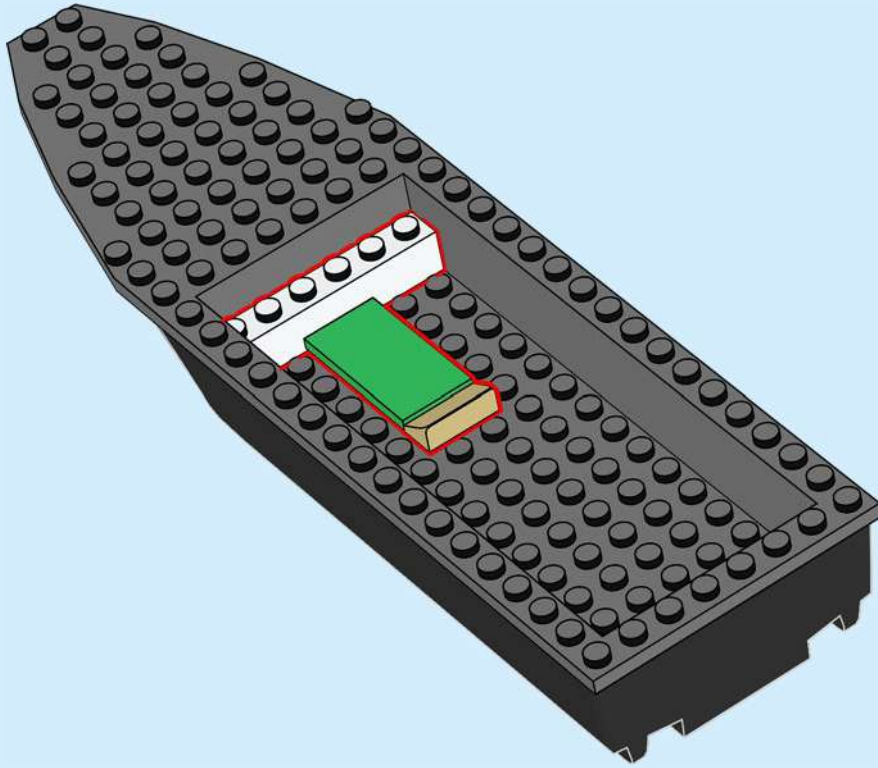

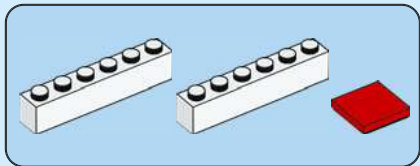

3

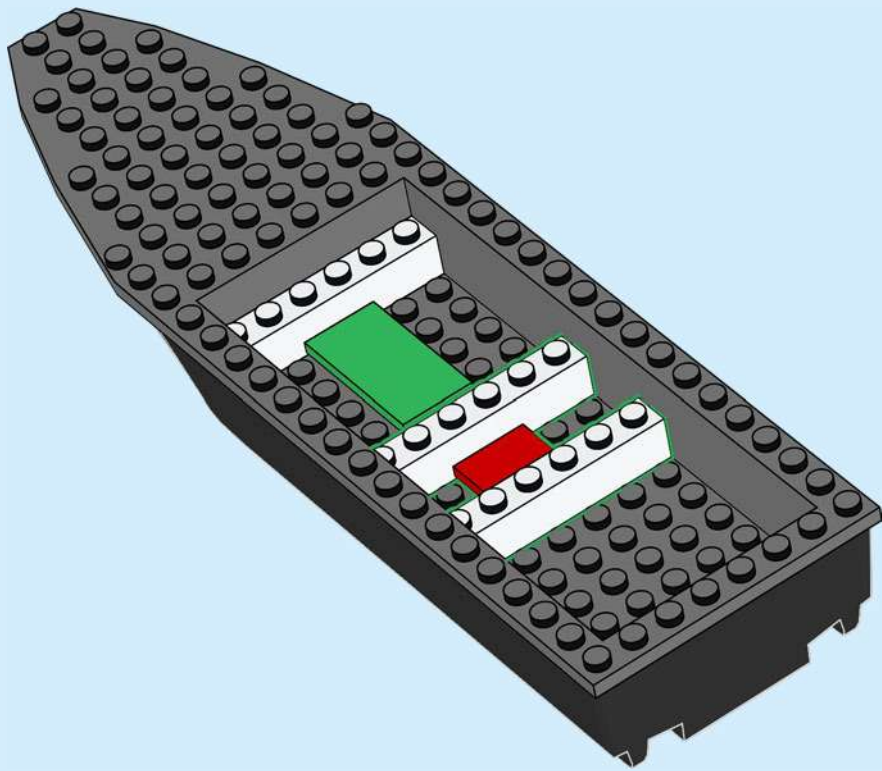

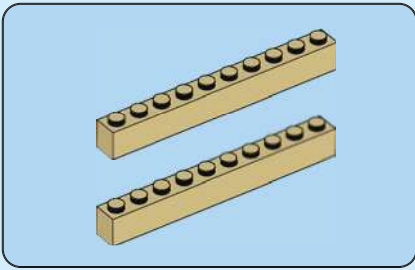

4

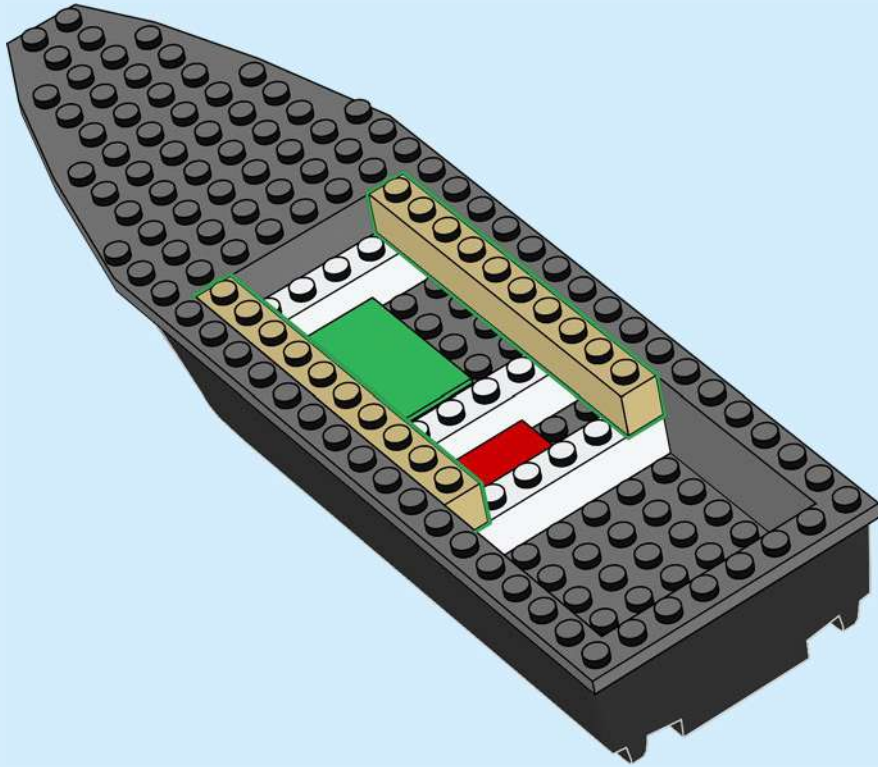

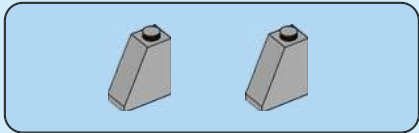

5

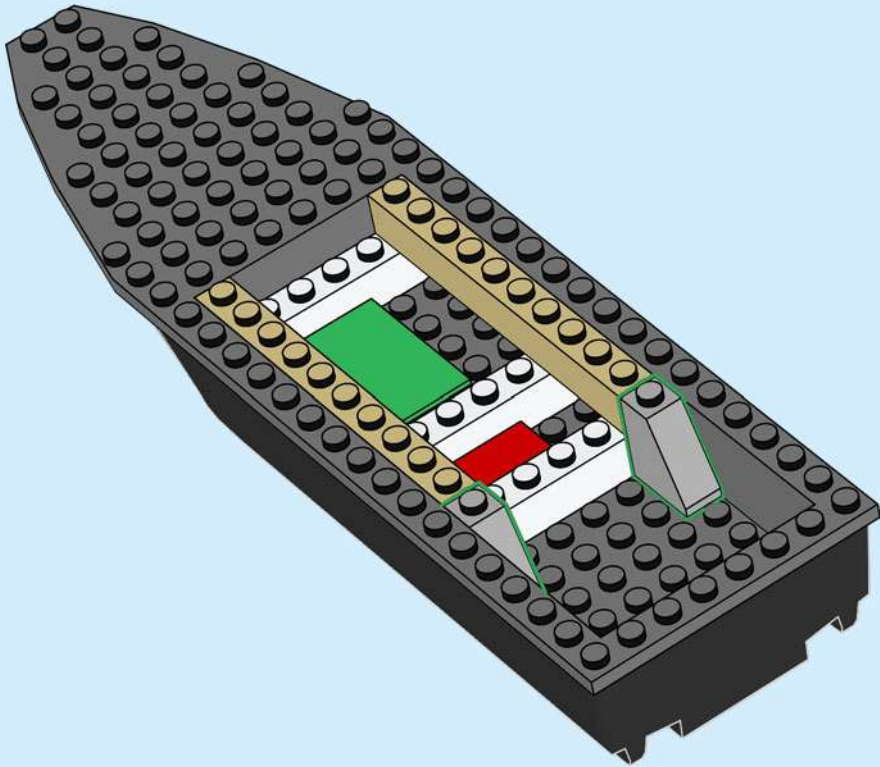

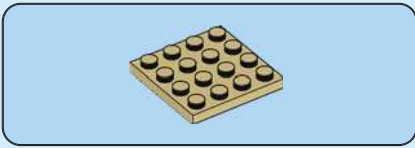

6

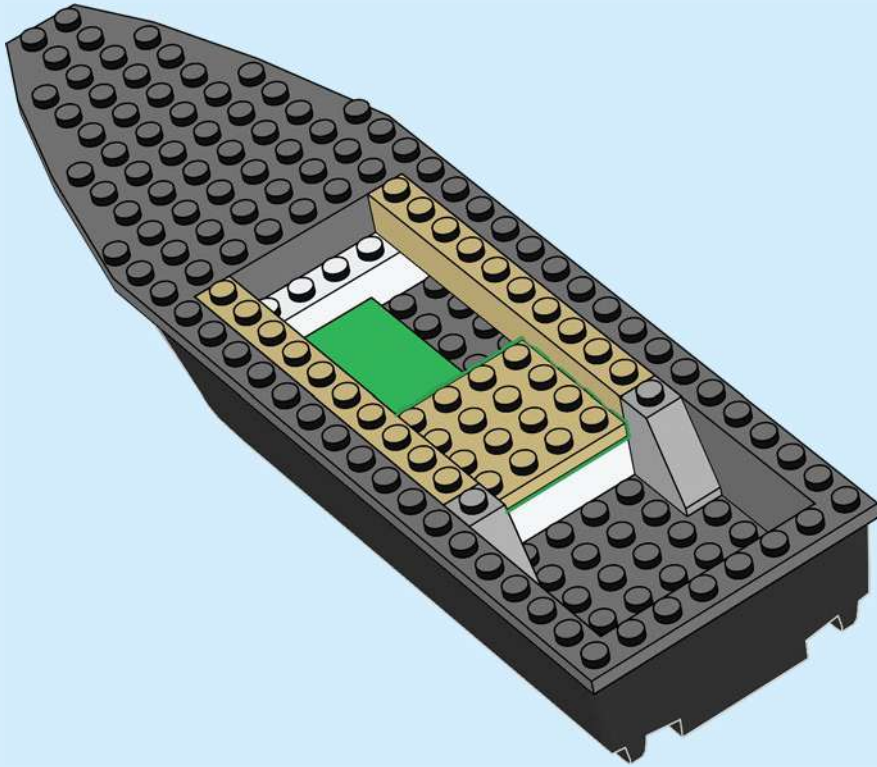

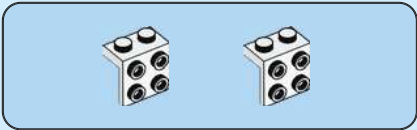

7

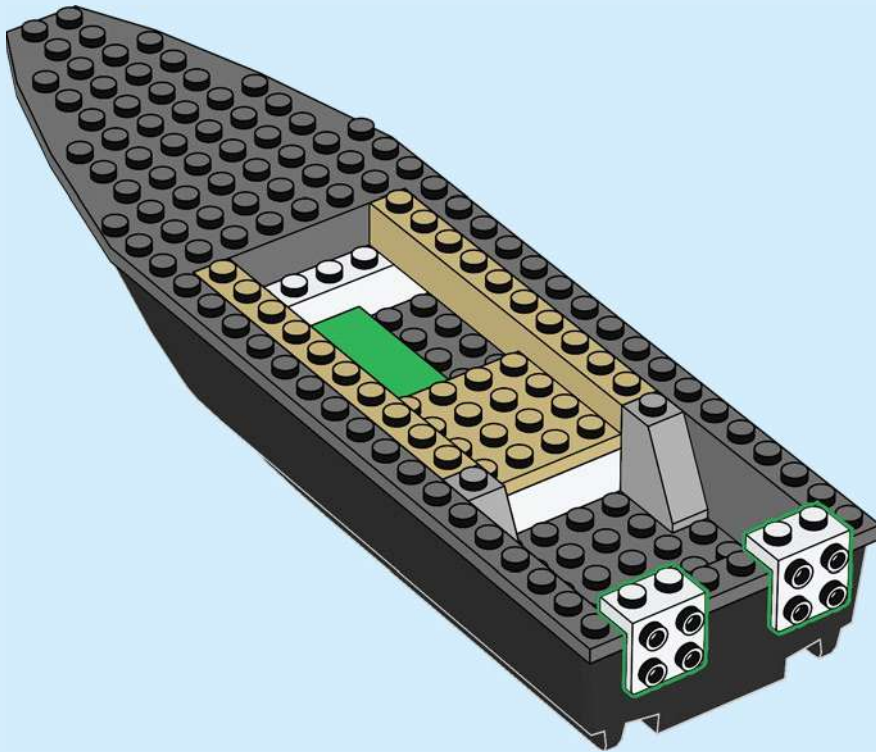

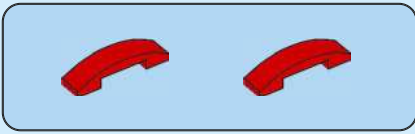

8

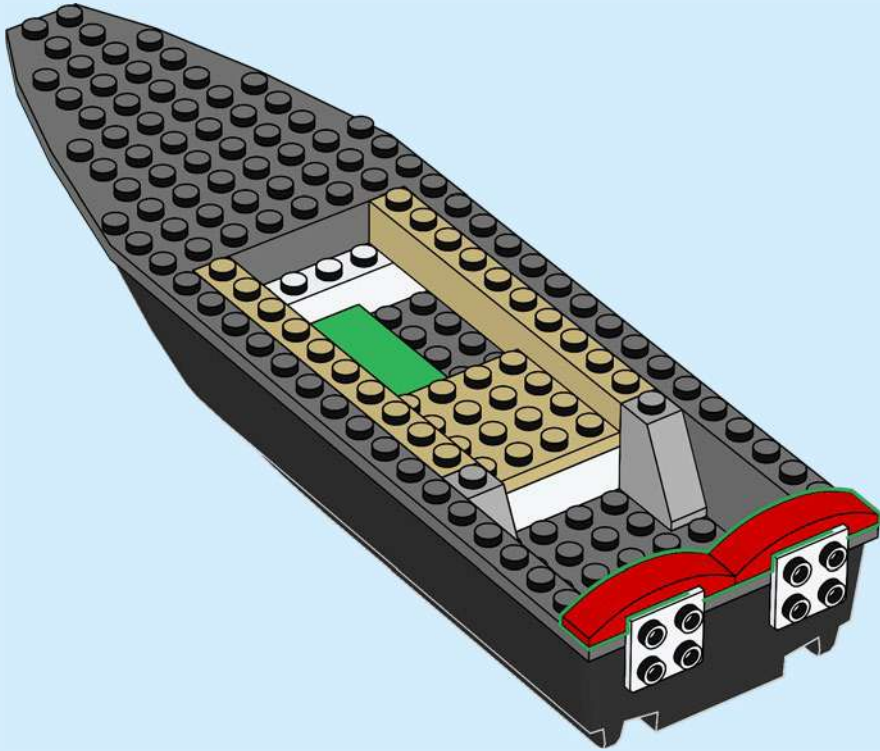

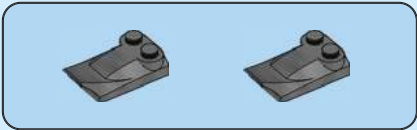

9

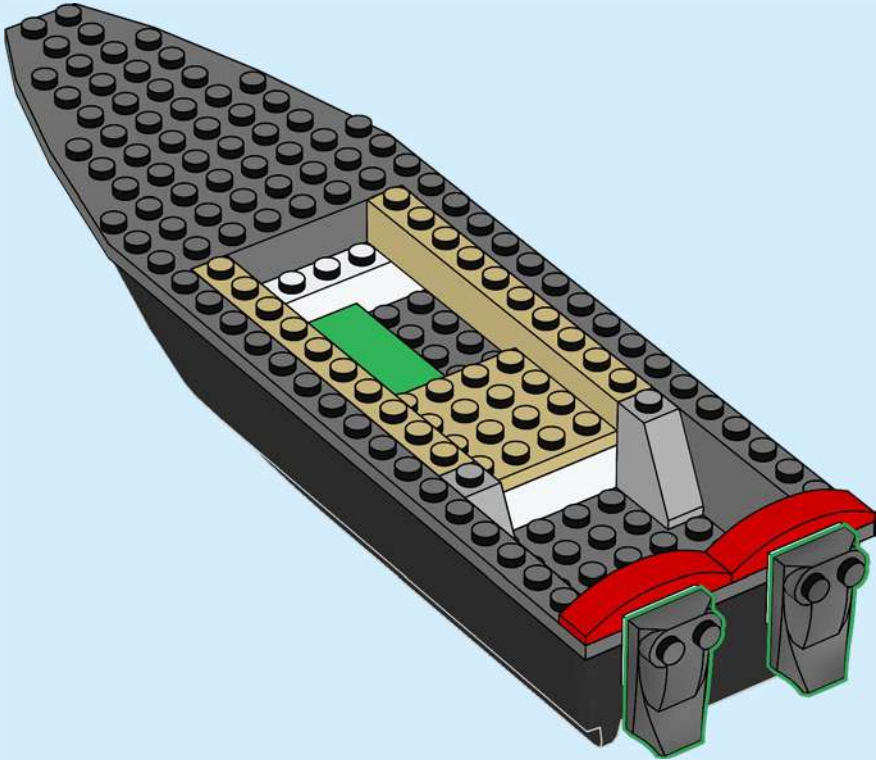



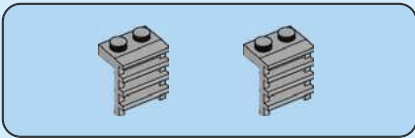

10

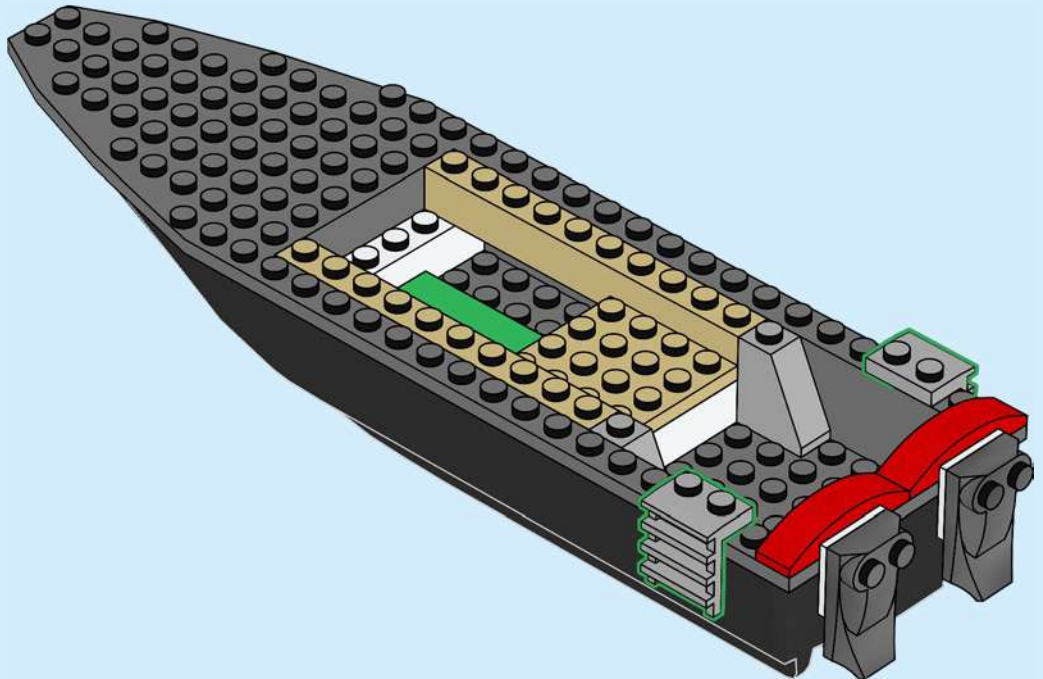

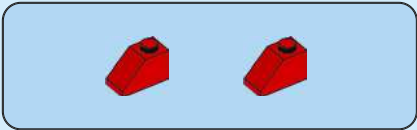

11

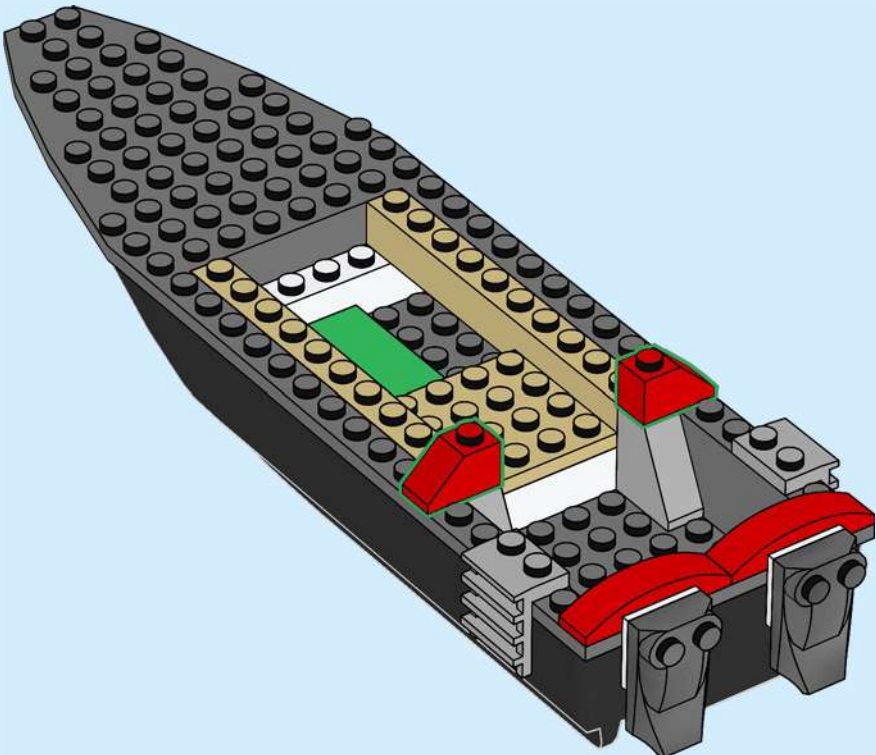

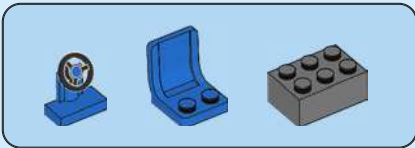

12

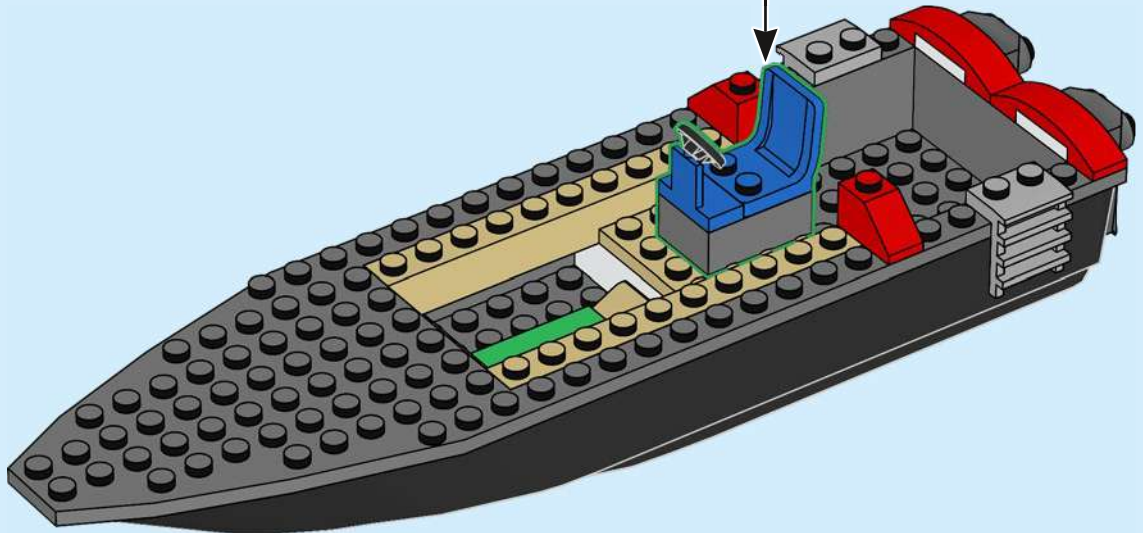
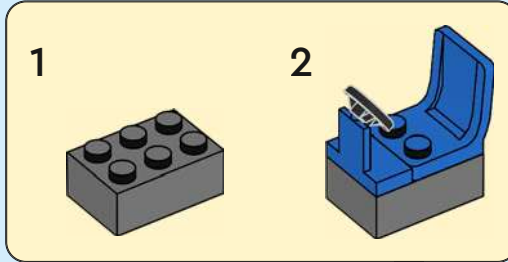

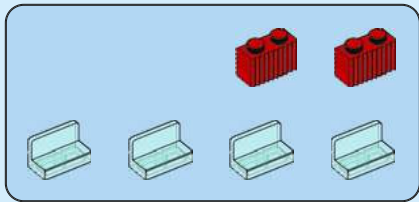

13

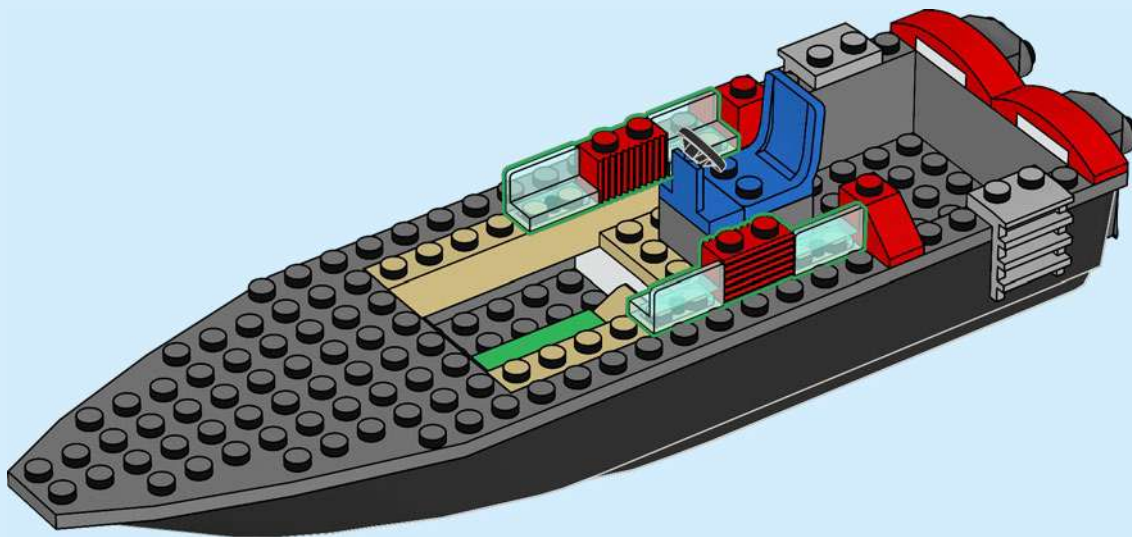

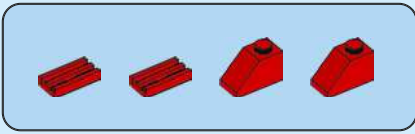

14

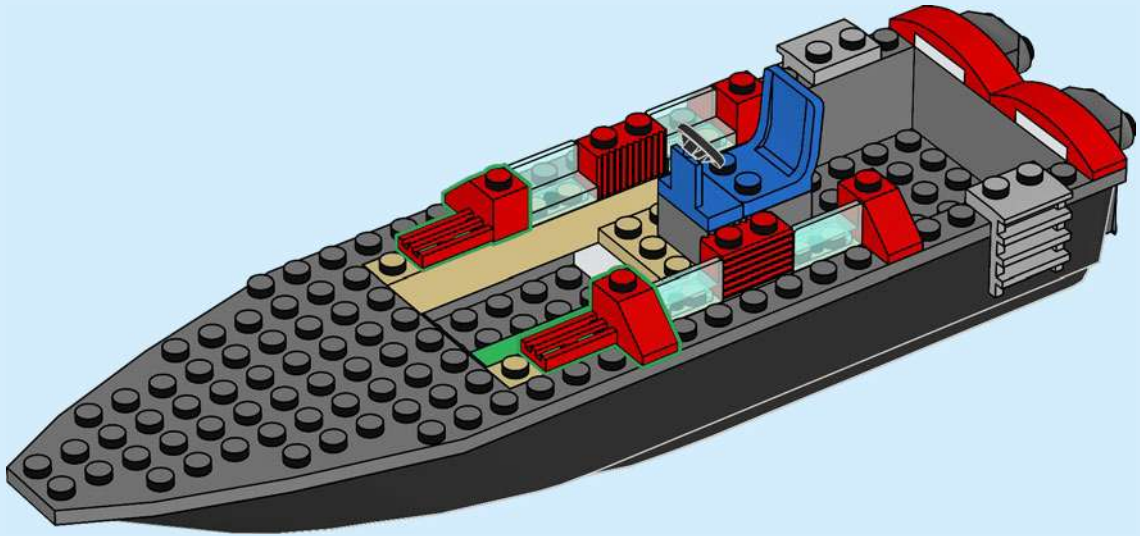

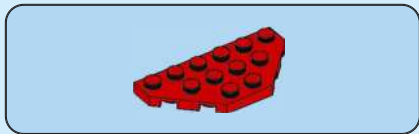

15

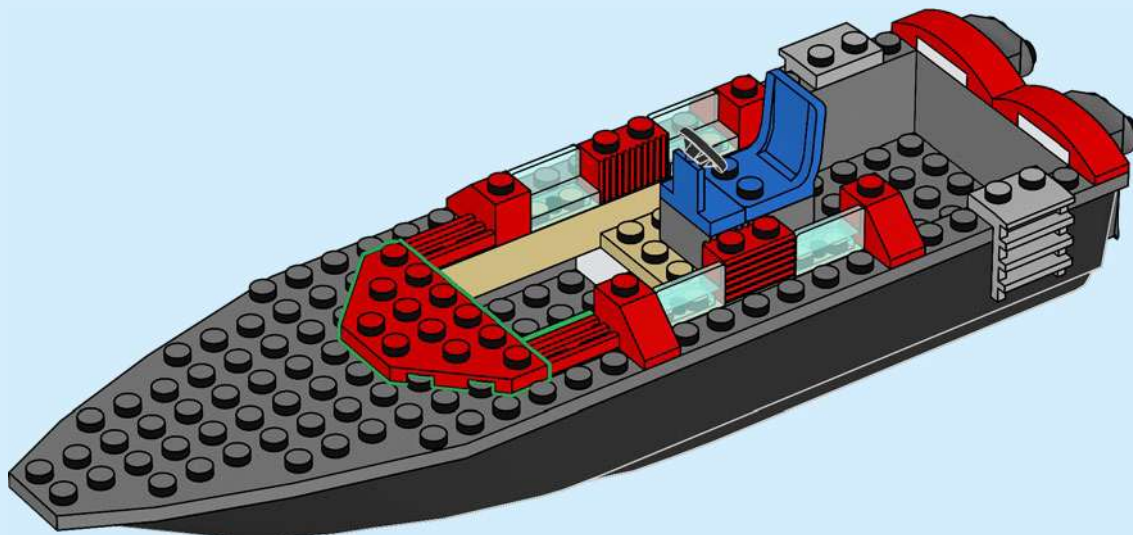

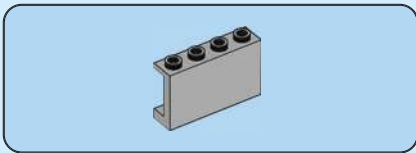

16

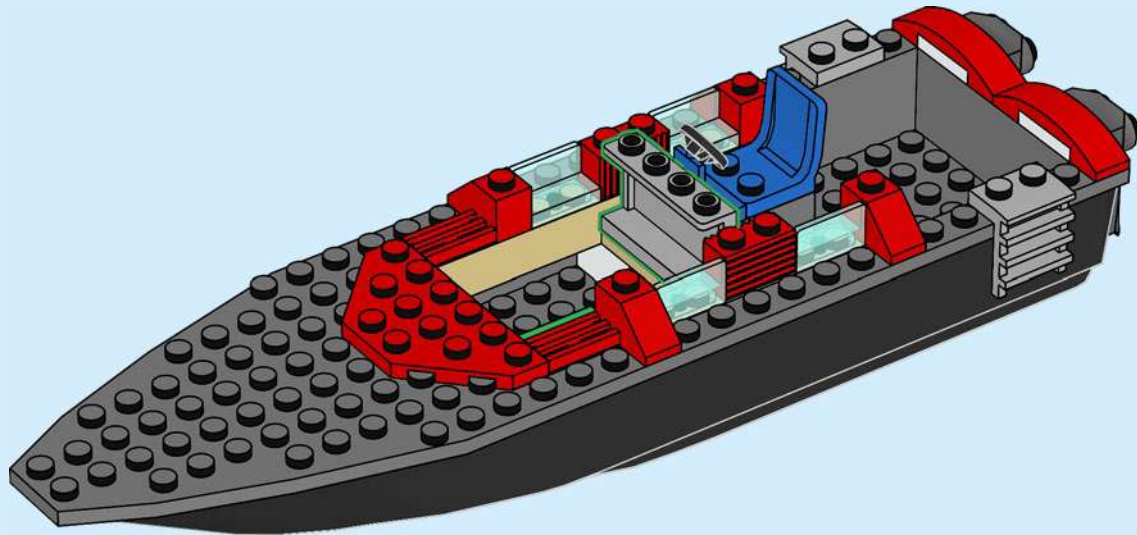

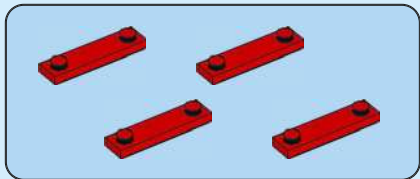

17

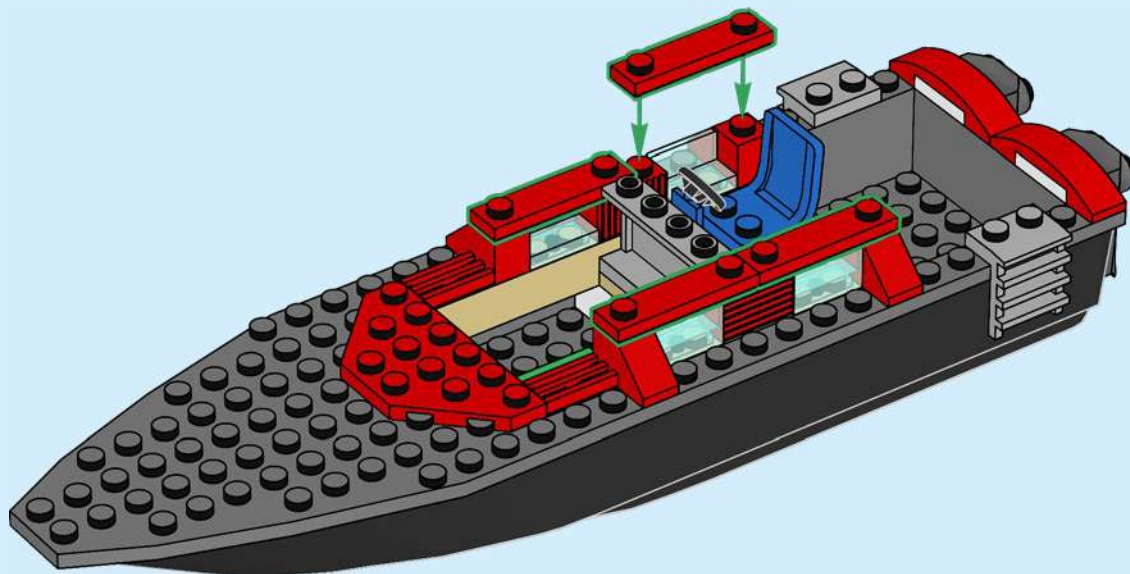



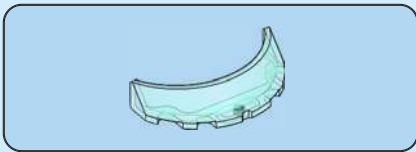

18

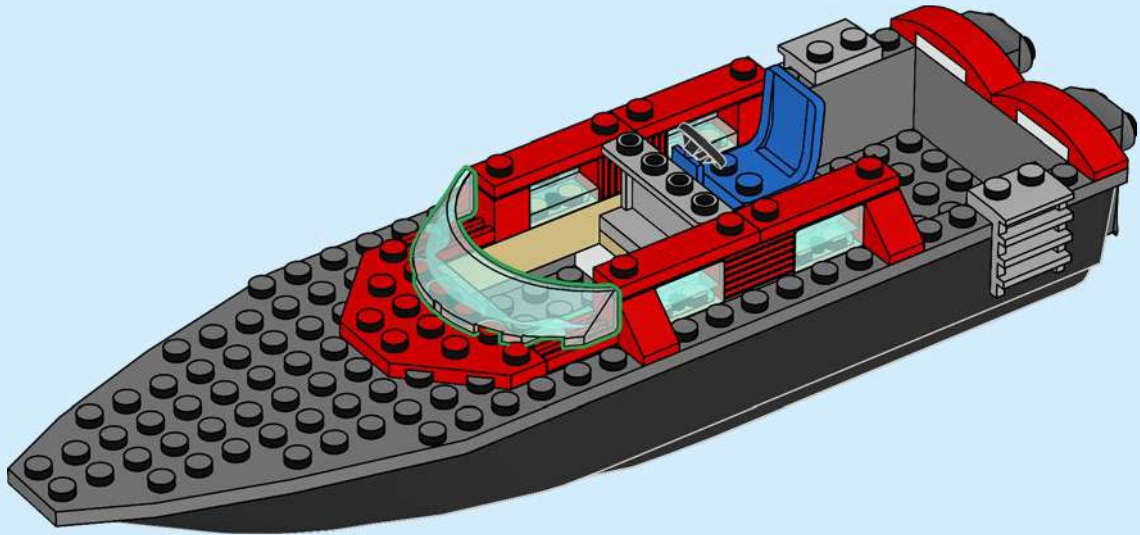

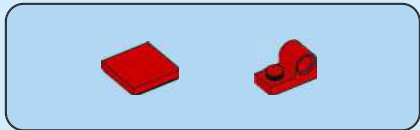

19

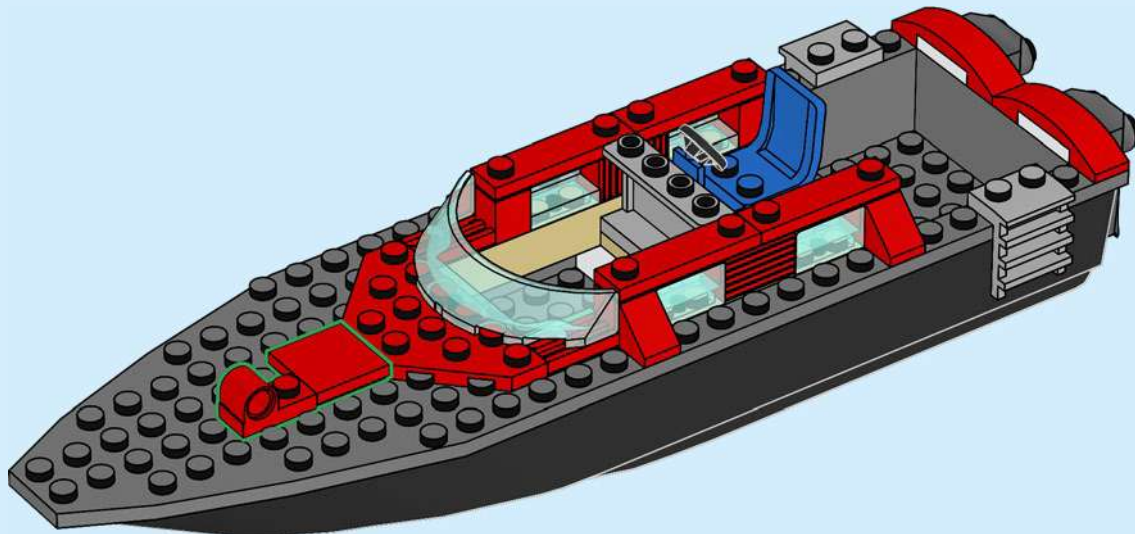

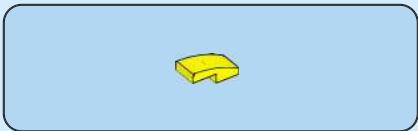

20



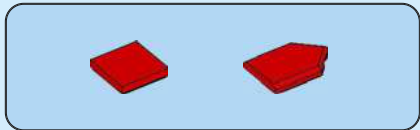

21

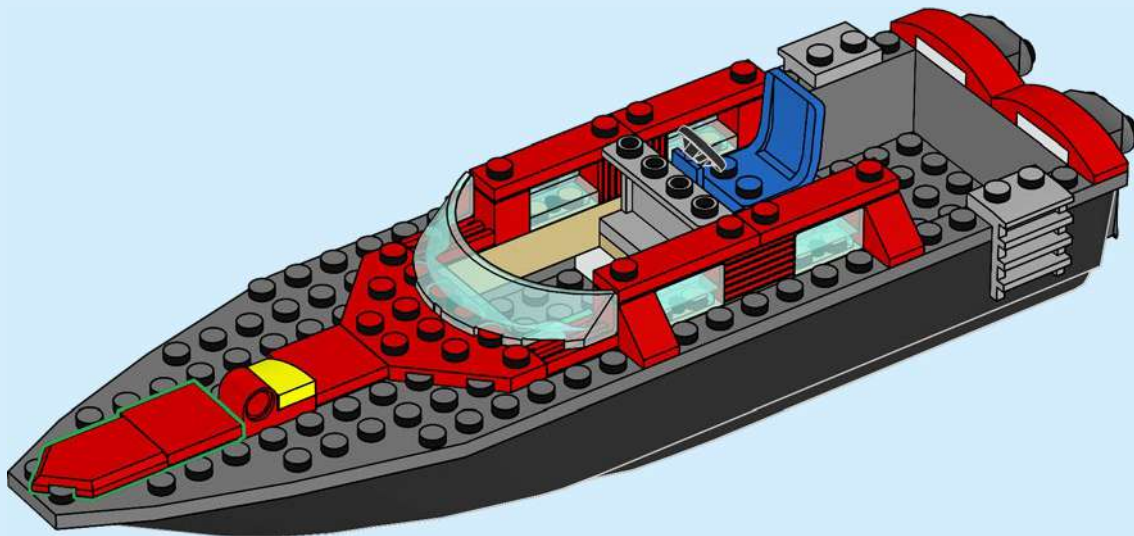

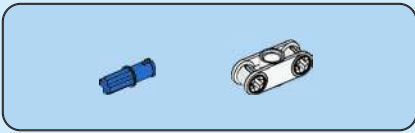

22

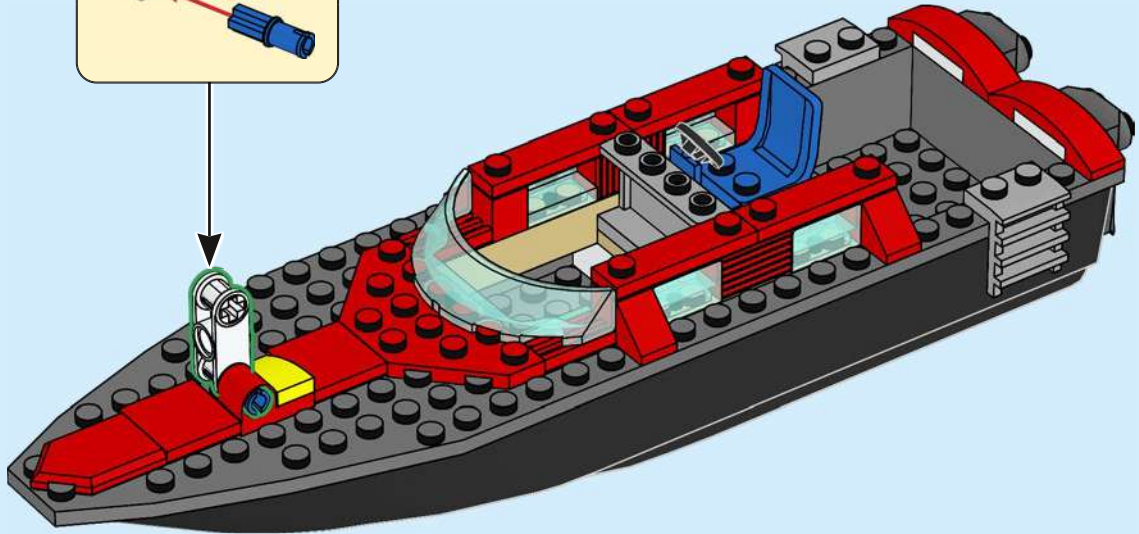
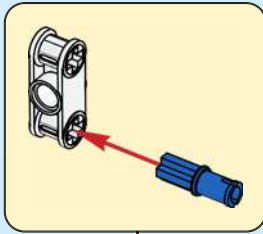

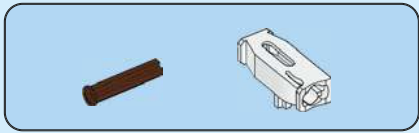

23

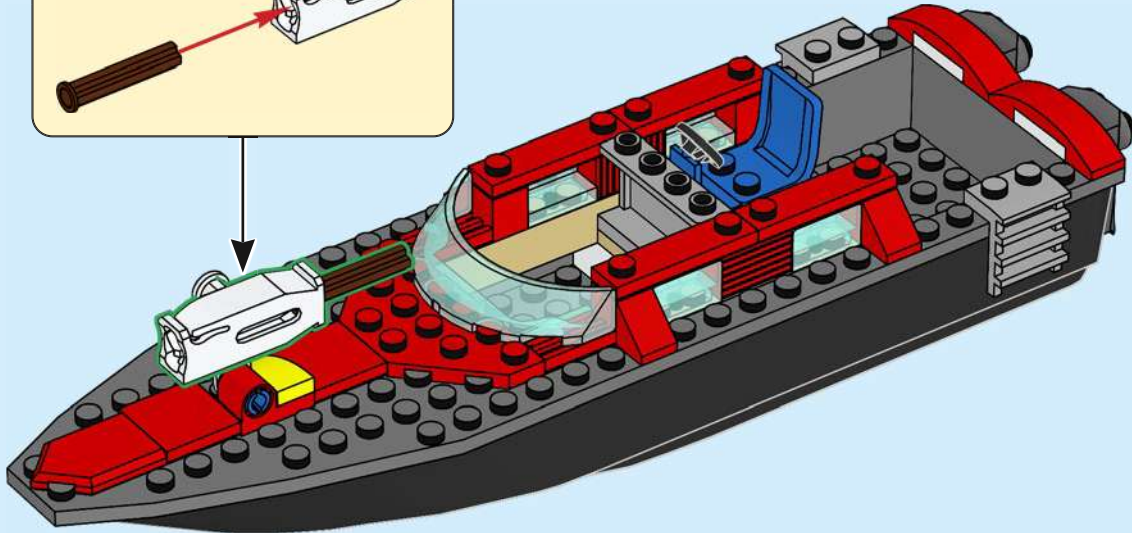
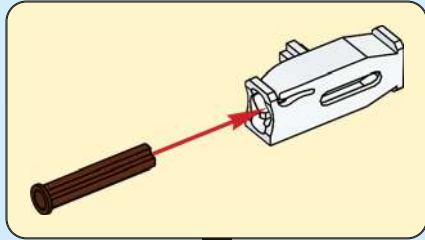

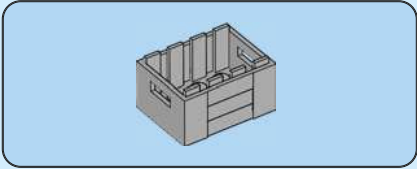
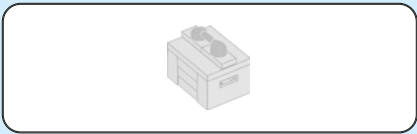

24

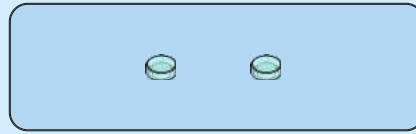
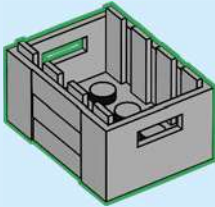

25

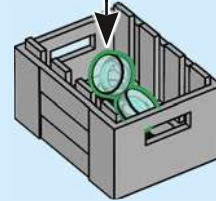

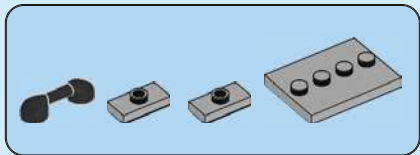

26

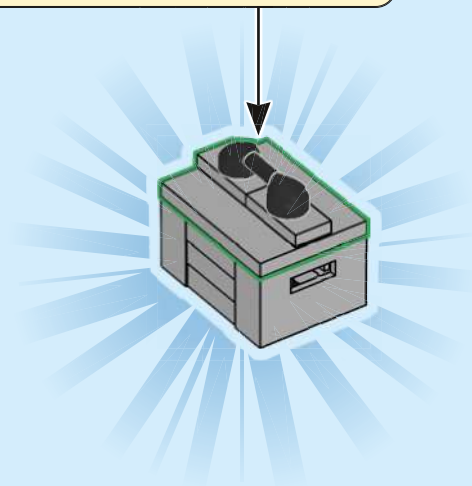
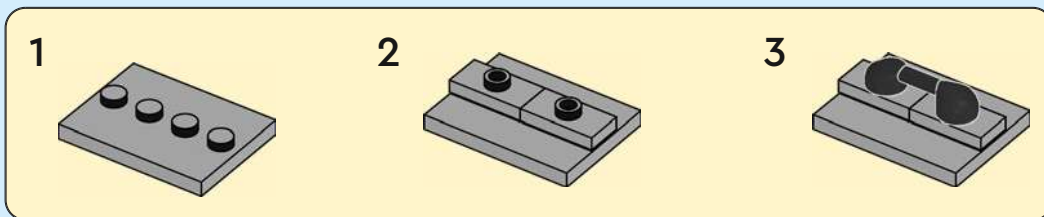



27

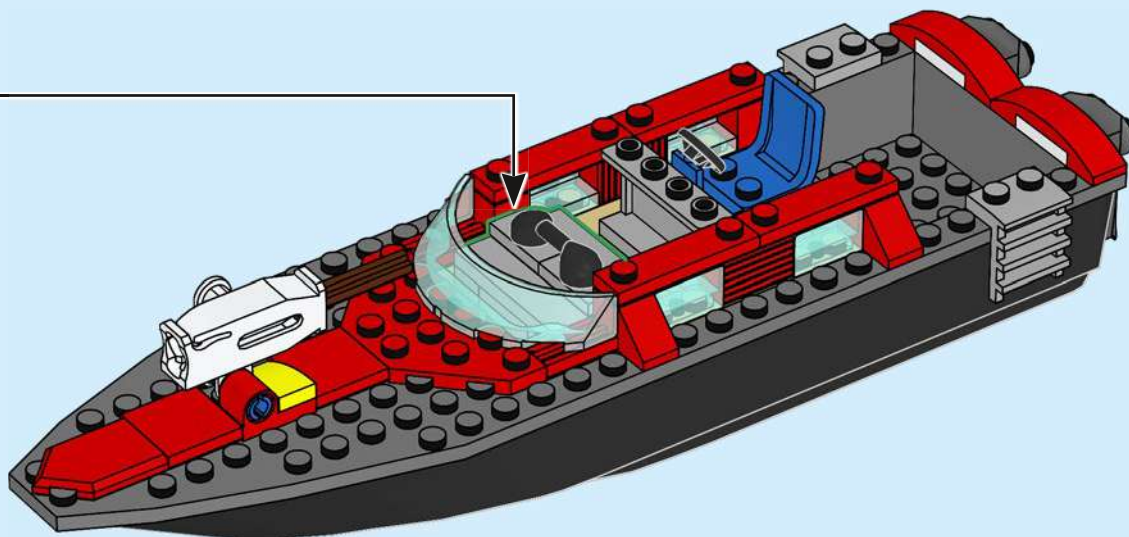

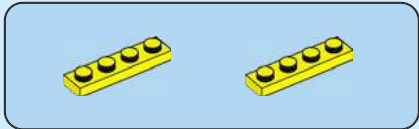

28

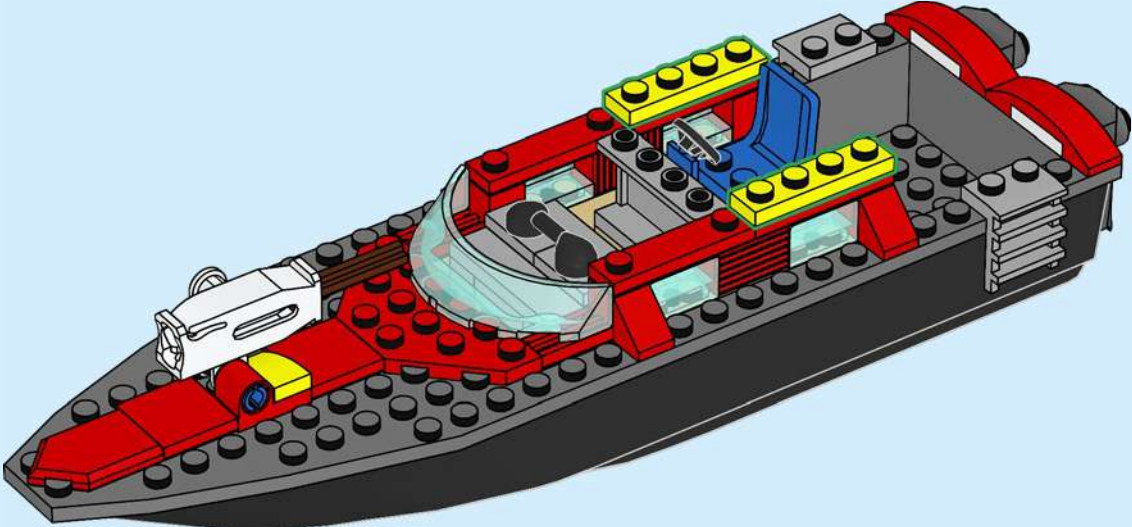



29

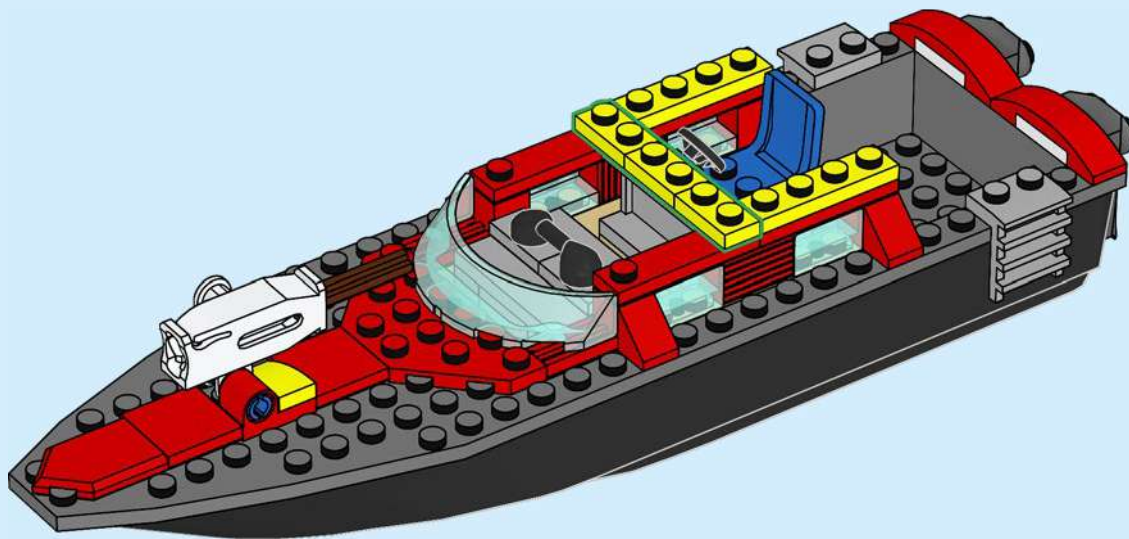

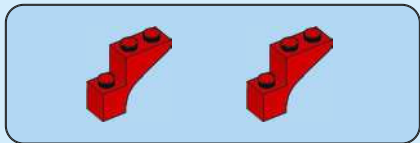

30

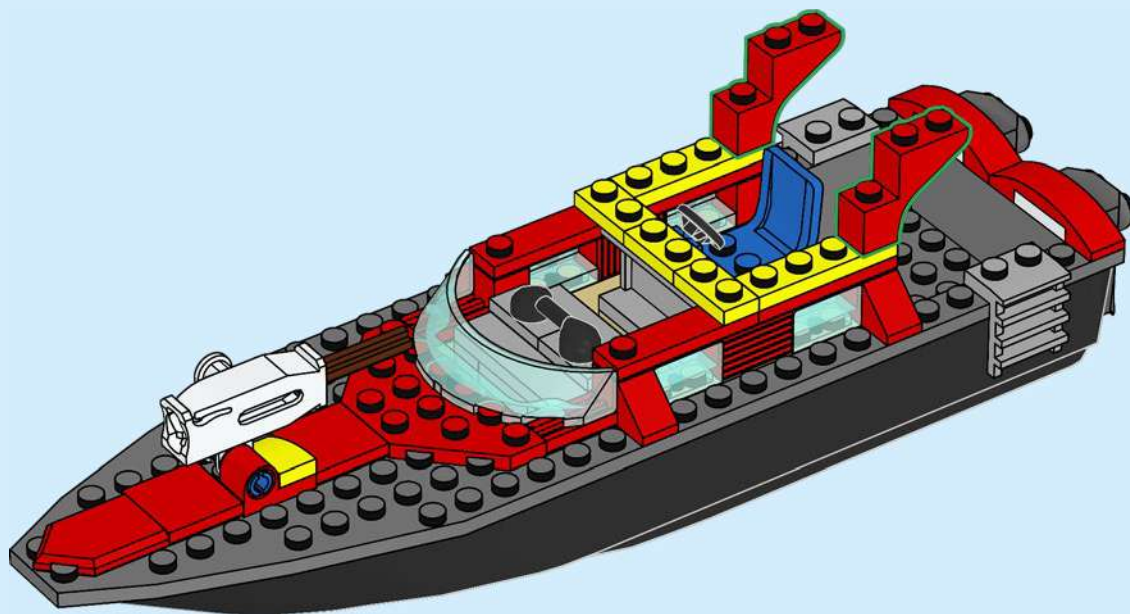

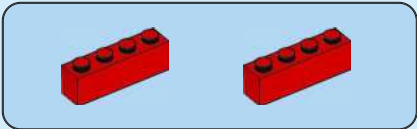

31

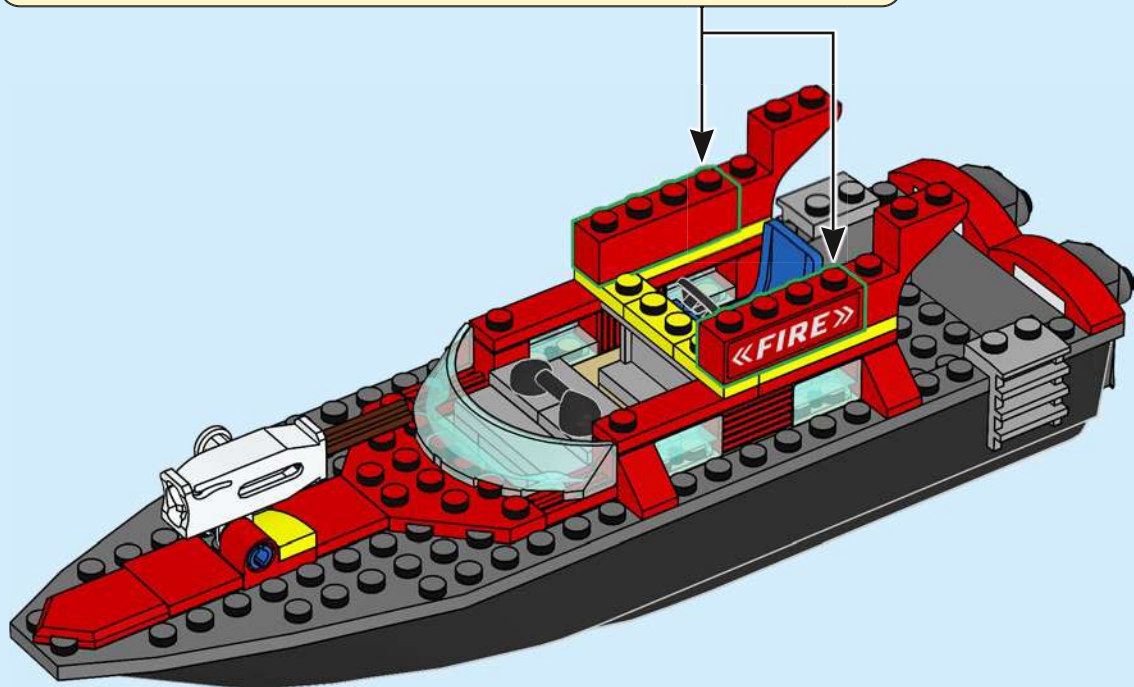
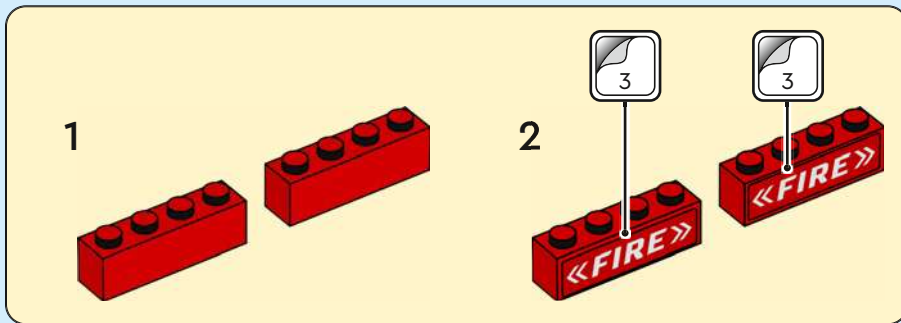

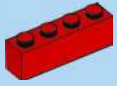

32

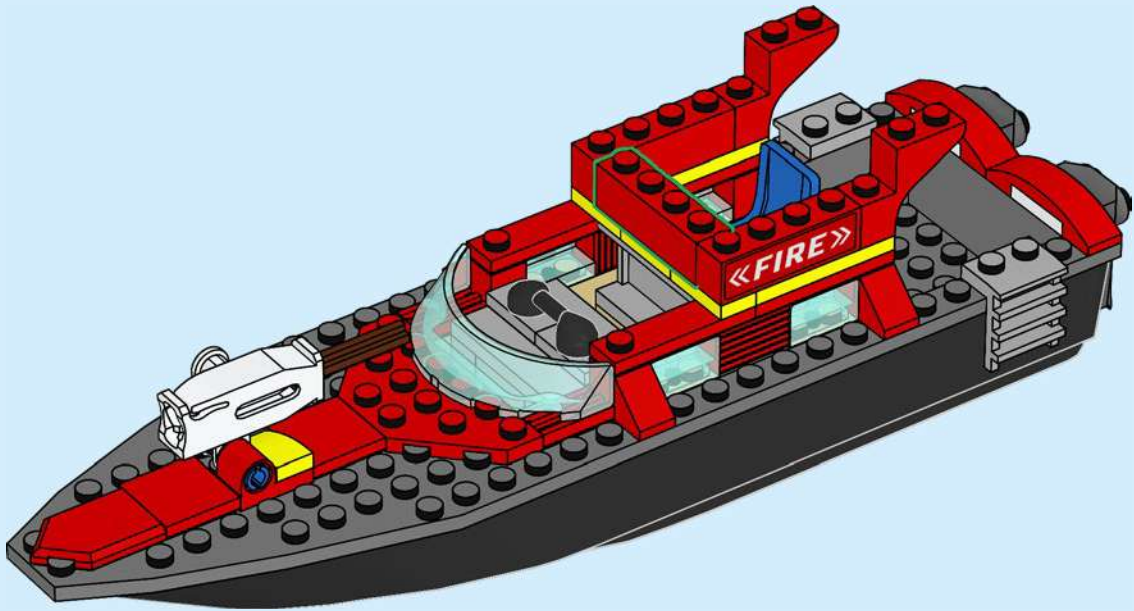

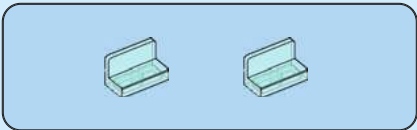

33

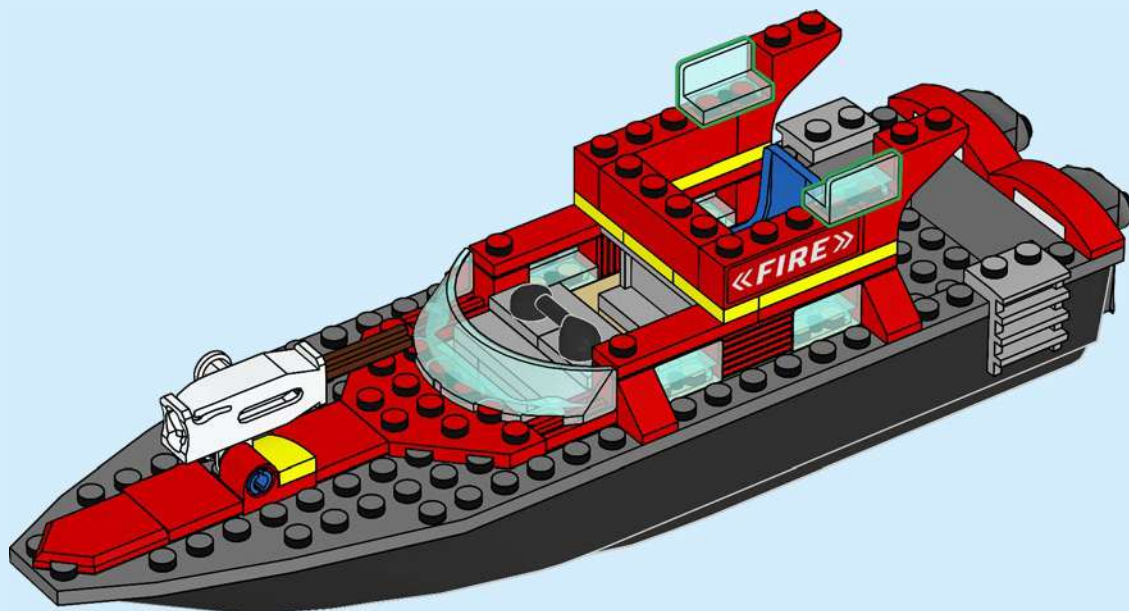

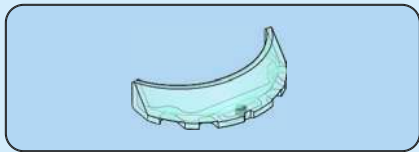

34

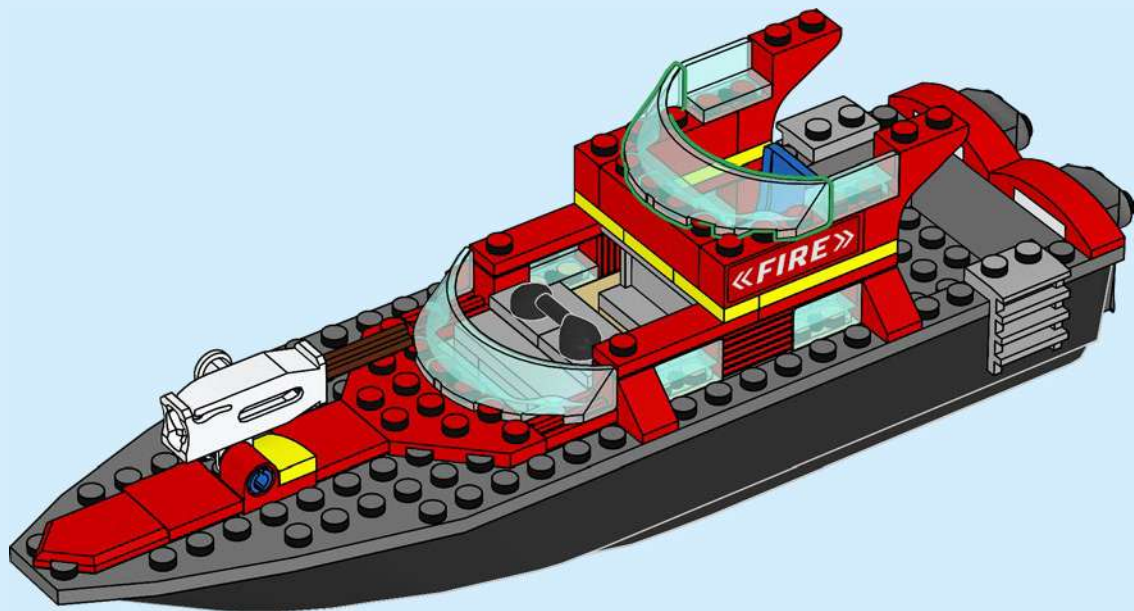





35

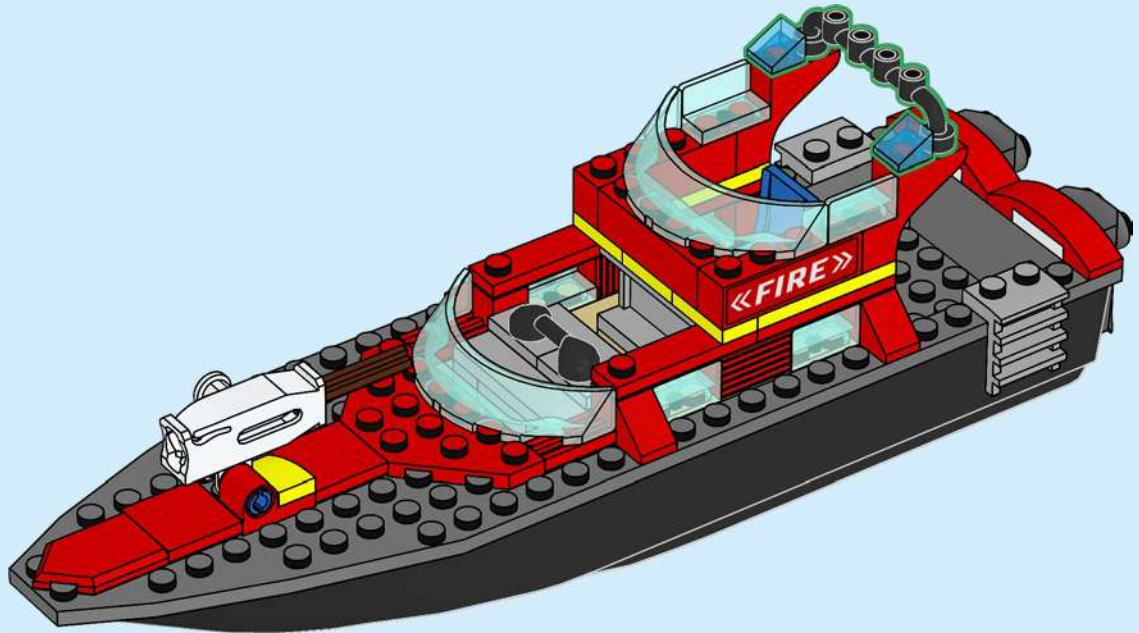



36

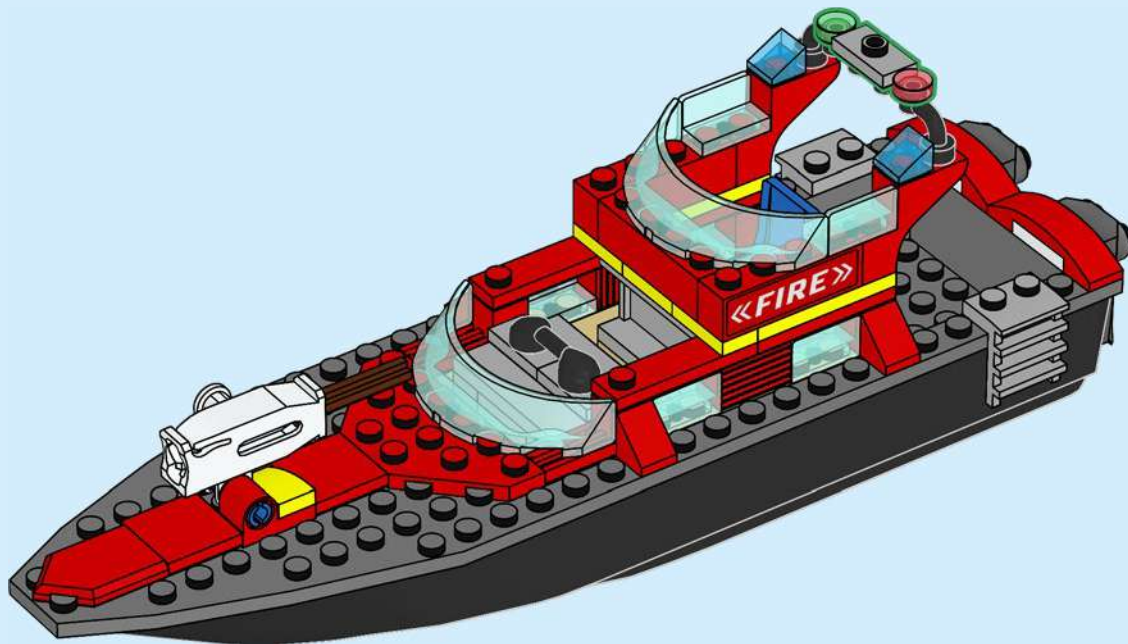

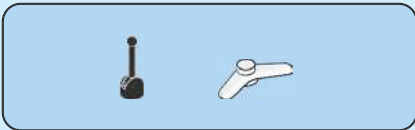

37

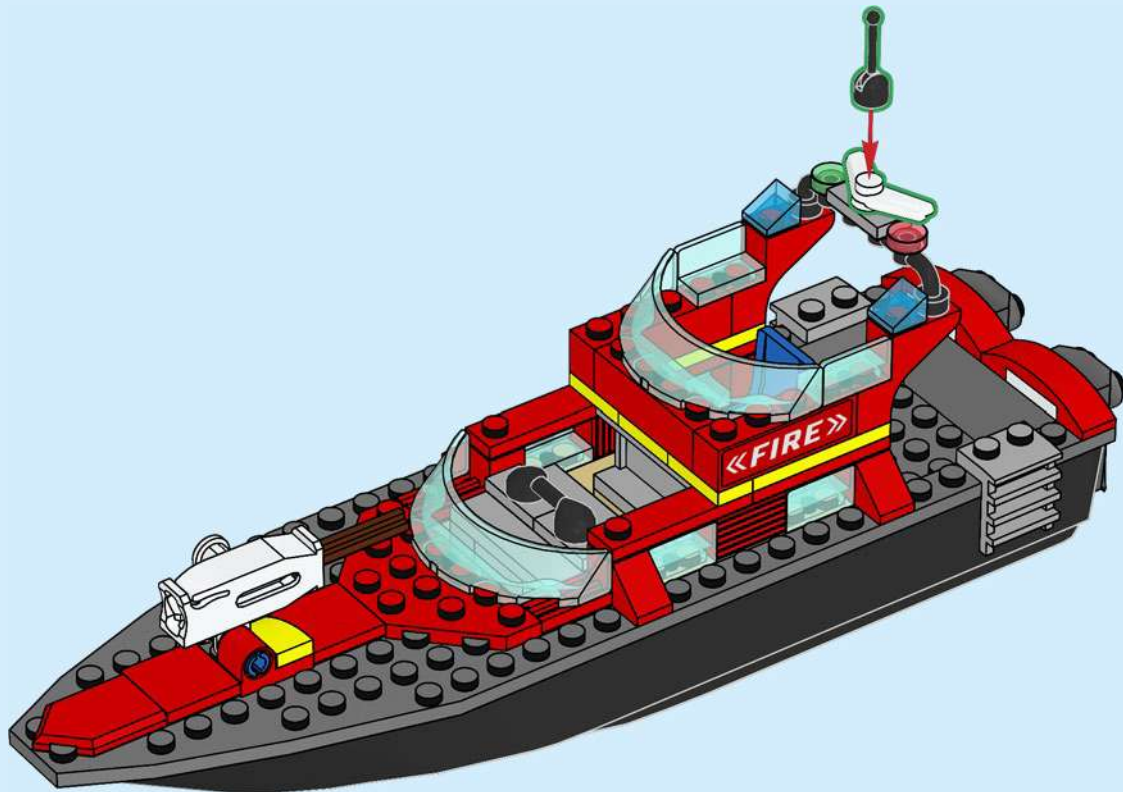

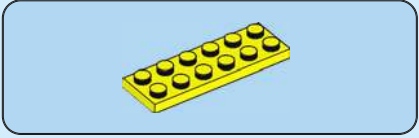

38

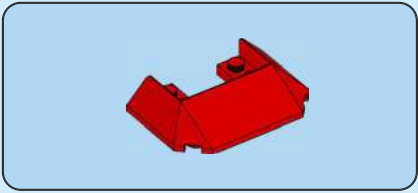
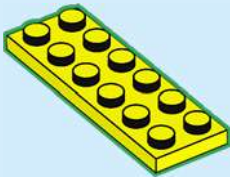

39

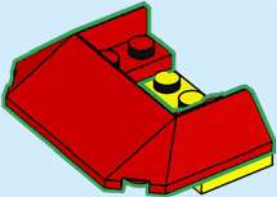

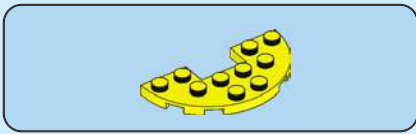

40

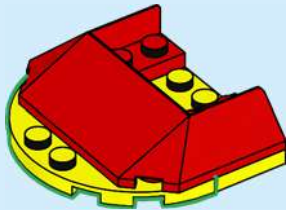

41

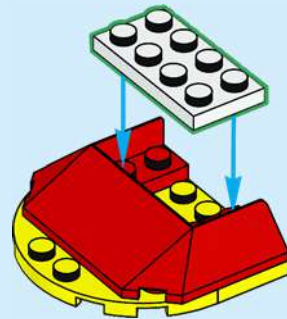



42

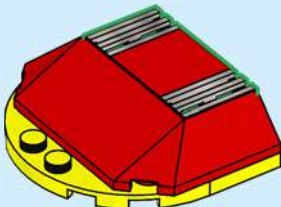

43



44

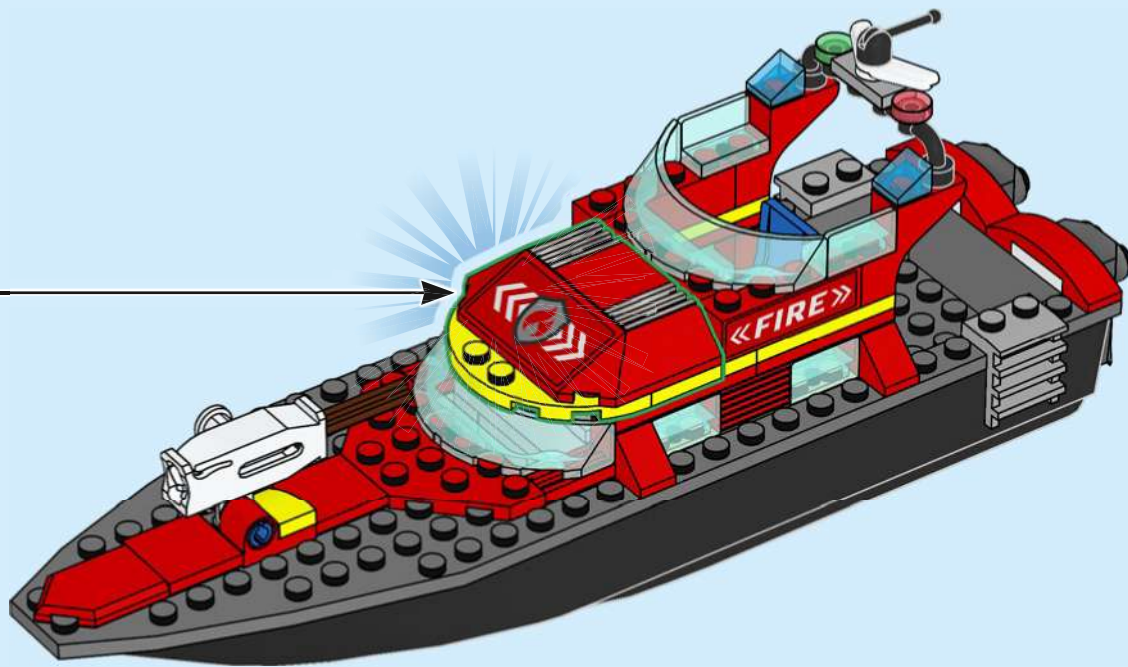



45

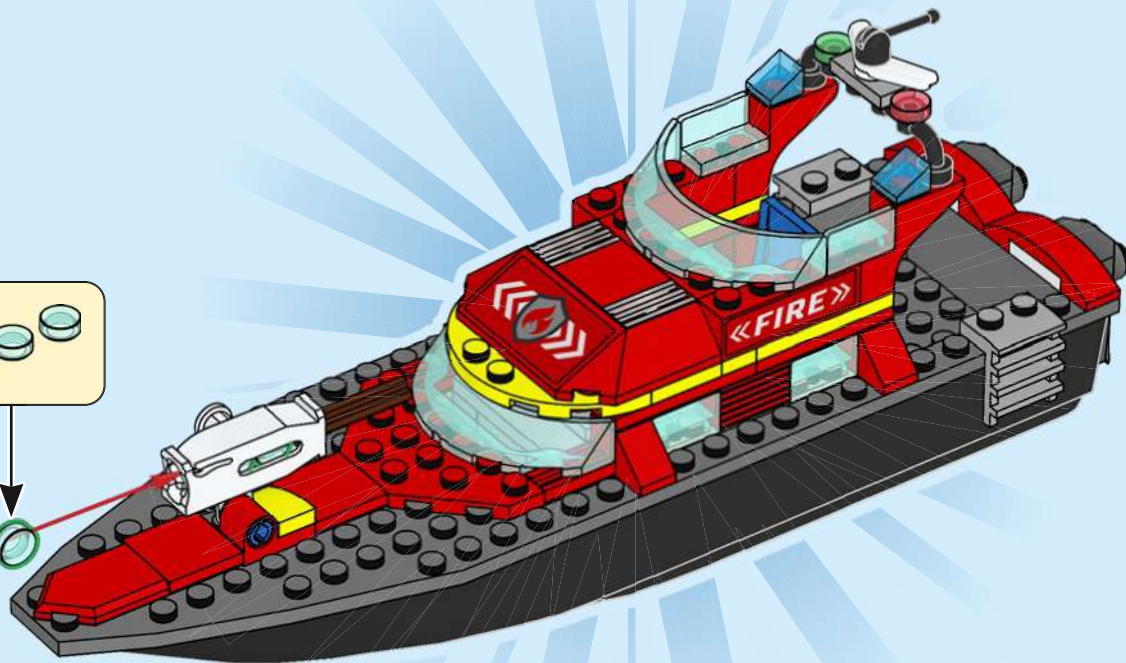



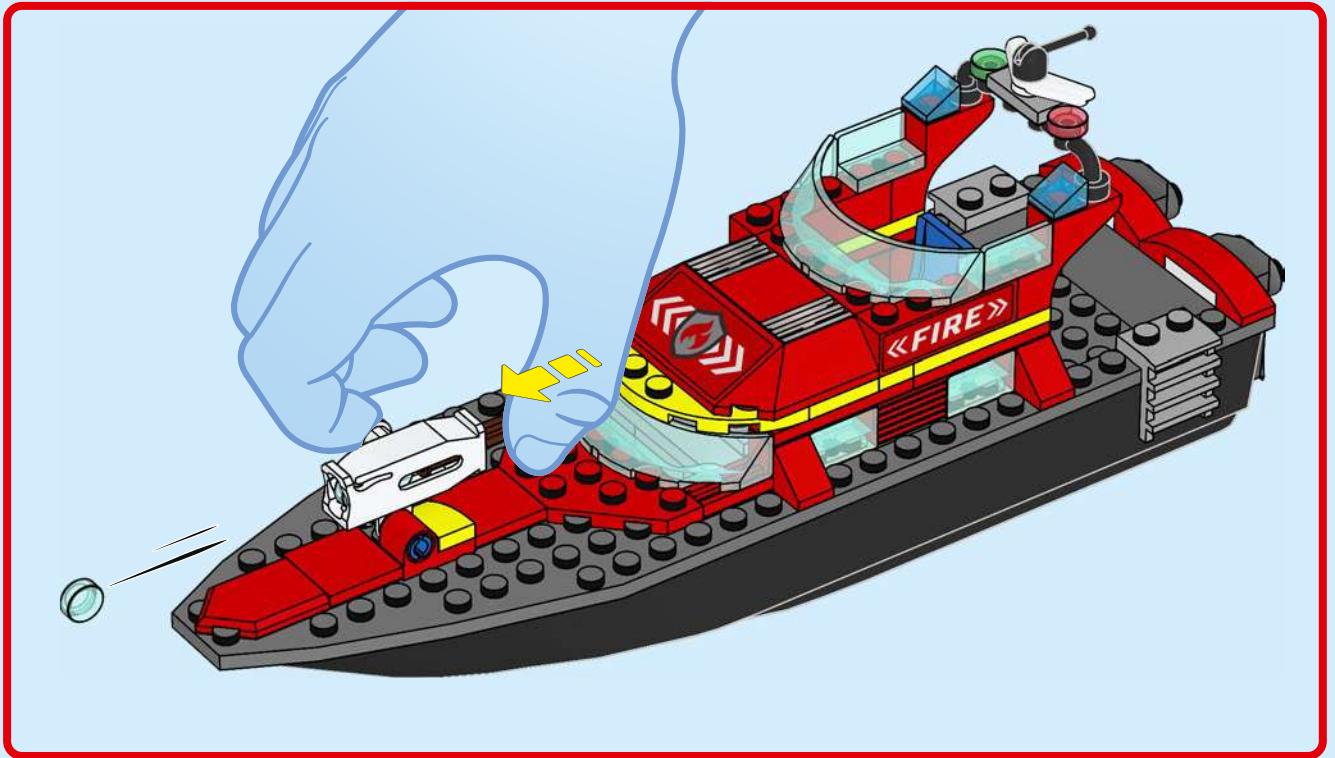





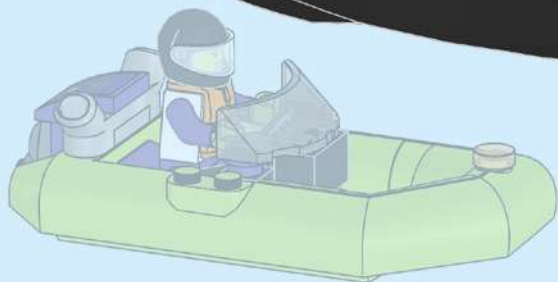
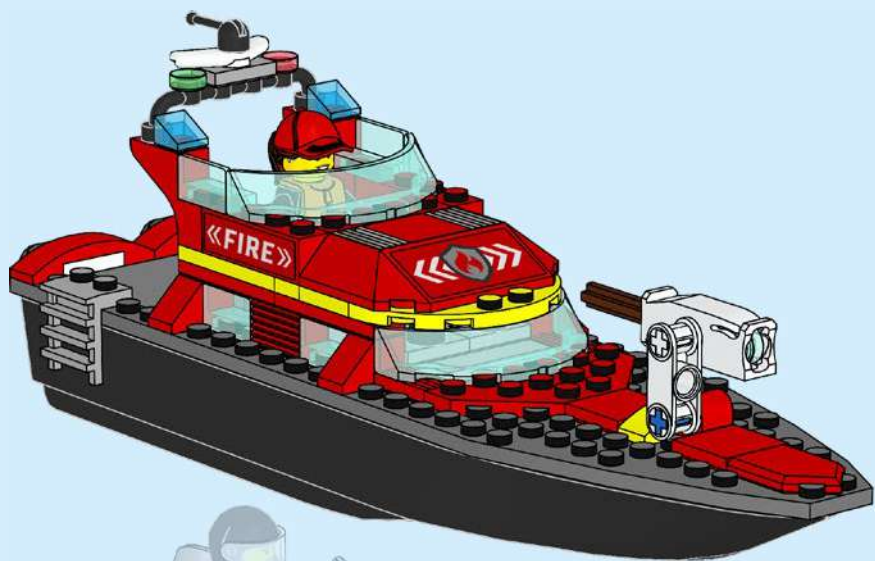



# CITY



60389



60387



60383



60384



60385



# CITY



1x  
4624086



1x  
4243824

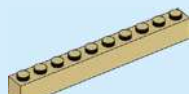

2x  
4166138

2x  
4558886

2x  
6219677

4x  
4121934

1x  
6099736

2x  
241221

1x  
6001806

4x  
306821

2x  
6056816

1x  
6294045

3x  
301021

2x  
4633914

4x  
6256923

1x  
241921

1x  
6427263

1x  
6252744

1x  
6070698

2x  
6117940

1x  
6211335

1x  
6276981

1x  
6427399

1x  
6427264

1x  
302001

3x  
300901

1x  
4226995

3x  
6231925

1x  
6244787

1x  
6274742

1x  
6311265

1x  
6123730

1x  
6283884

1x  
73587

1x  
4298619

2x  
6143335

1x  
300426

1x  
6151289

1x  
6254472

1x  
6332022

2x  
4515362

1x  
6415609

1x  
4566179

1x  
6408579

1x  
4206482

1x  
407923

1x  
9566

2x  
4566522

1x  
4566607

1x  
4586410

1x  
6182217

1x  
6047422

3x  
4619636

1x  
4632100

2x  
6167034

3x  
6382324

1x  
6378287

2x  
6380691

1x  
6421396

1x  
6391549

1x  
6274747

2x  
6167741

1x  
6171727

1x  
6223059

1x  
6135494

1x  
6258607

9x  
6274739

1x  
6248530

6x  
6246890

2x  
6246853

4x  
6245256

1x  
4210698

1x  
6221607

1x  
6117346

2x  
6361702

1x  
4218696

1x  
4211105

1x  
4263176

2x  
6310290

1x  
6421395

1x  
6421400

1x  
6079461

1x  
6108560

2x  
4515374

3x  
6066097

1x  
6117967

2x  
6285243

1x  
6061675



 [LEGO.com/service](https://www.LEGO.com/service)