

Bissell®

AIR220/AIR320

3001, 3002 SERIES



| | |
|----|----------------------------|
| EN | USER GUIDE |
| AR | دخستس مل ل ل ل |
| BG | РЪКОВОДСТВО ЗА ПОТРЕБИТЕЛЯ |
| BS | KORISNIČKOM PRIRUČNIKU |
| CZ | UŽIVATELSKÁ PŘÍRUČKA |
| DE | BENUTZERHANDBUCH |
| DK | BRUGERVEJLEDNING |
| EL | ΟΔΗΓΟ ΧΡΗΣΗΣ |
| ES | GUÍA DEL USUARIO |
| ET | JUHENDIS |
| FI | KÄYTTÖOPAS |
| FR | MANUEL DE L'UTILISATEUR |
| HR | KORISNIČKI VODIČ |
| HU | HASZNÁLATI ÚTMUTATÓ |
| IT | GUIDA PER L'UTENTE |
| LT | NAUDOTOJO VADOVE |
| LV | LIETOTĀJA ROKASGRĀMATĀ |
| MK | УПАТСТВО ЗА УПОТРЕБА |
| NL | GEbruIKERSHANDLEIDING |
| NO | BRUKERVEILEDNING |
| PL | INSTRUKCJA OBSŁUGI |
| PT | MANUAL DE UTILIZAÇÃO |
| RO | GHID DE UTILIZARE |
| RU | РУКОВОДСТВО ПОЛЬЗОВАТЕЛЯ |
| SE | ANVÄNDARHANDBOK |
| SK | POUŽIVATEĽSKÁ PŘÍRUČKA |
| SL | UPORABNIŠKEM PRIROČNIKU |
| SR | KORISNIČKOM UPUTSTVU |
| TR | KULLANICI KILAVUZU |

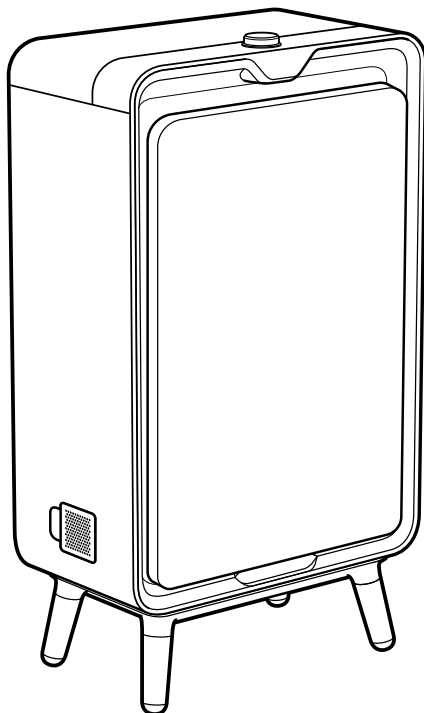



.....3



.....4

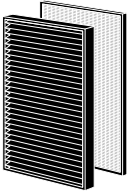

.....5



.....7

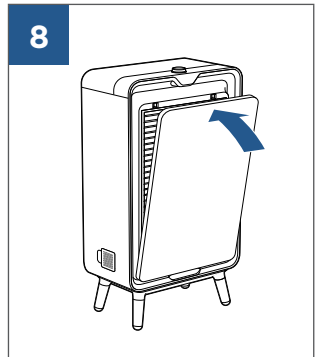
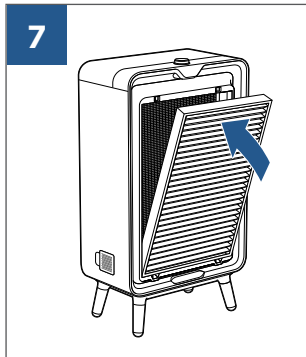
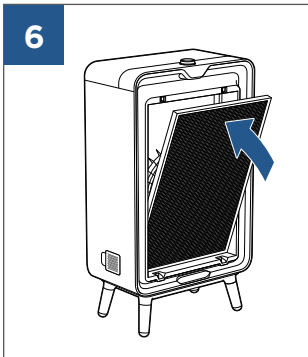
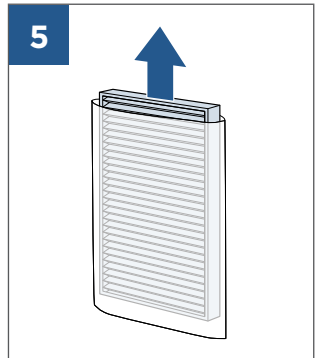
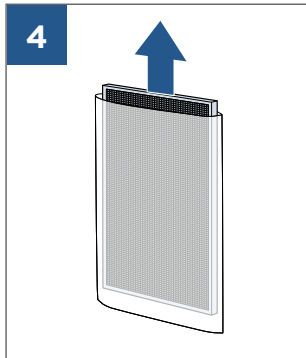
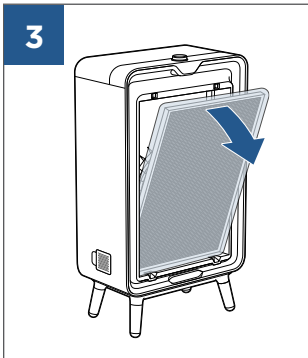
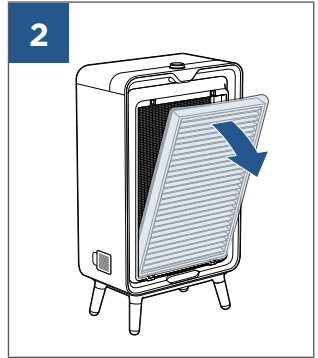
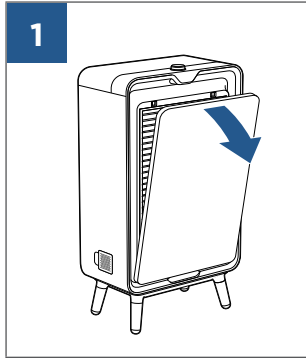

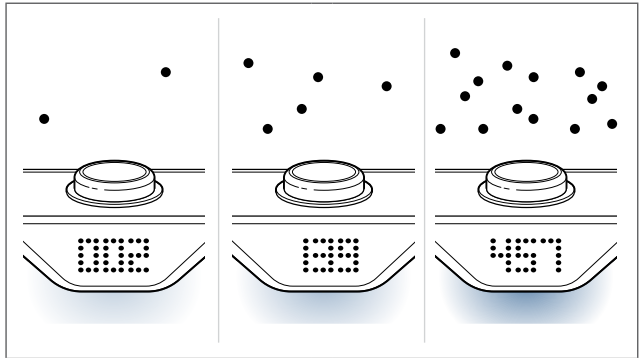
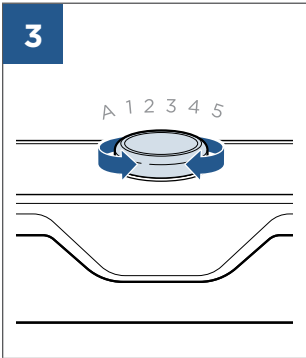
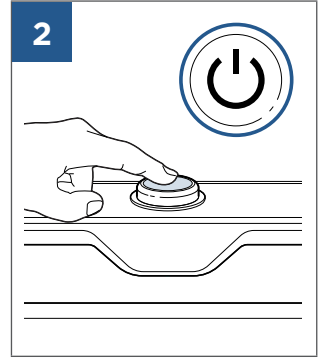
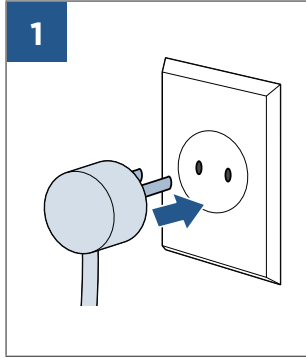
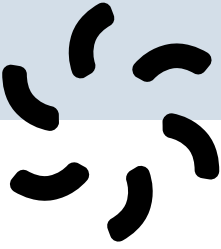

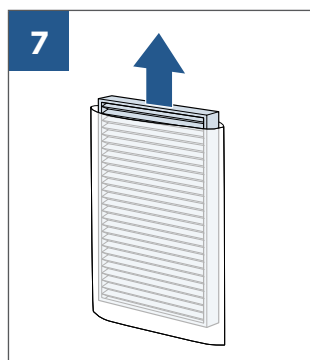
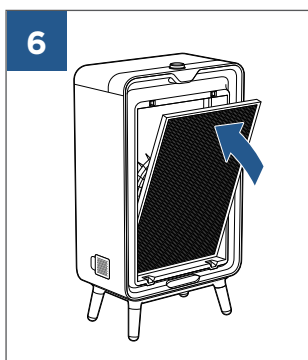
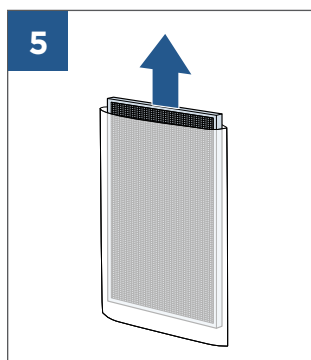
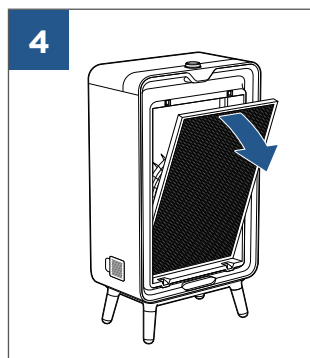
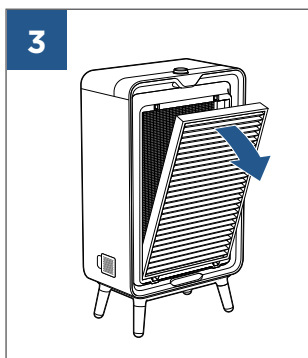
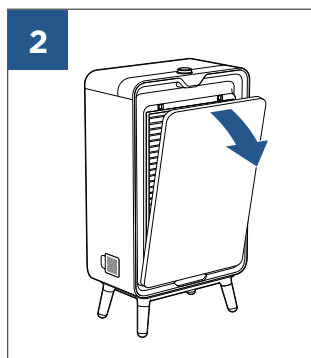
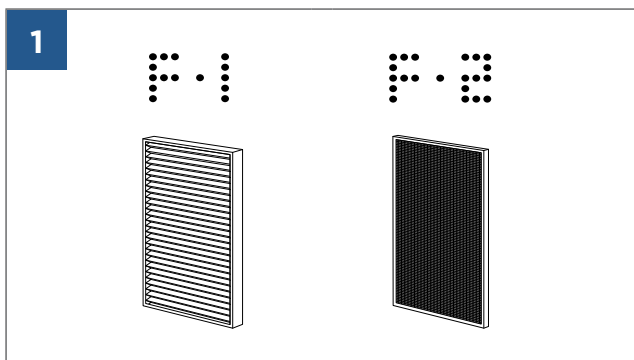
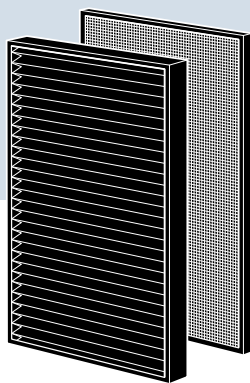

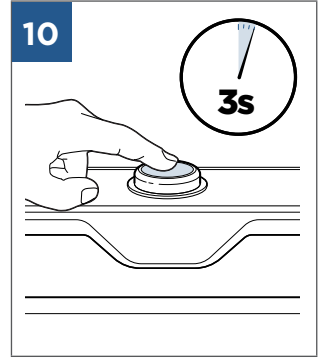
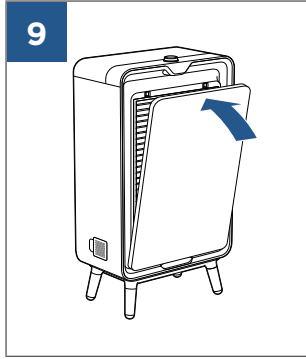
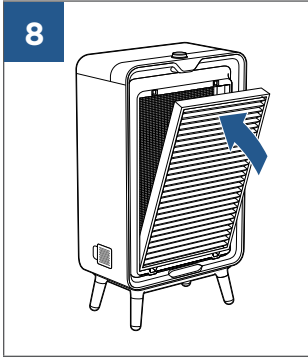

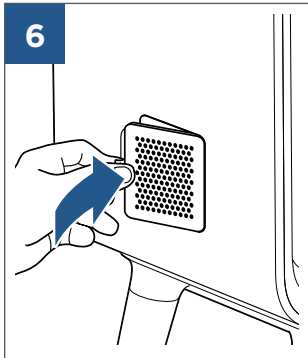
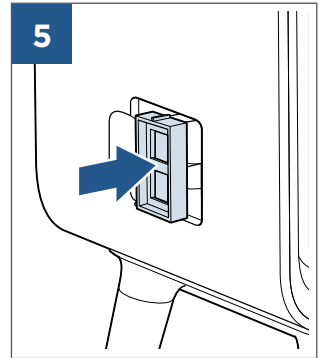
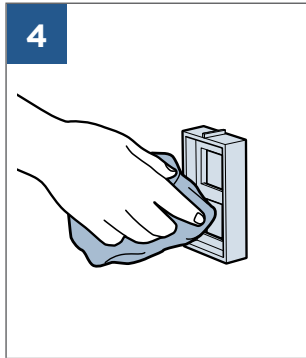
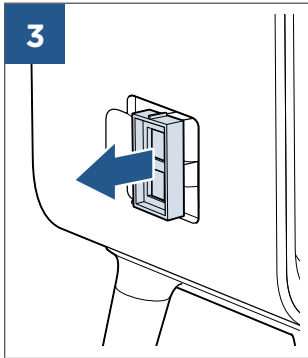
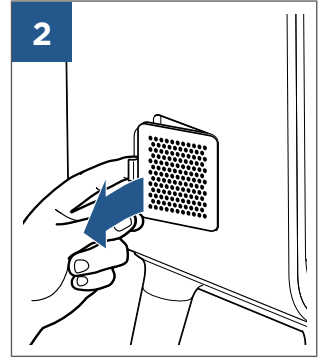
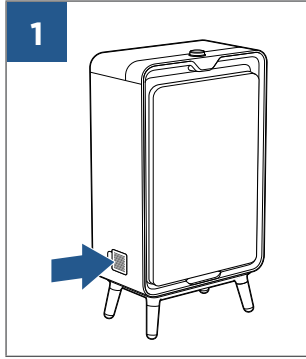



©2021 BISSELL Inc. All rights reserved.
Part Number 1624506 01/21 Rev B