

VIDEO COMPUTER SYSTEM

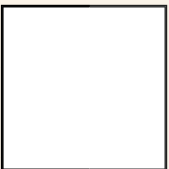

Booklet available in English on
Heft in deutscher Sprache erhältlich auf
Livret disponible en français sur
Libretto disponibile in italiano su
Folleto disponible en español en
如需中文版手册, 请访问



HAVE YOU BUILT ATARI® TODAY?

Unveiled in 1977, the ATARI® Video Computer System brought the realistic thrills of the arcade into the home and would go on to become one of the most popular gaming systems in history with 30 million units sold. This LEGO® version of the ATARI® Video Computer System is the iconic four-switch CX-2600A from 1980. It's full of authentic details and hidden gems that will take you back in time to the halcyon days of classic gaming. Enjoy.

THE GAMING ICON

As incredible as it sounds, the four-switch CX-2600A – the most popular version of the ATARI® Video Computer System – celebrates its 42nd anniversary in 2022. It set the standard for console gaming in its day and remains the starting point for all retro console design from ATARI® today.





HAVE YOU PLAYED ATARI TODAY ?

ATARI 50



50 YEARS OF FUN

Founded in 1972 ATARI® remains one of the most iconic names in the gaming world, and more than half a century later the brand continues to resonate with fans and those looking for the thrill of vintage gaming. Namechecked widely in countless TV shows, movies and in pop culture, ATARI® has also become an authentic cultural reference point reaching far beyond its computer gaming origins.



← The cartridge system allowed players to immerse themselves in many different games

↓ Advertisement for the ATARI® Video Computer System

ATARI

**THERE'S NO
COMPARING IT WITH ANY
OTHER VIDEO GAME.**

Only Atari makes the games the world wants most.
Games that are innovative, intense, incredibly involving,
and totally original.

The most games, the best games all only from ATARI.
Atari makes more video game cartridges than anyone else.
Today ATARI's Missile Command and Asteroids are the
fastest selling home video games in the country.





MORE GAMES. MORE FUN.

Unlike many earlier gaming systems that only offered a single integrated game, ATARI® used a cartridge system that allowed a virtually limitless selection of games. A total of 527 games would be published for the ATARI® Video Computer System and hits such as *Asteroids*, *Ms. Pac-Man*, and *Pitfall* established it as the must-have gaming system in the late '70s and early '80s.



1980

ADVENTURE

In a game that would inspire a whole generation of quest adventures, the wicked wizard has stolen your castle's magical chalice and you must lead your brave knight through terrible dangers to ensure its safe return!



1981

ASTEROIDS

The highly addictive object of this game is to gain the highest score by shooting down waves of asteroids, satellites and UFOs. Once shot, the asteroids break into smaller, faster pieces that fly off in unpredictable directions!



1982

CENTIPEDE

Use the wand at the bottom of the screen to destroy as many bugs as you can. Your nemesis is a long and winding centipede that invades each level. To proceed in the game, you must exterminate each segment of the centipede in every level!

BUILDING AN ICON

This 2,532-piece LEGO® model is a close 1:1 representation of the iconic four-switch ATARI® Video Computer System (Model CX-2600A). As well as a replica joystick that plugs into the back of the console, it also has four functioning switches on the front.

Three cartridges of famous VCS games are included, and each game is represented by a buildable LEGO vignette visualising the gaming experience offered. All the games can be stored in a cool '80s-style cartridge holder when not in use!



FRONT PANEL



BACK PANEL

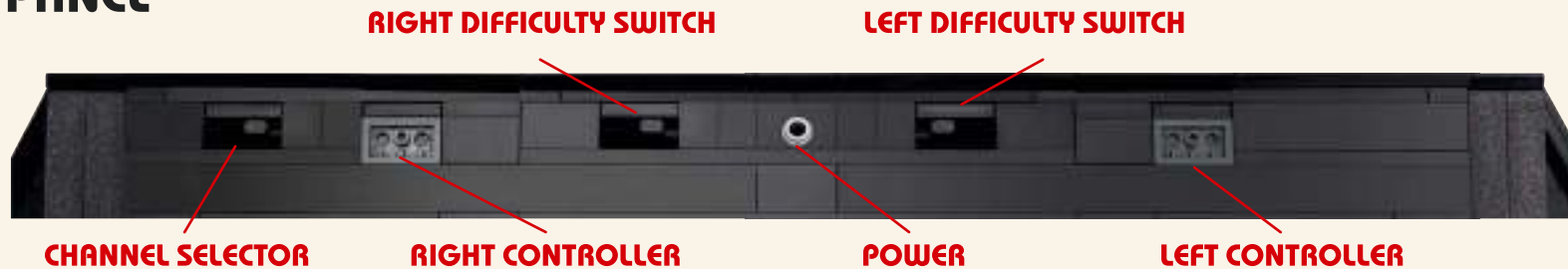

THE ATARI® VIDEO COMPUTER SYSTEM

There were various versions of the ATARI® Video Computer System launched between 1977 and 1992, mostly differentiated by weight, number of switches or the finish of the console itself. The technology, while impressive

in its day seems inconceivable today, with a limited processor speed of 1.19 MHz, a total capacity of 128 bytes of onboard RAM and a game cartridge capacity of only 4 kilobytes!

FROM THE DESIGN TEAM

As an avid fan of classic console gaming and a proud owner of an original ATARI® Video Computer System, working on this project in time for ATARI's 50th anniversary was a dream come true! Once we decided on the overall scale and features of the model, it was all about getting the little details just right: designing switches that can be toggled up and down, building a joystick that both looks and

feels like the original and creating a brick-built version of the classic woodgrain for the front of the console. Of course, we couldn't recreate the actual games themselves, but we decided to include three buildable vignettes to bring fans closer to the gameplay experience of these classic games.

LEGO® Designer, Chris McVeigh



The hidden pop-up scene is full of details that will feel instantly recognisable to anyone who grew up playing video games in the '80s



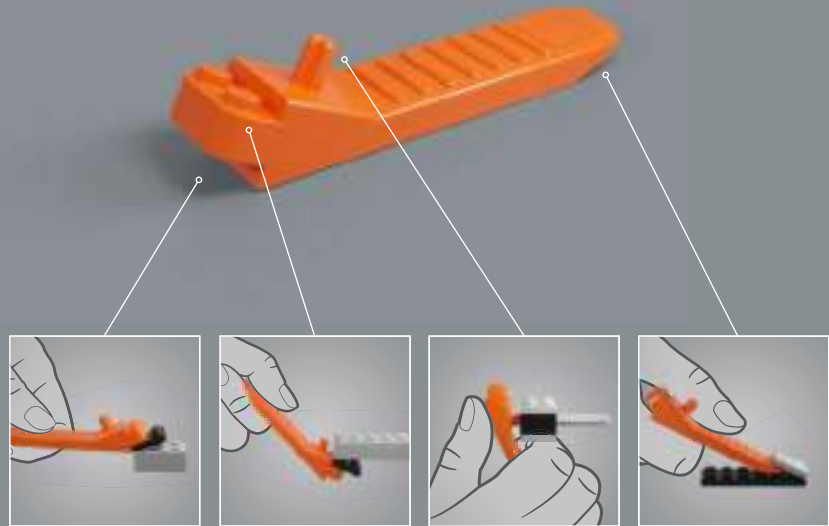

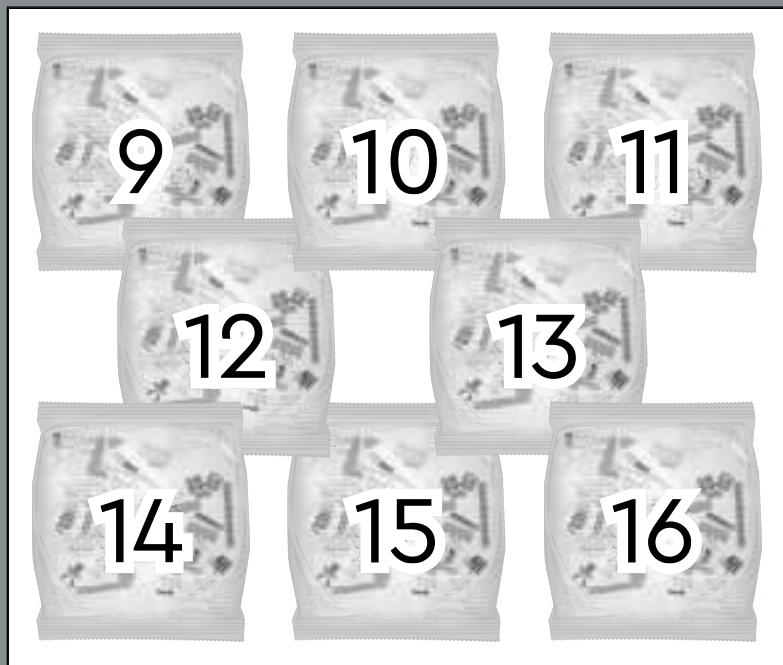
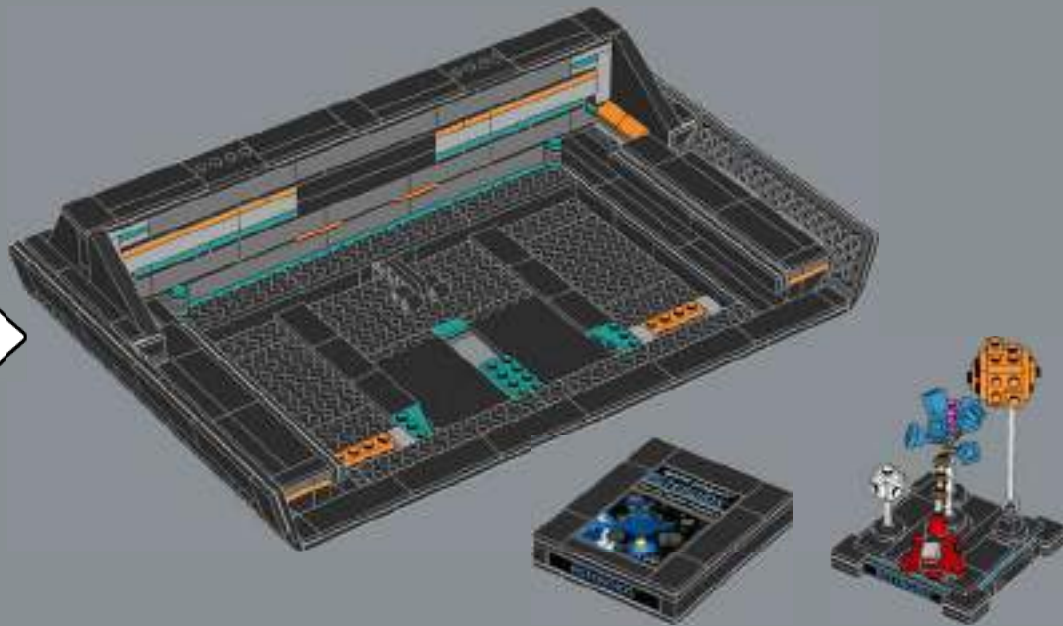

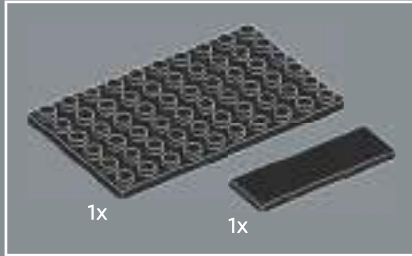

1

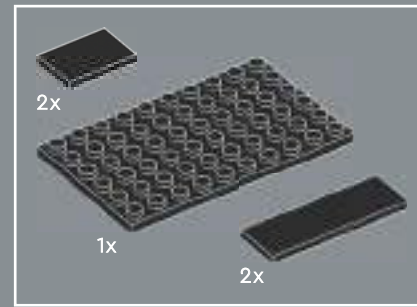
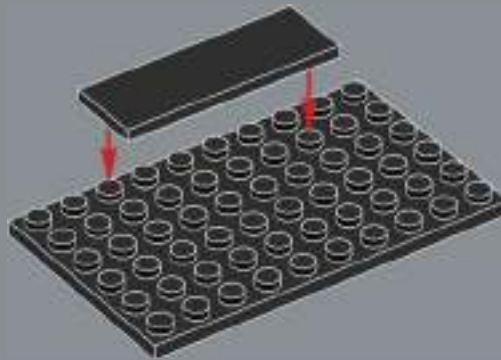

2

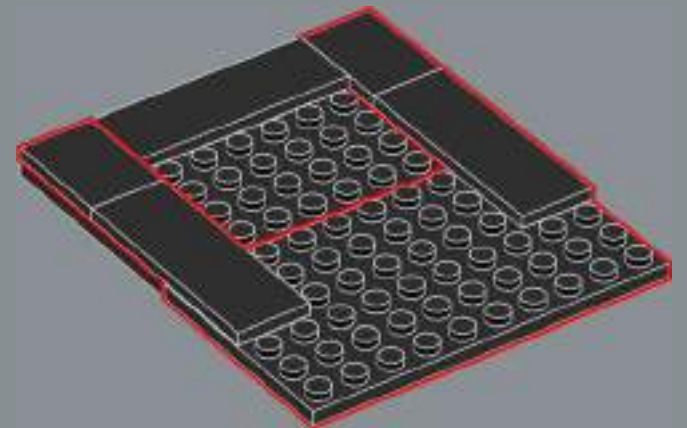

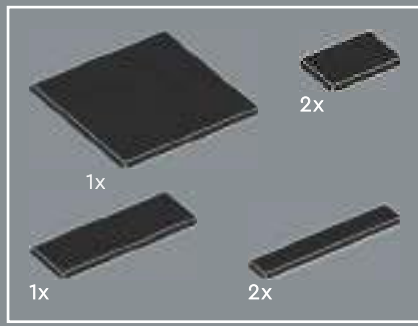

3

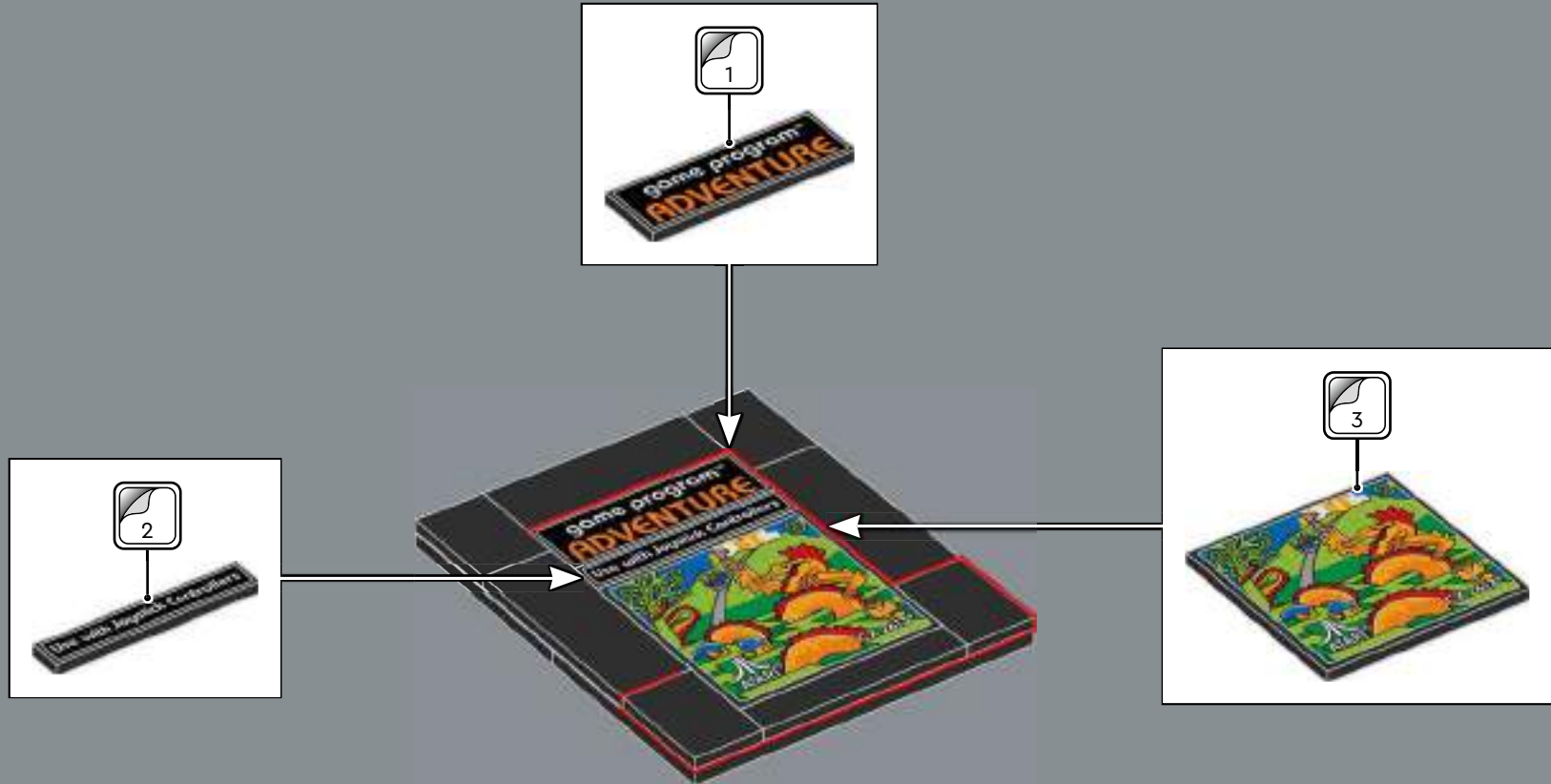

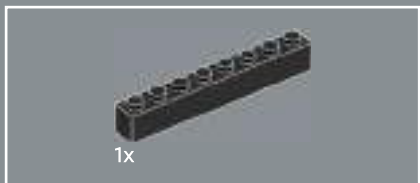

4

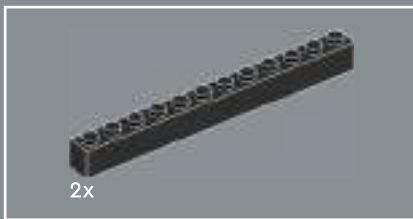

5

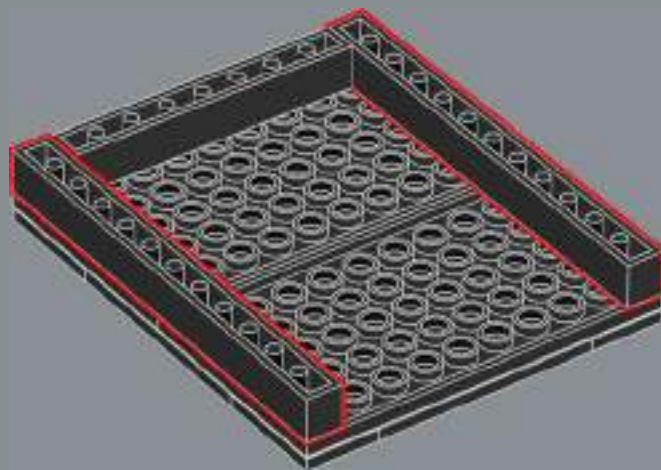



6

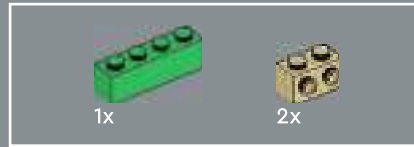
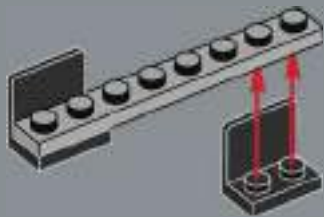

7

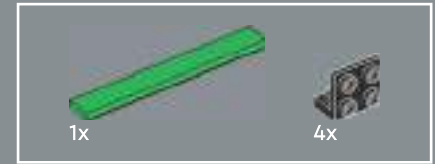
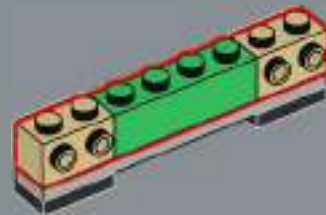

8

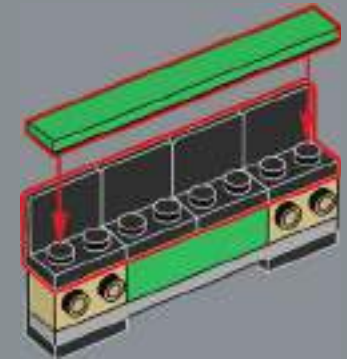

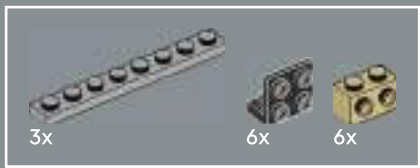

9

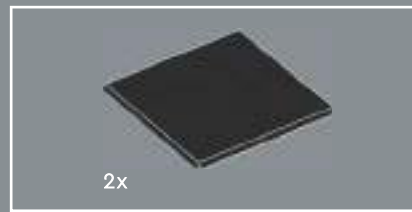
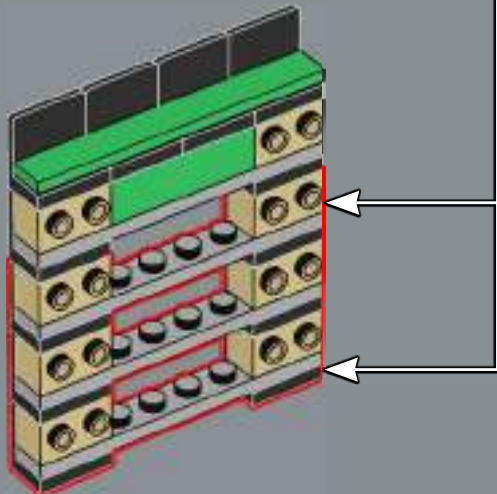
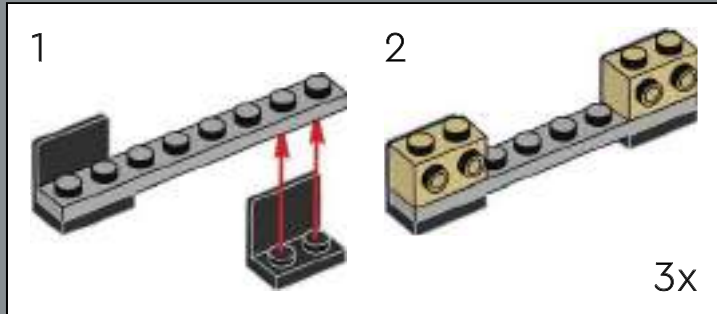

10

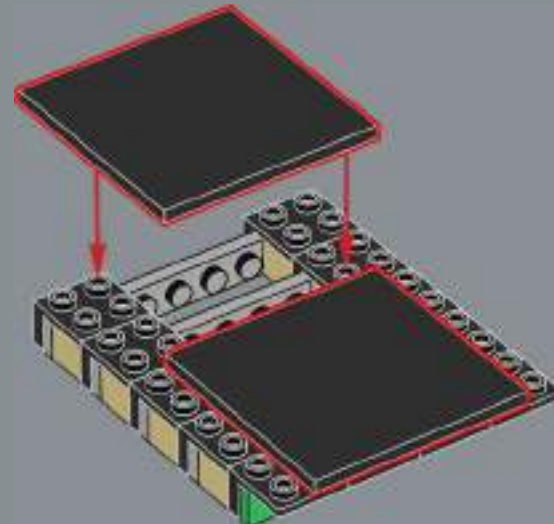

Many of the first ATARI® Video Computer System game cartridges used just 2k of data. That's roughly equivalent to a single page of text.



11

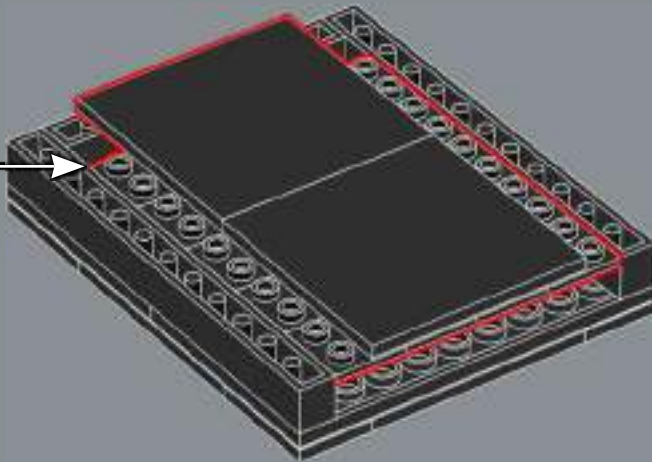

12

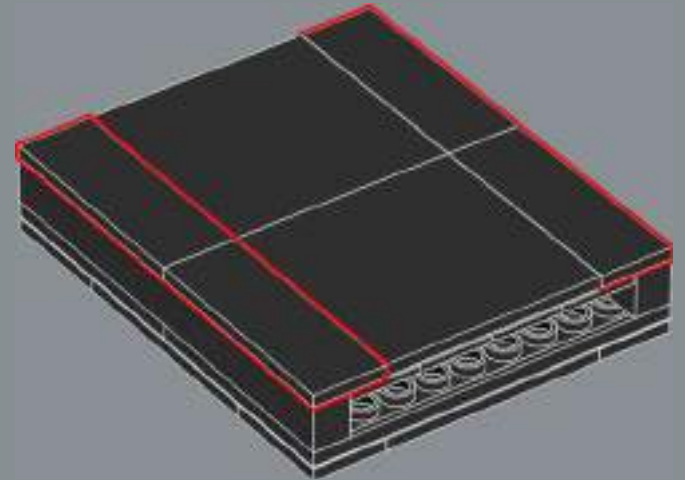
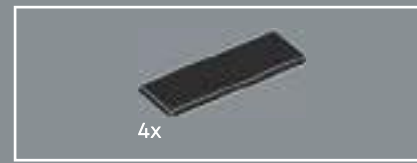

13





4

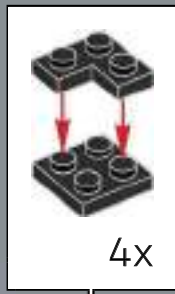
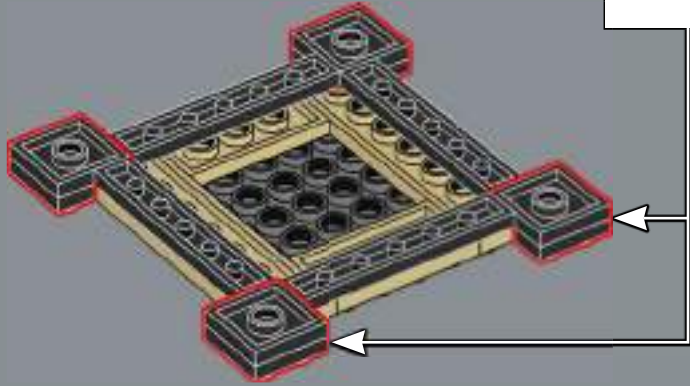

5

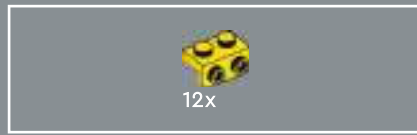
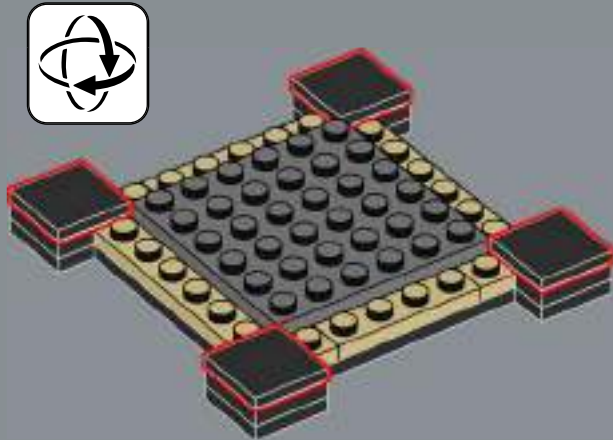

6

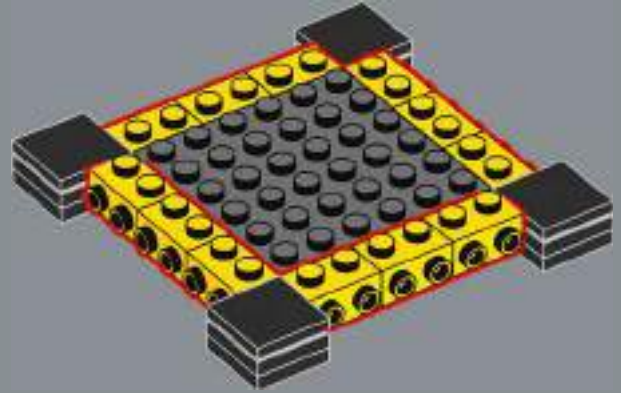

7

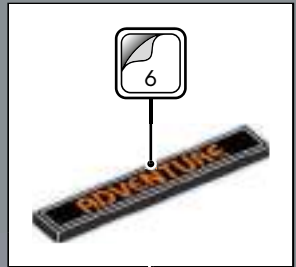

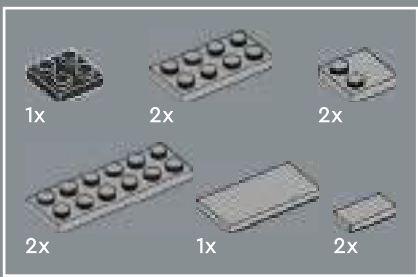

8



9

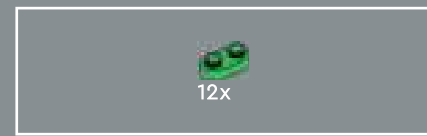

10

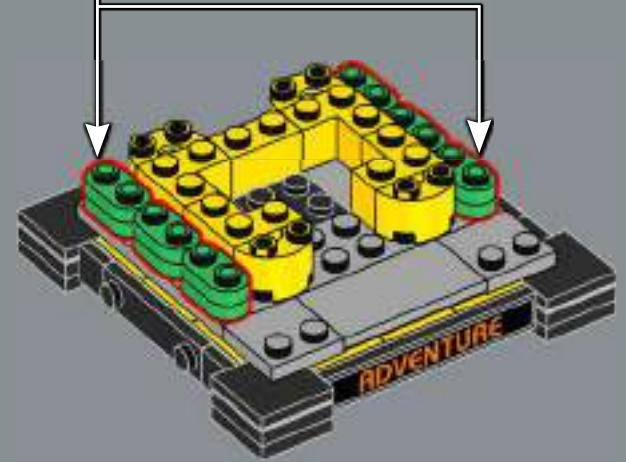



11

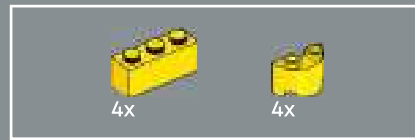
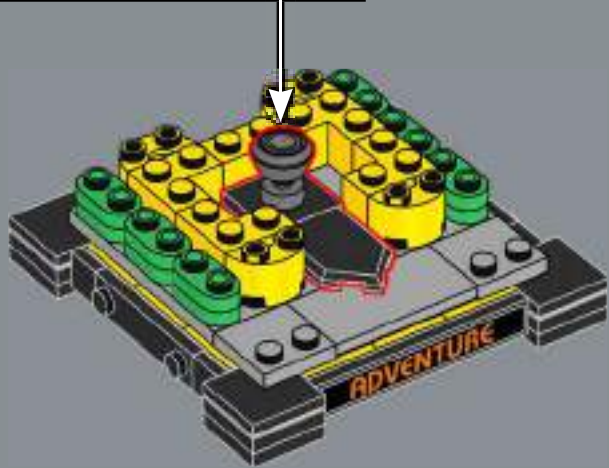

12

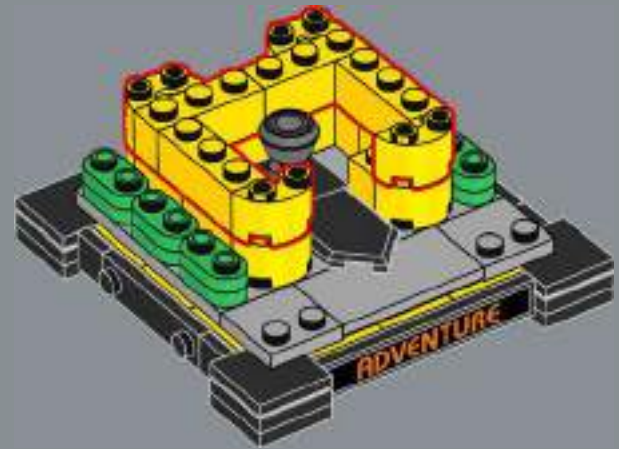

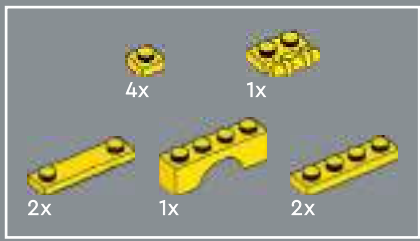

13

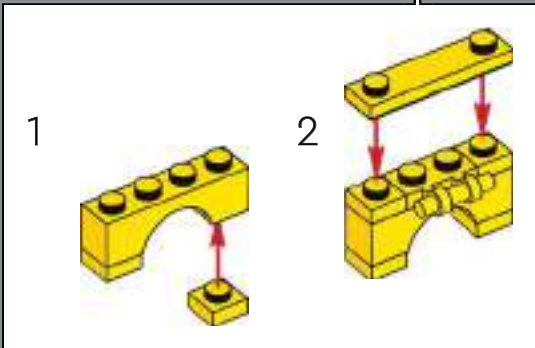
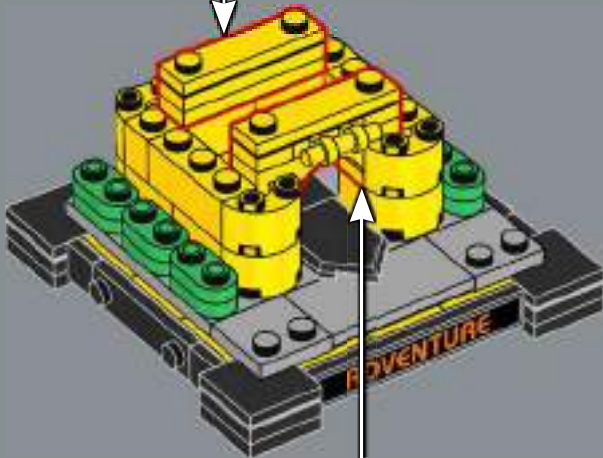
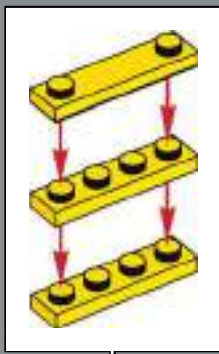

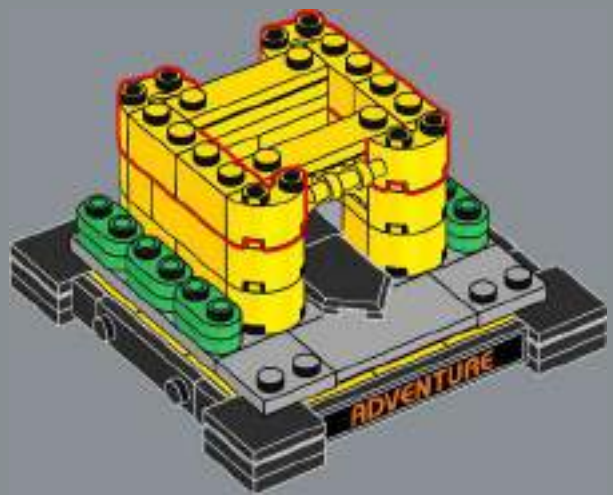

14

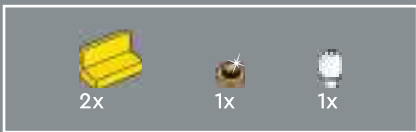

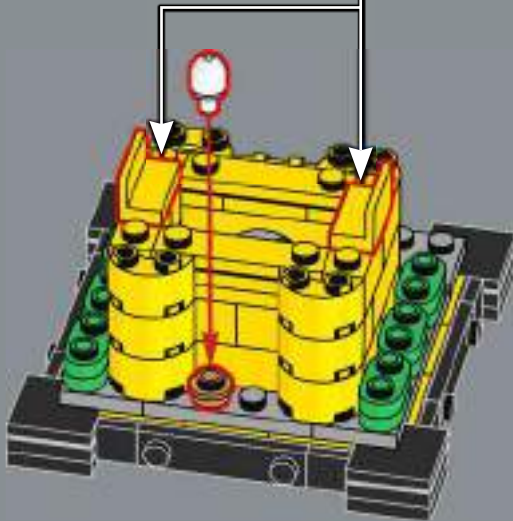
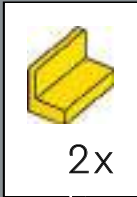

15



The Adventure vignette includes a small nest with egg at the back of the castle. This is a nod to the fact that Adventure features the first-ever Easter egg in a video game. 



16

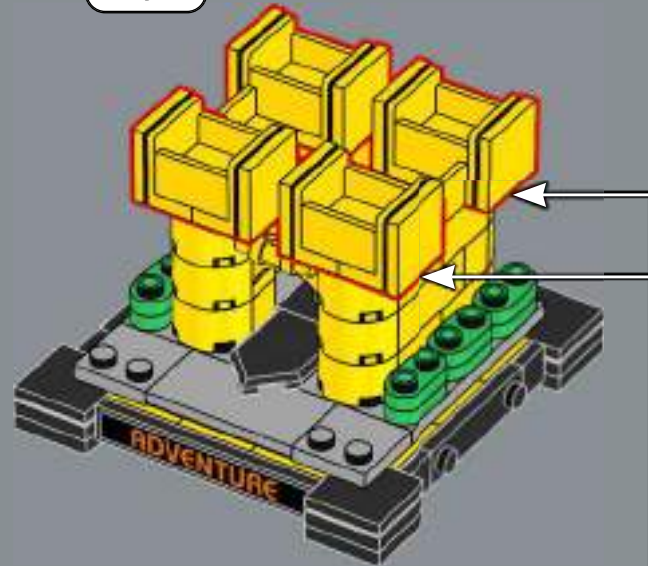



17



18

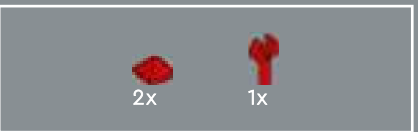

19



20



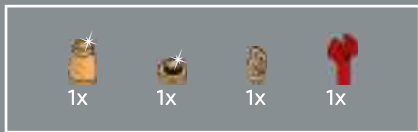

21

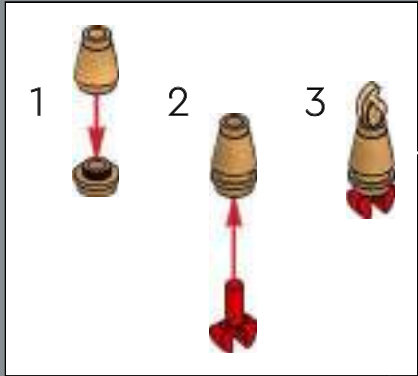

22

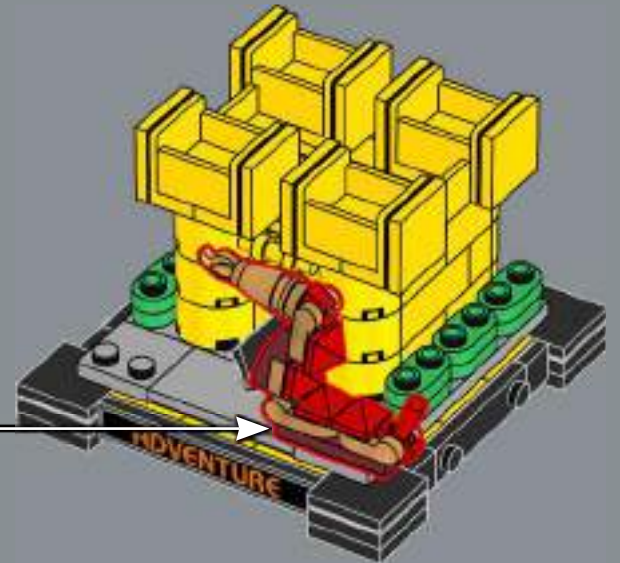



3

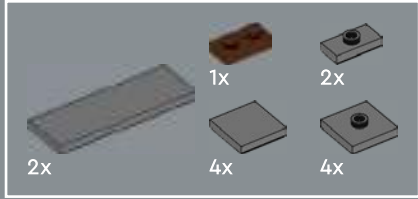
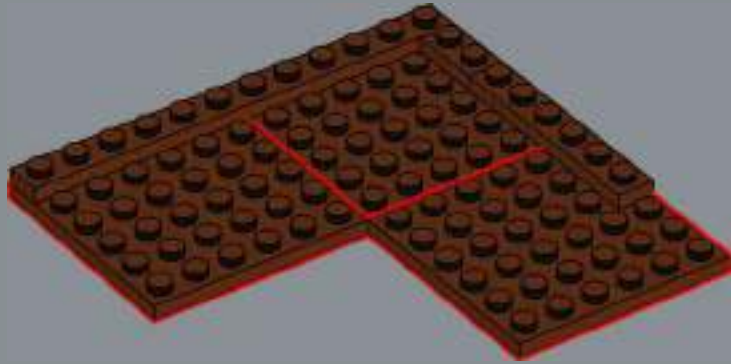

4

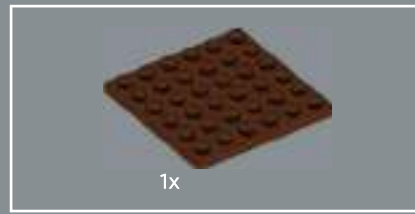
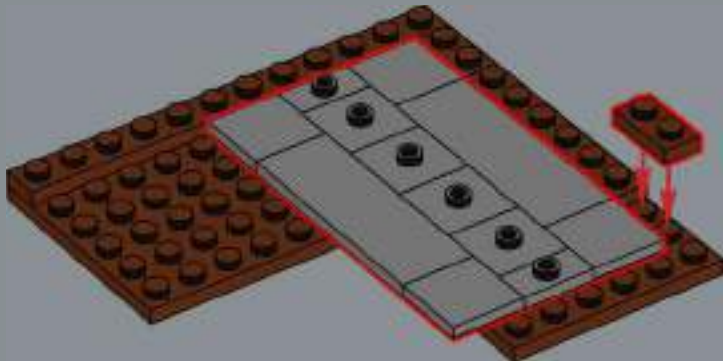

5

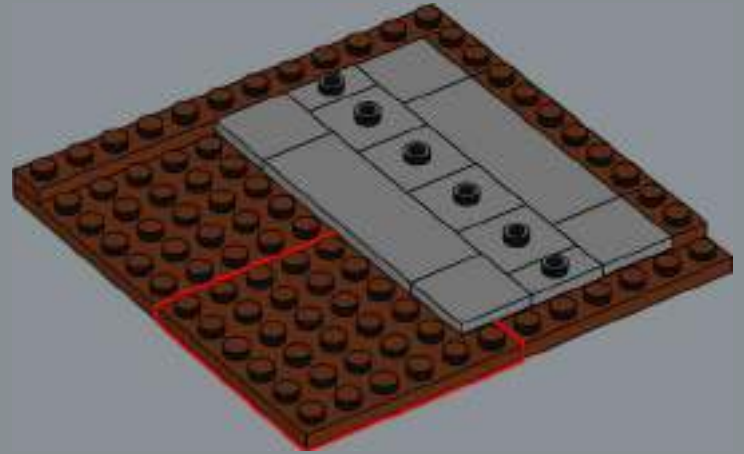

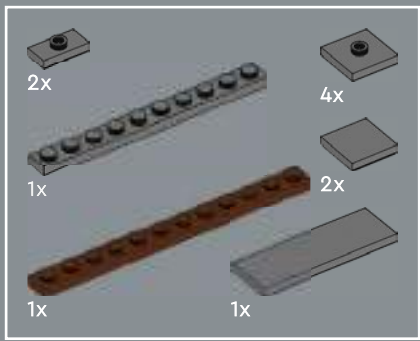

6

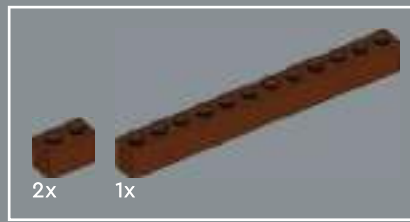
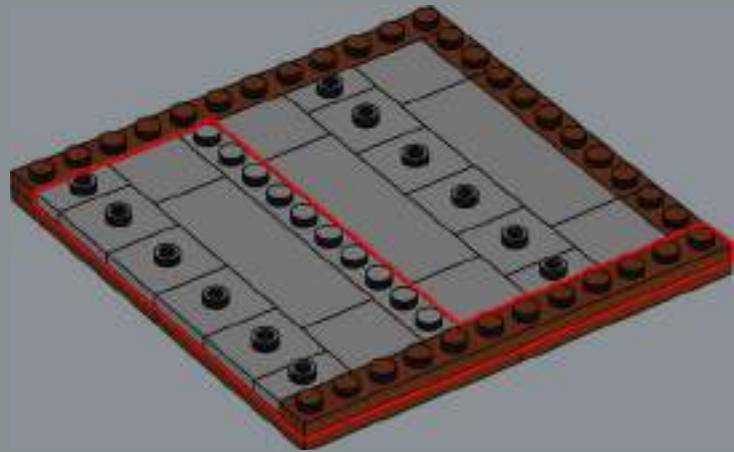

7

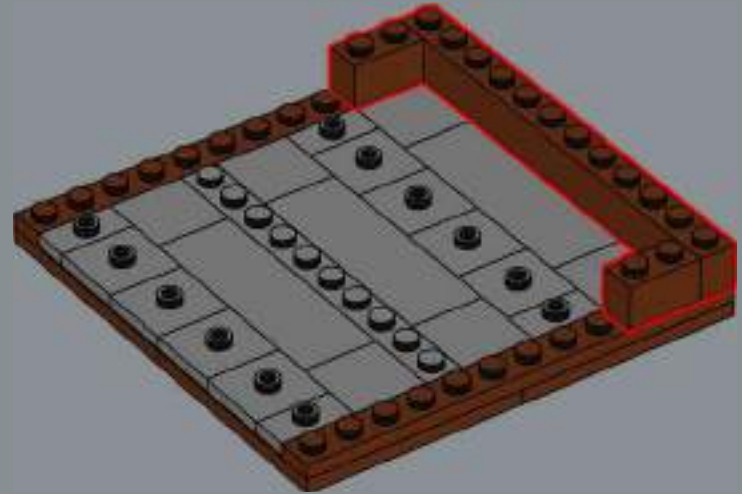



8

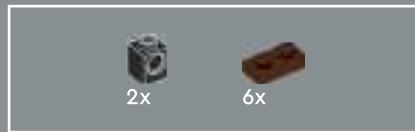
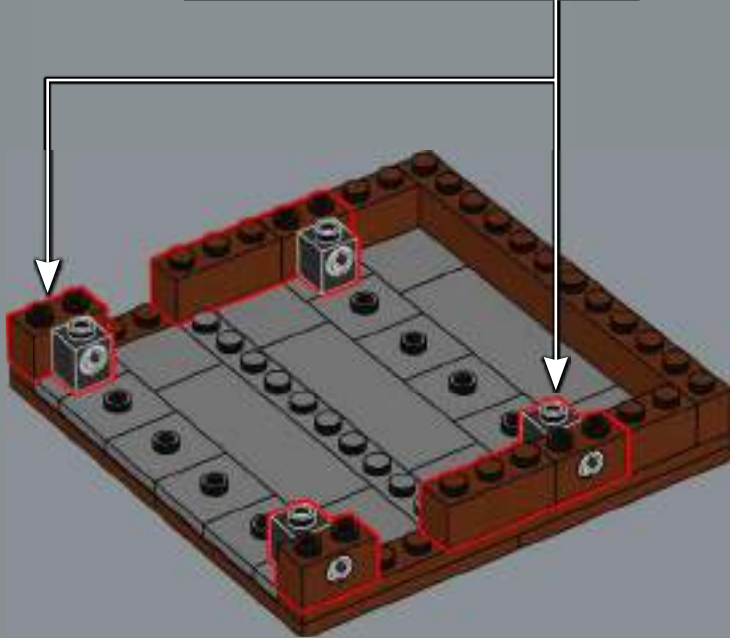
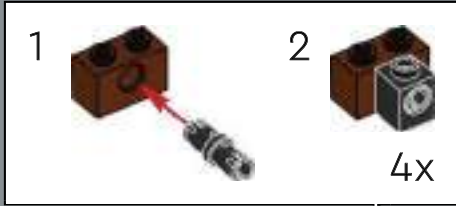

9

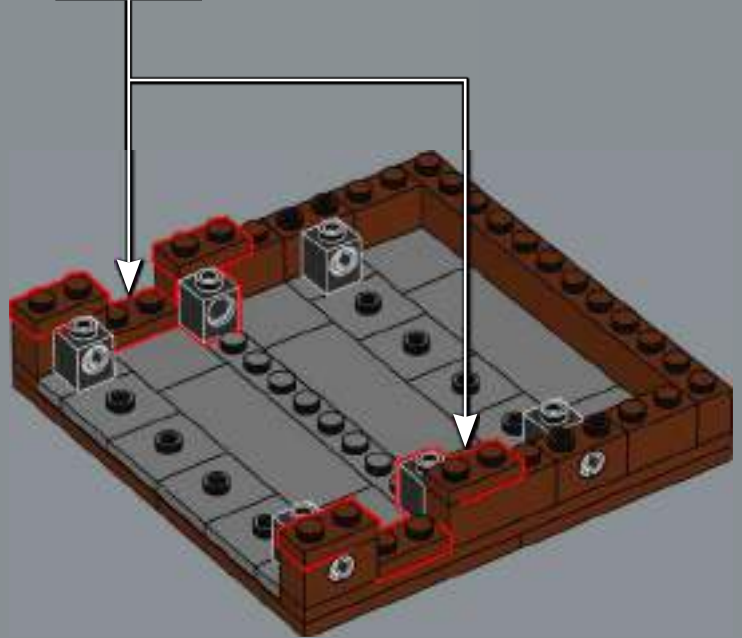

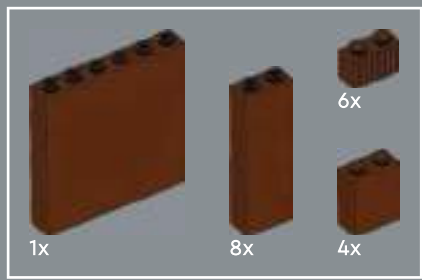

10

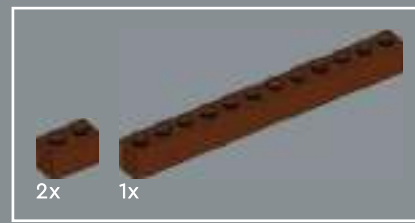
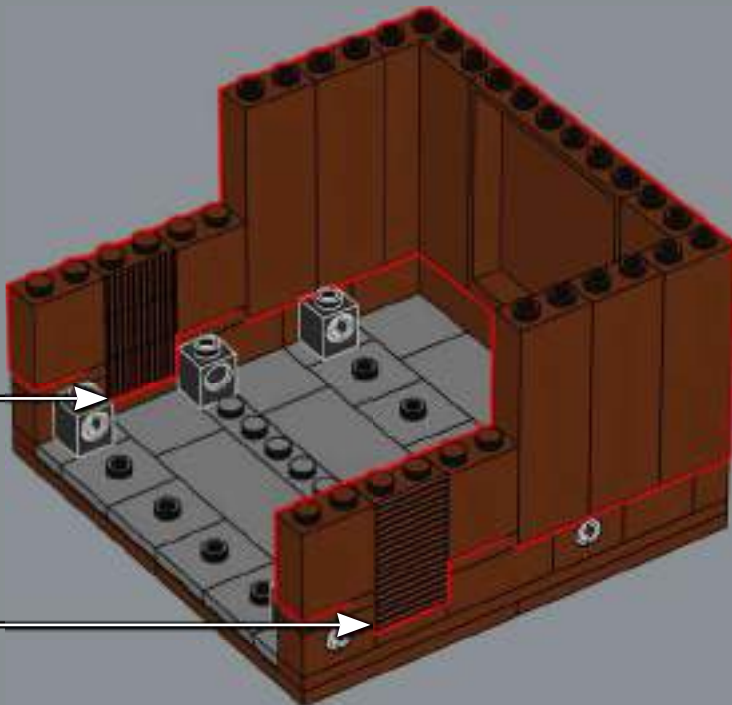
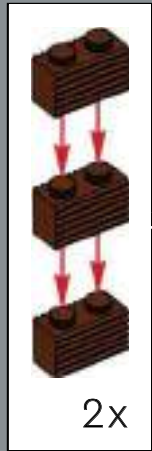

11

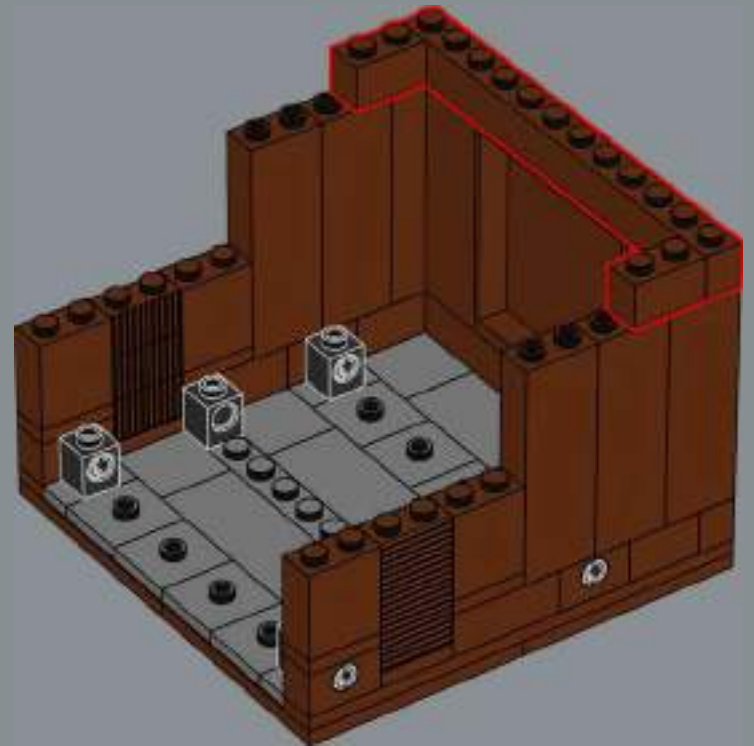

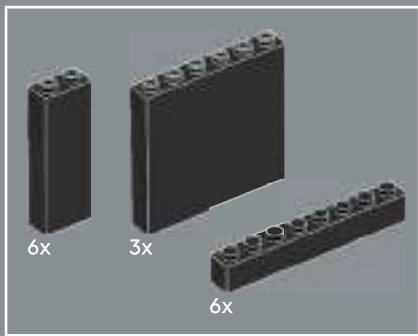

12

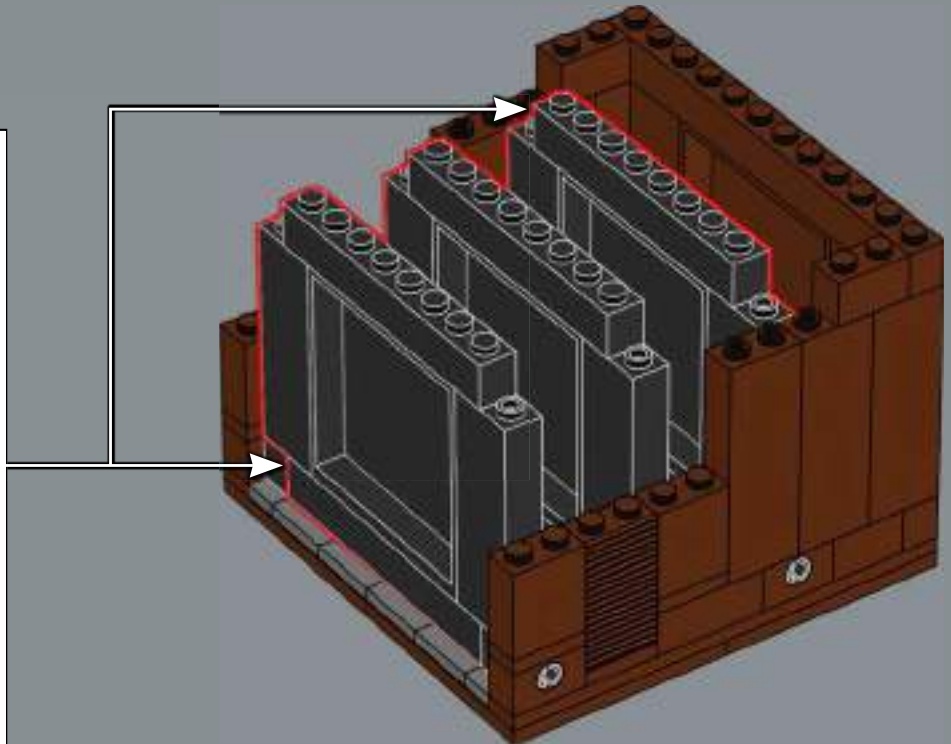
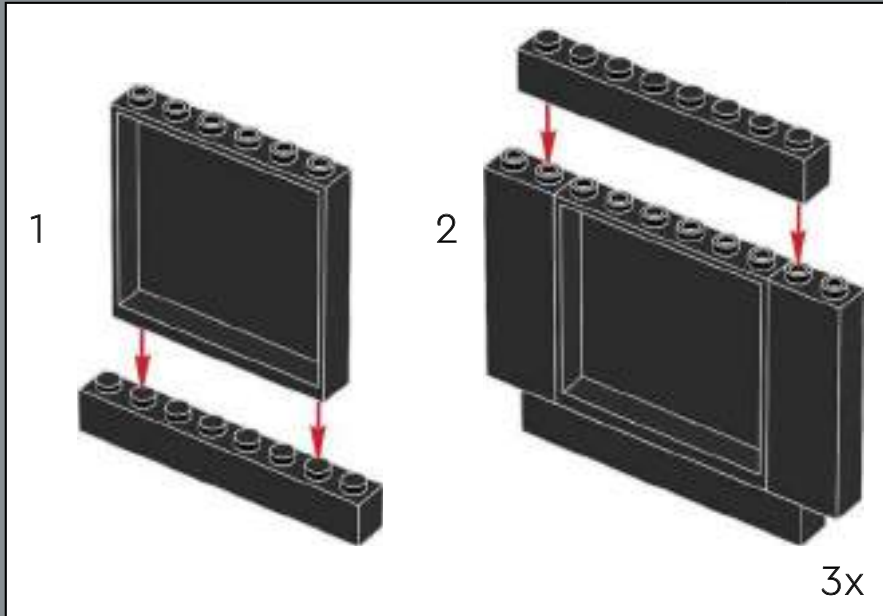

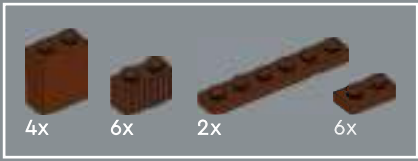

13

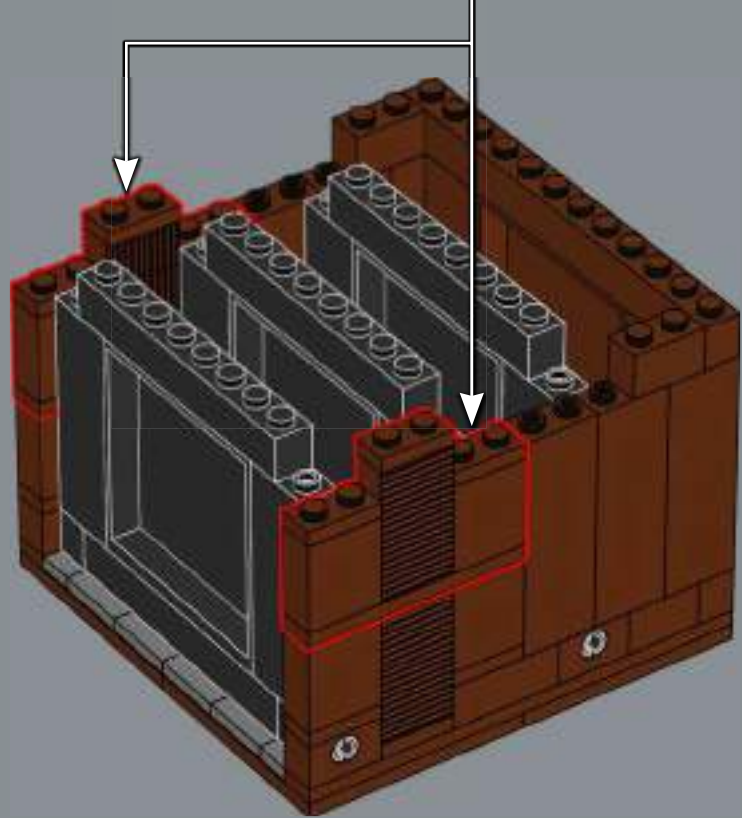
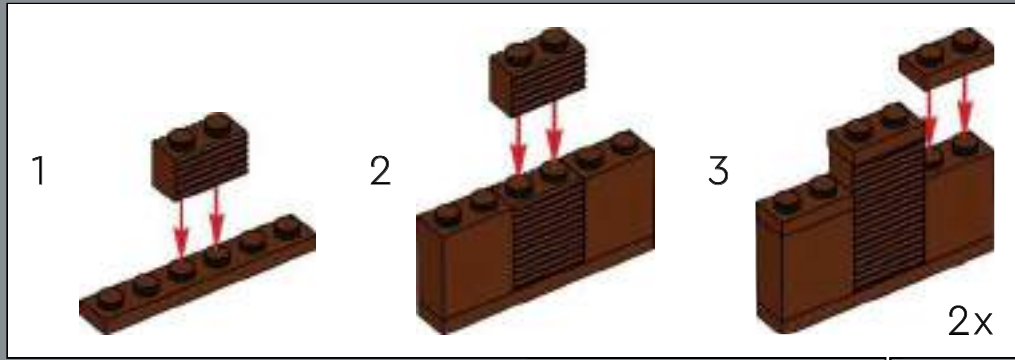

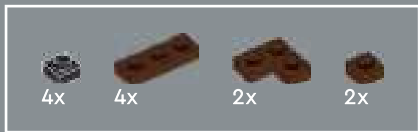

14

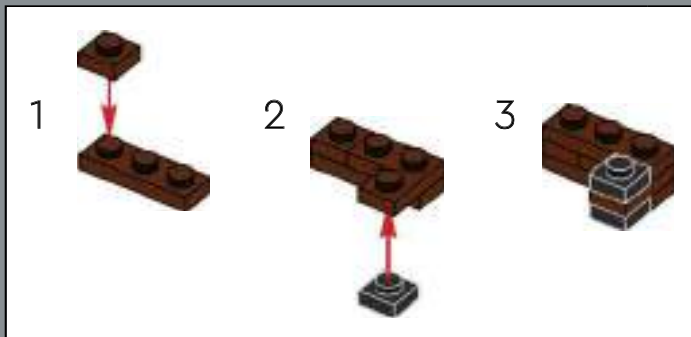
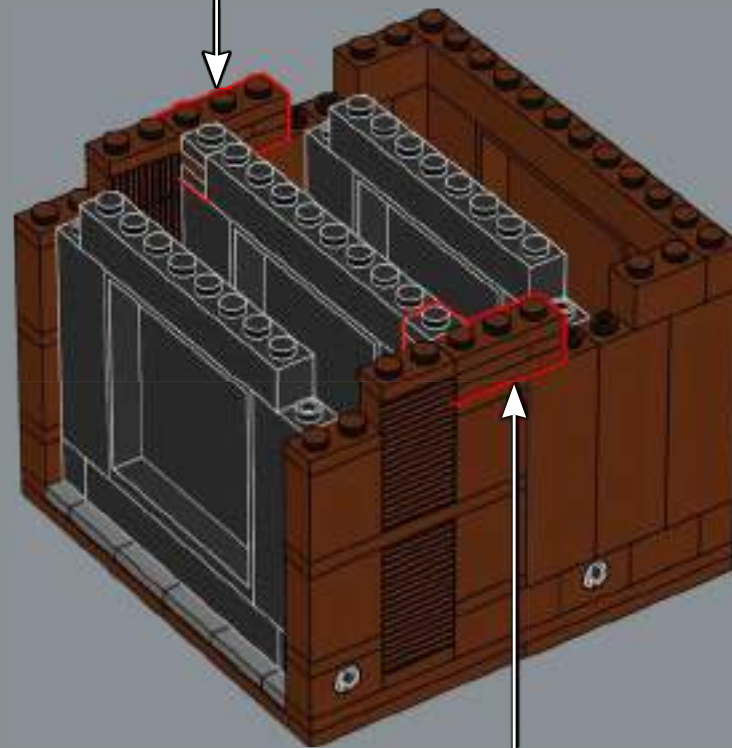
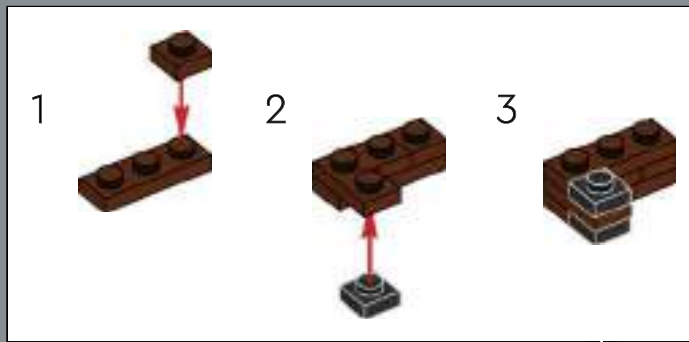



15

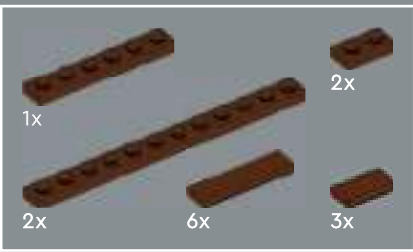
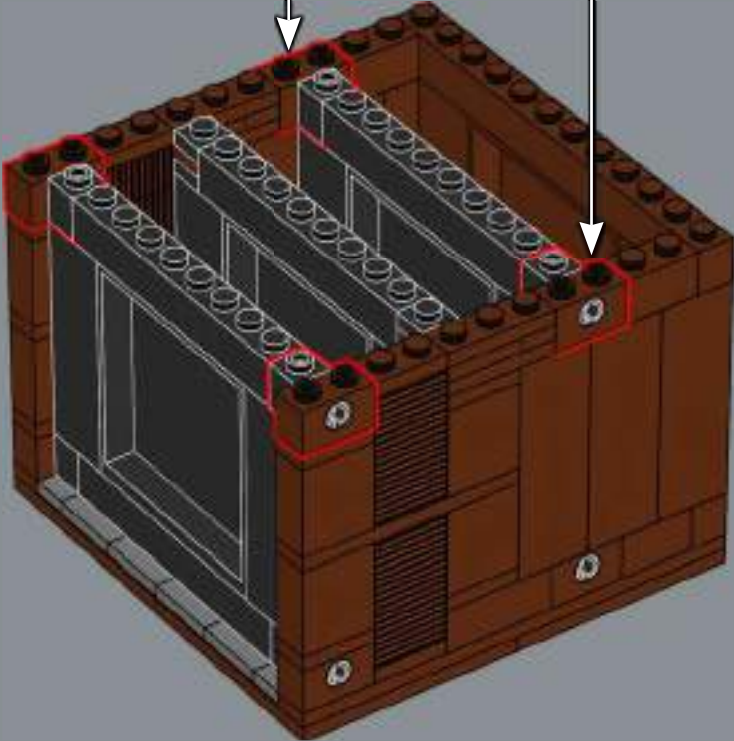
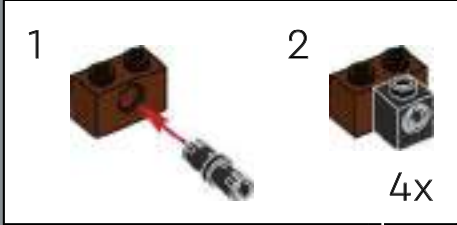

16

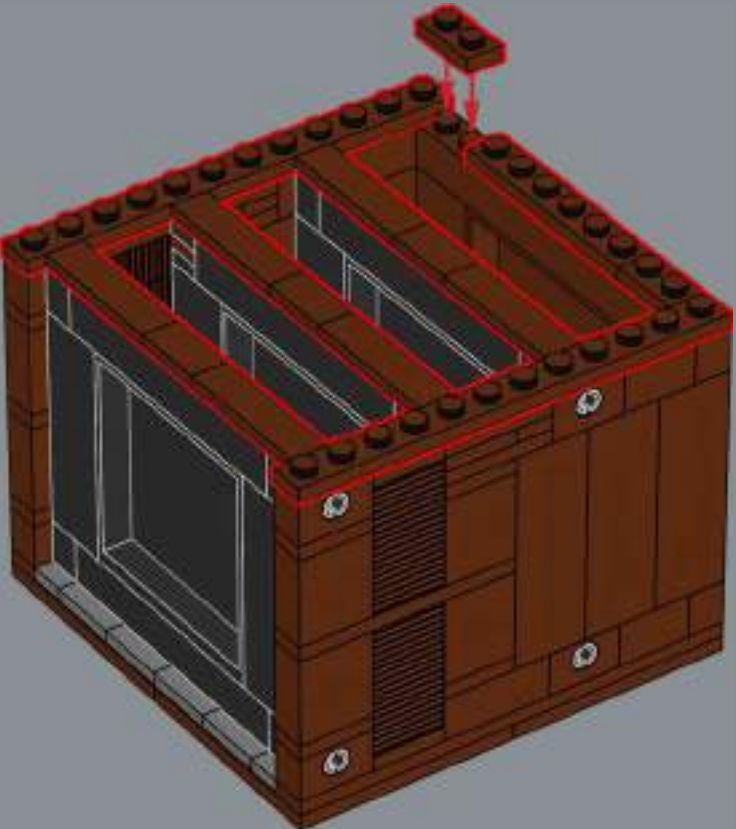



17

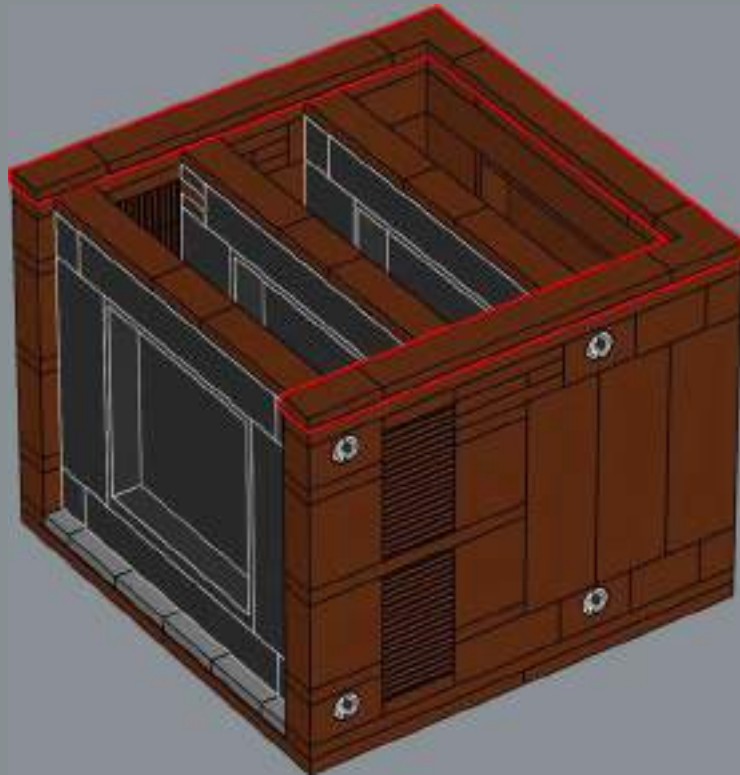

18



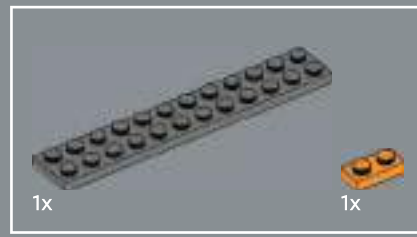
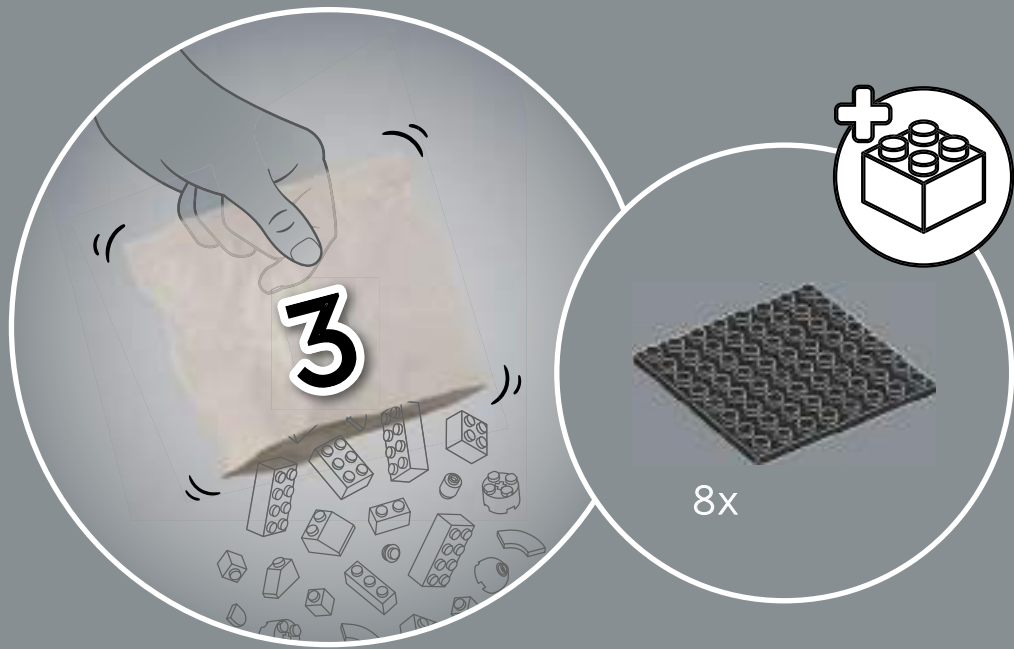

1

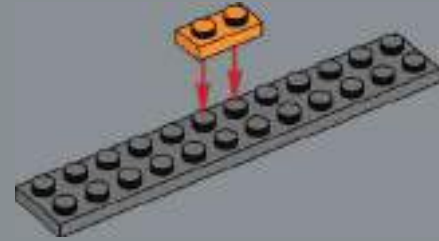

2

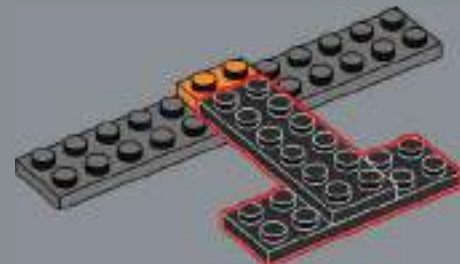

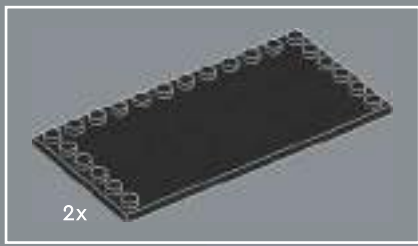

3

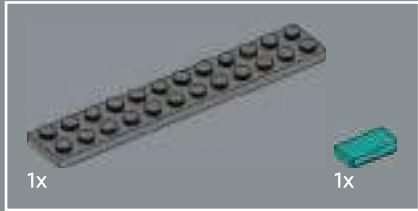
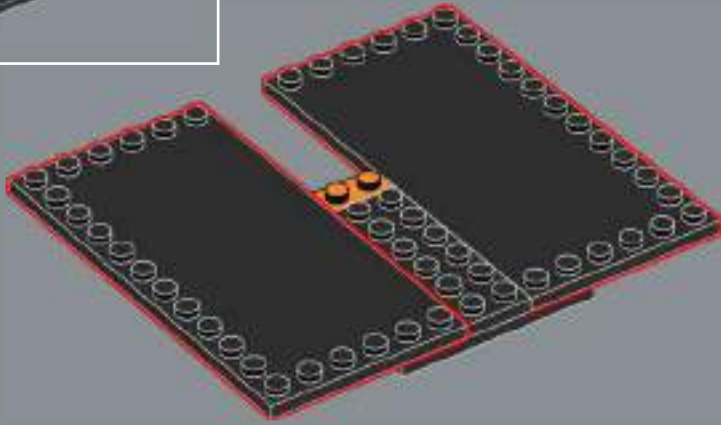

4

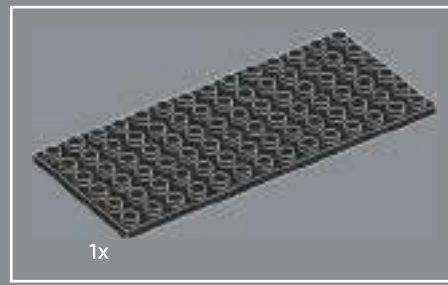
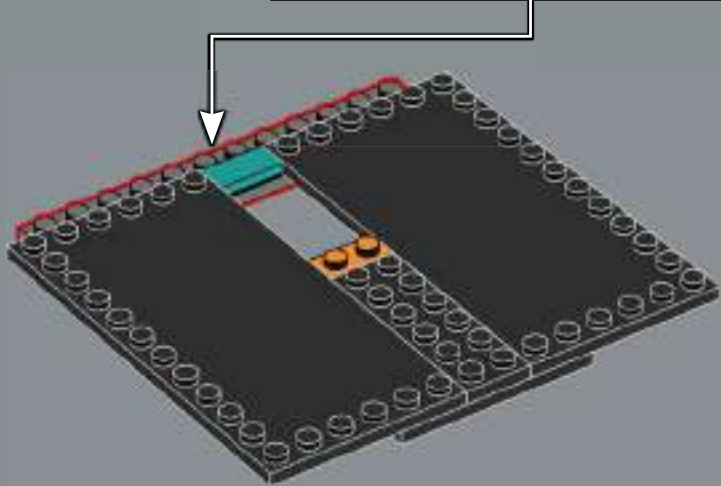
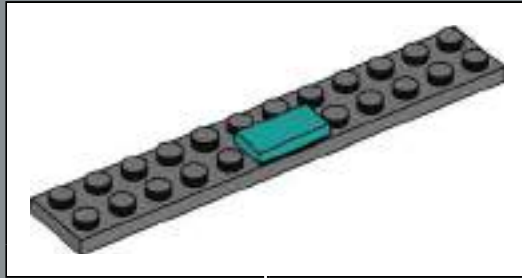

5

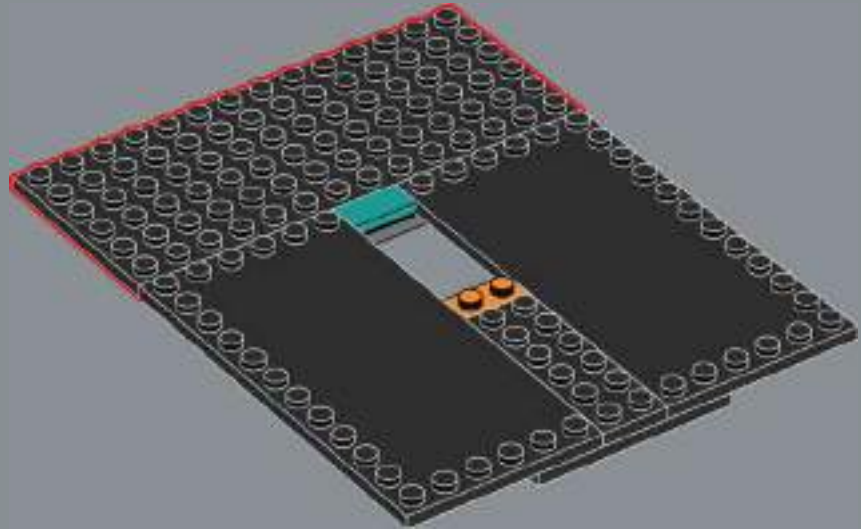

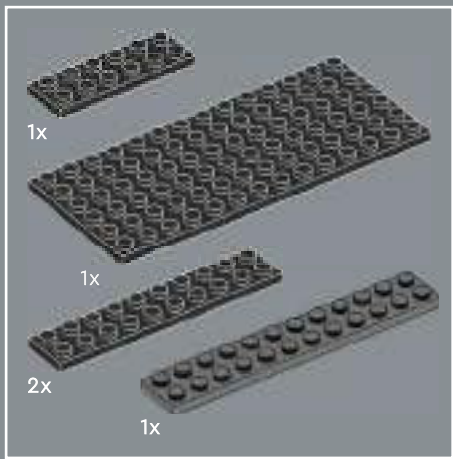

6

1

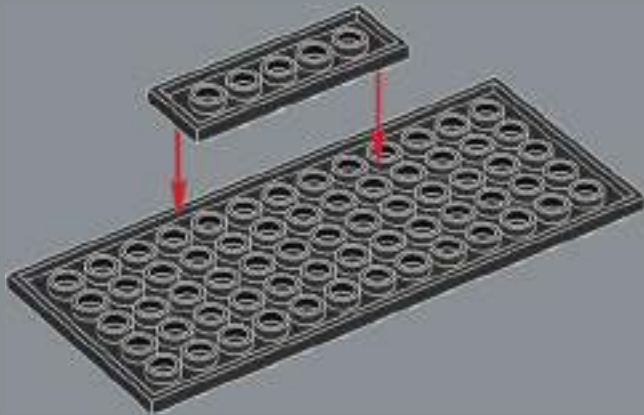

2

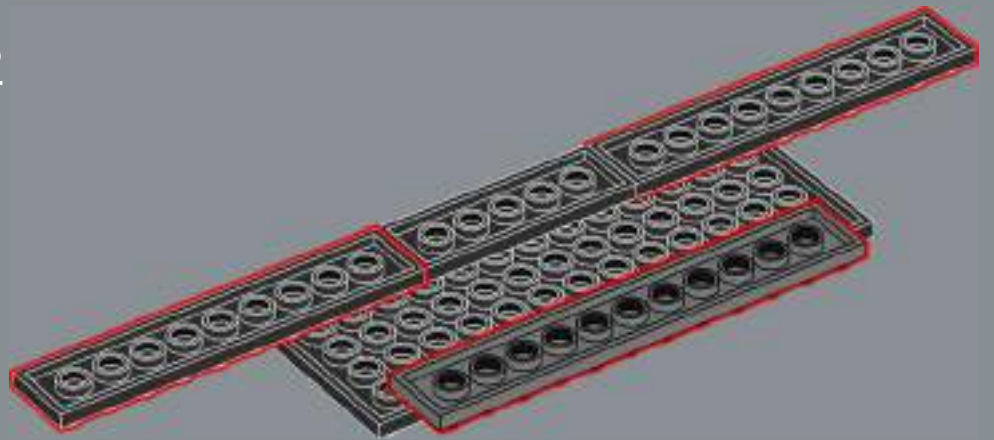

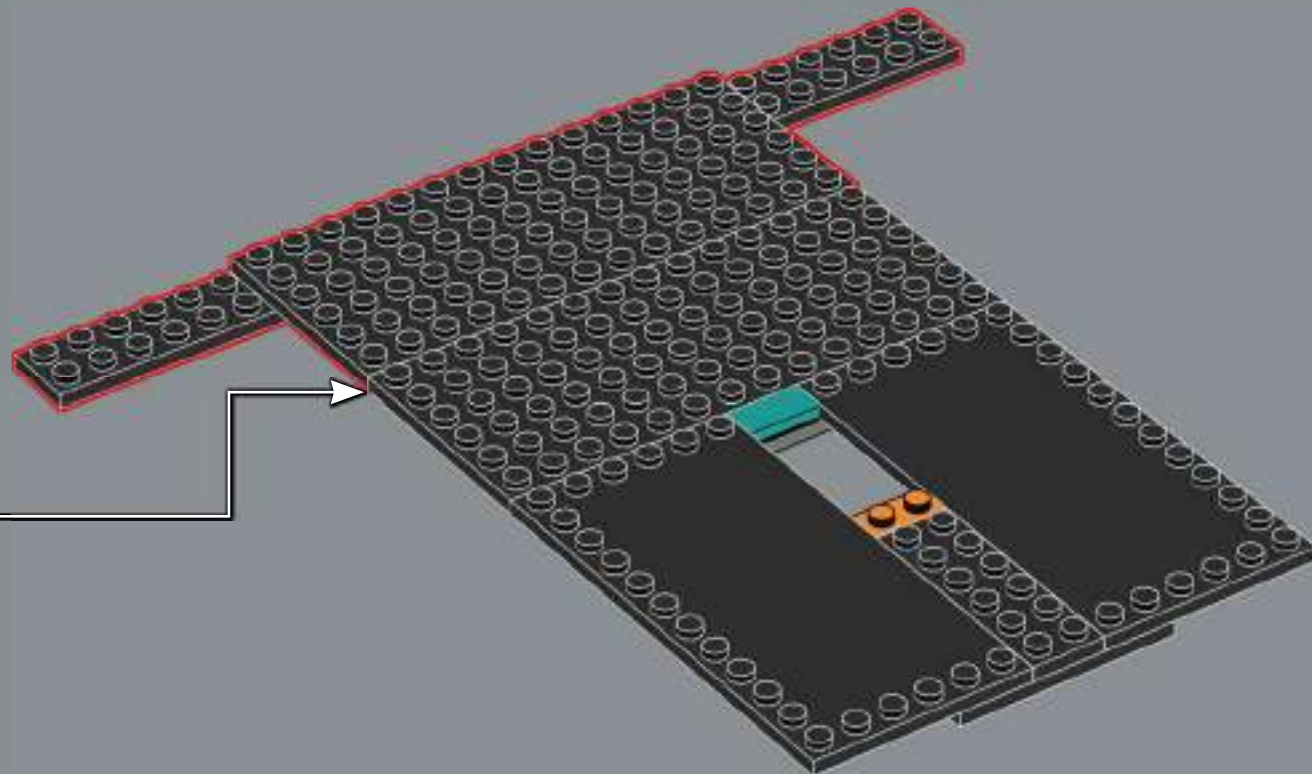

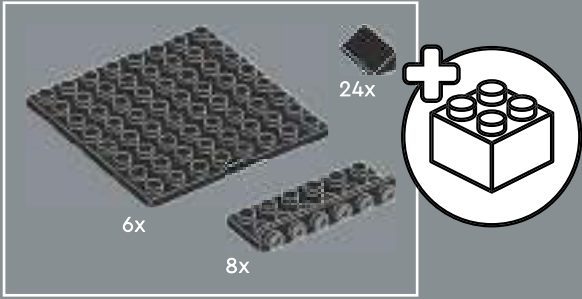
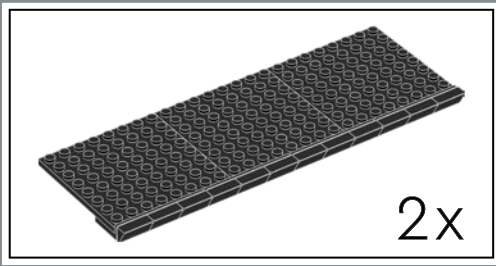

8

1

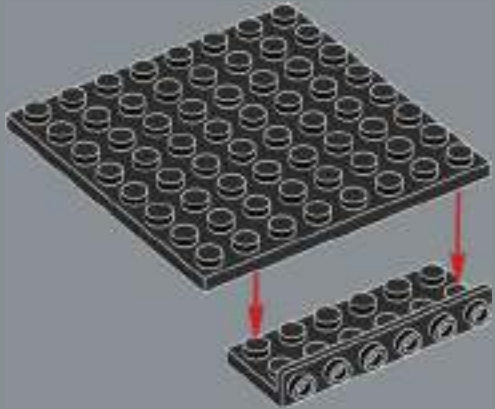

2

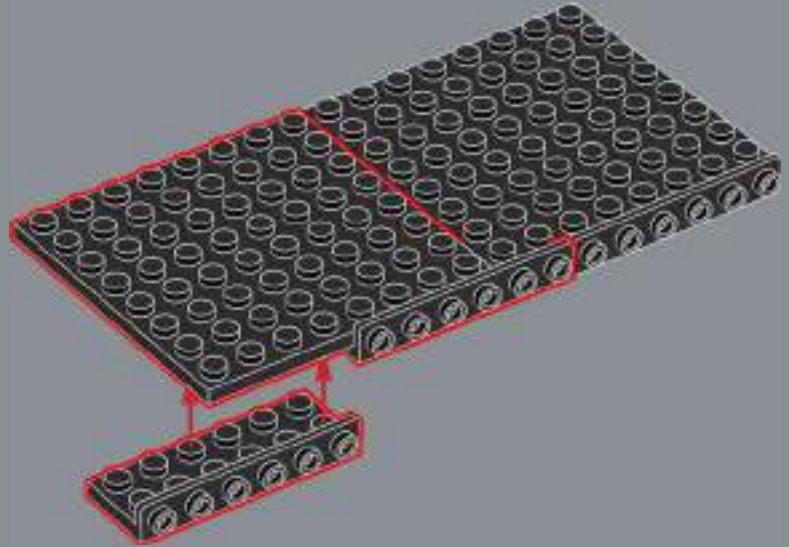

3

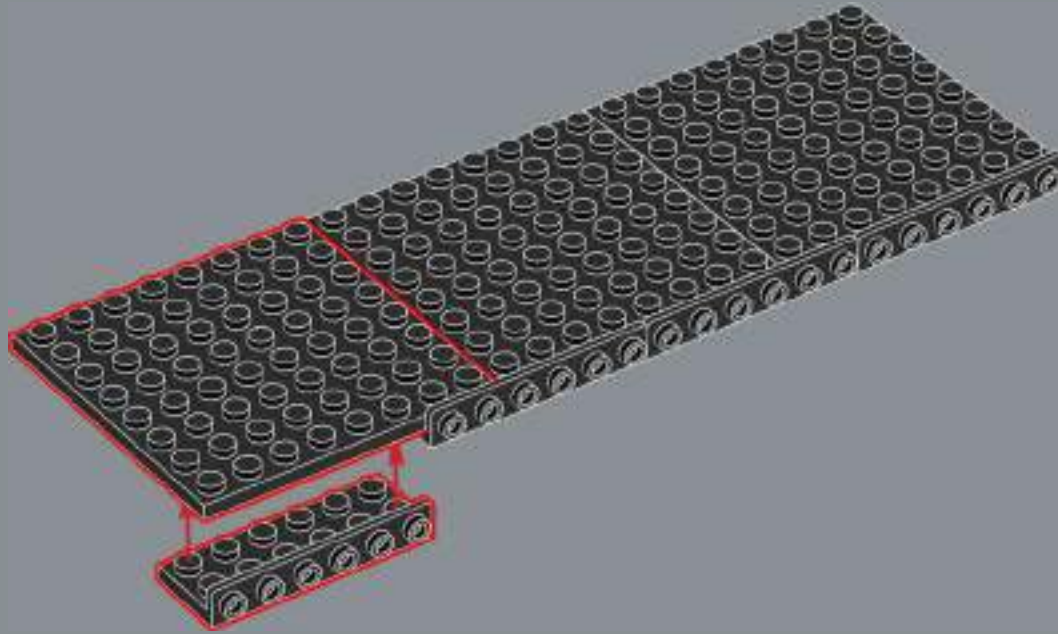

4

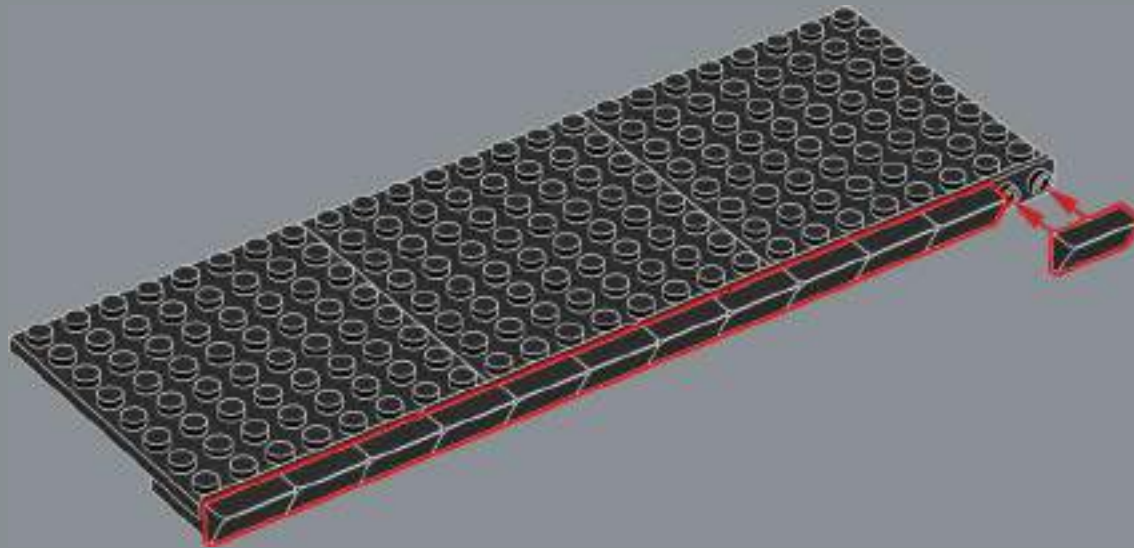

2x

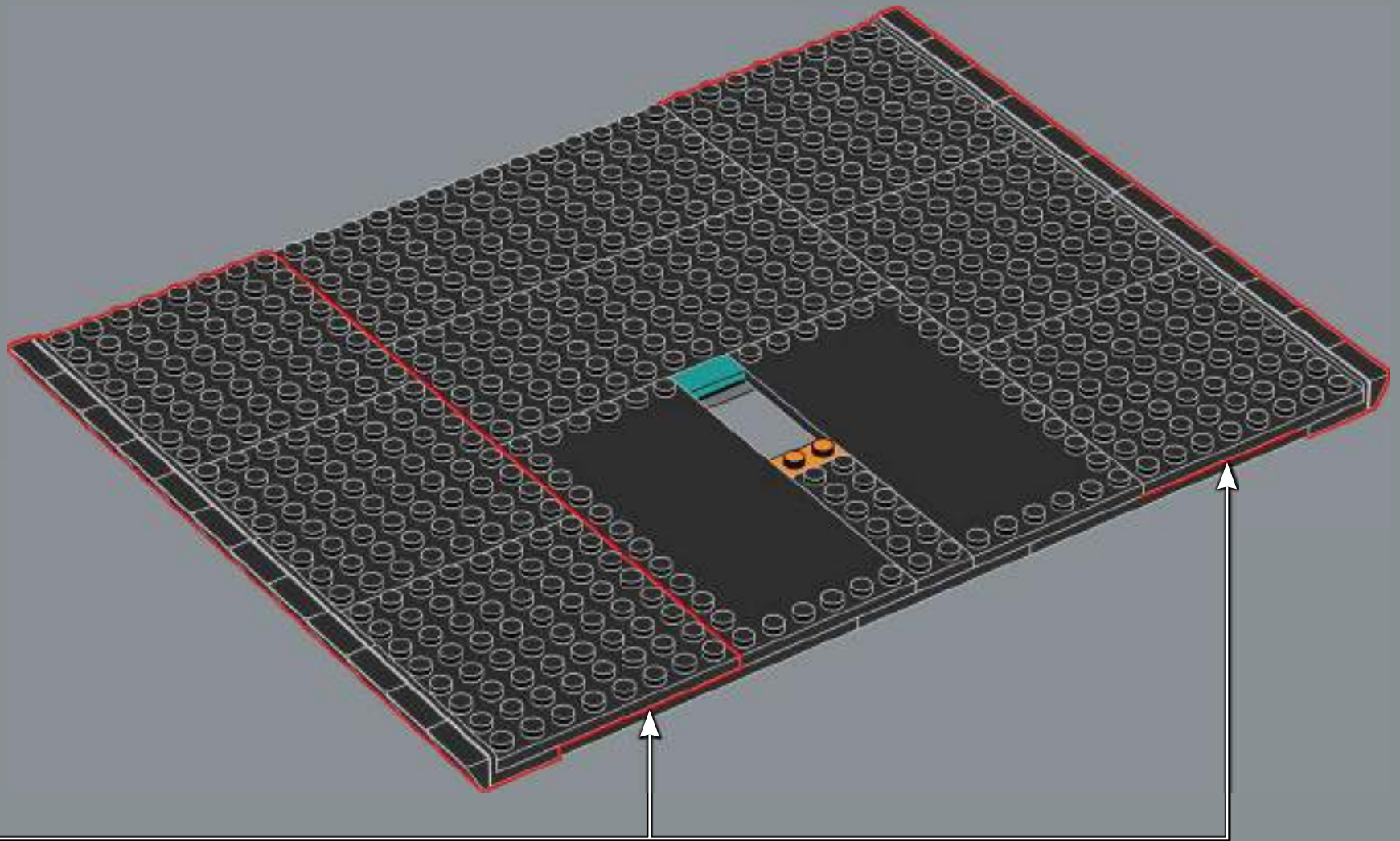

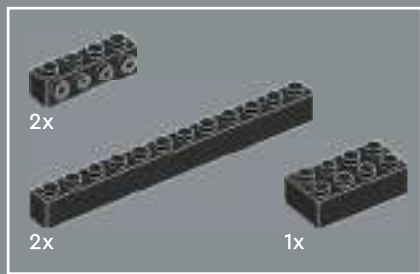

9

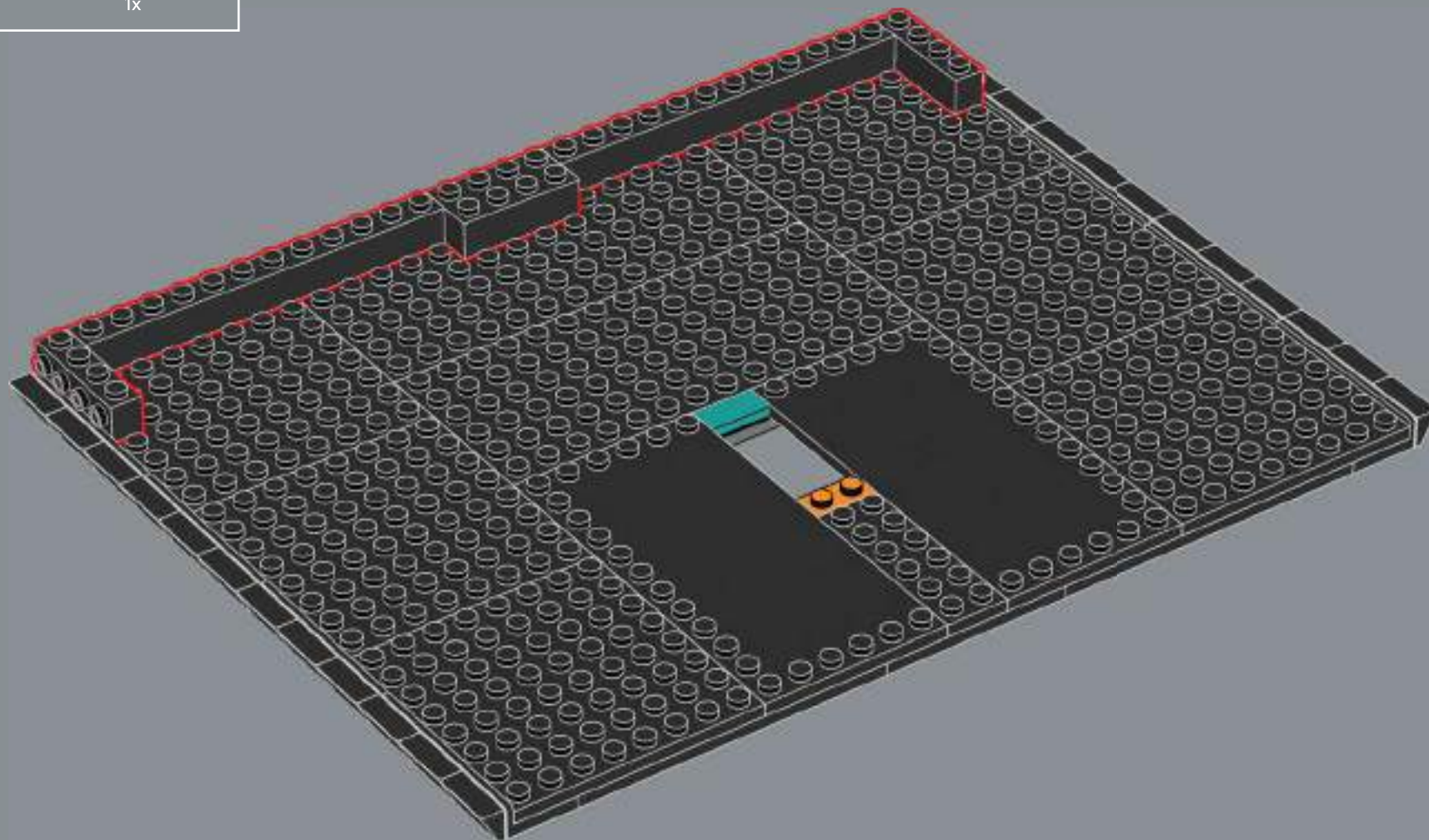

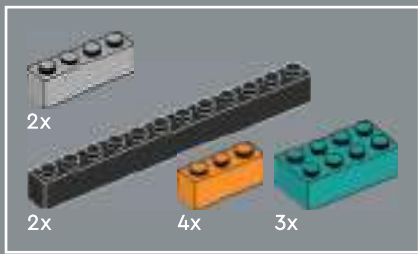

10

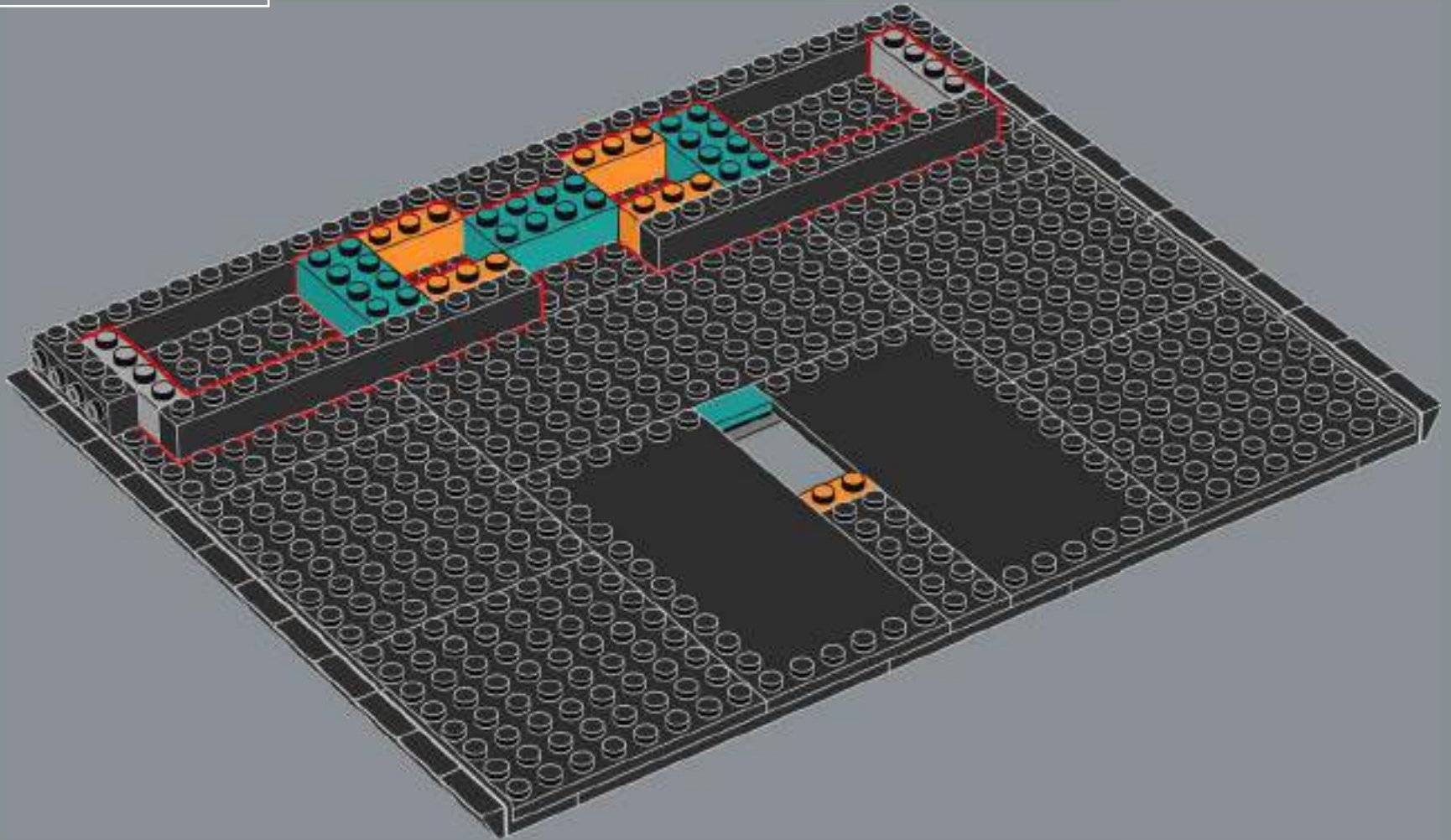

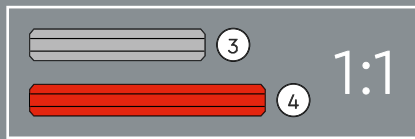
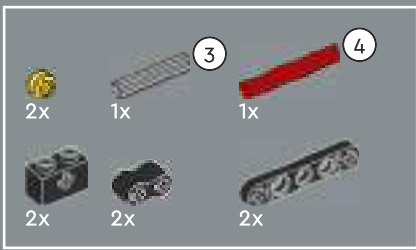

11

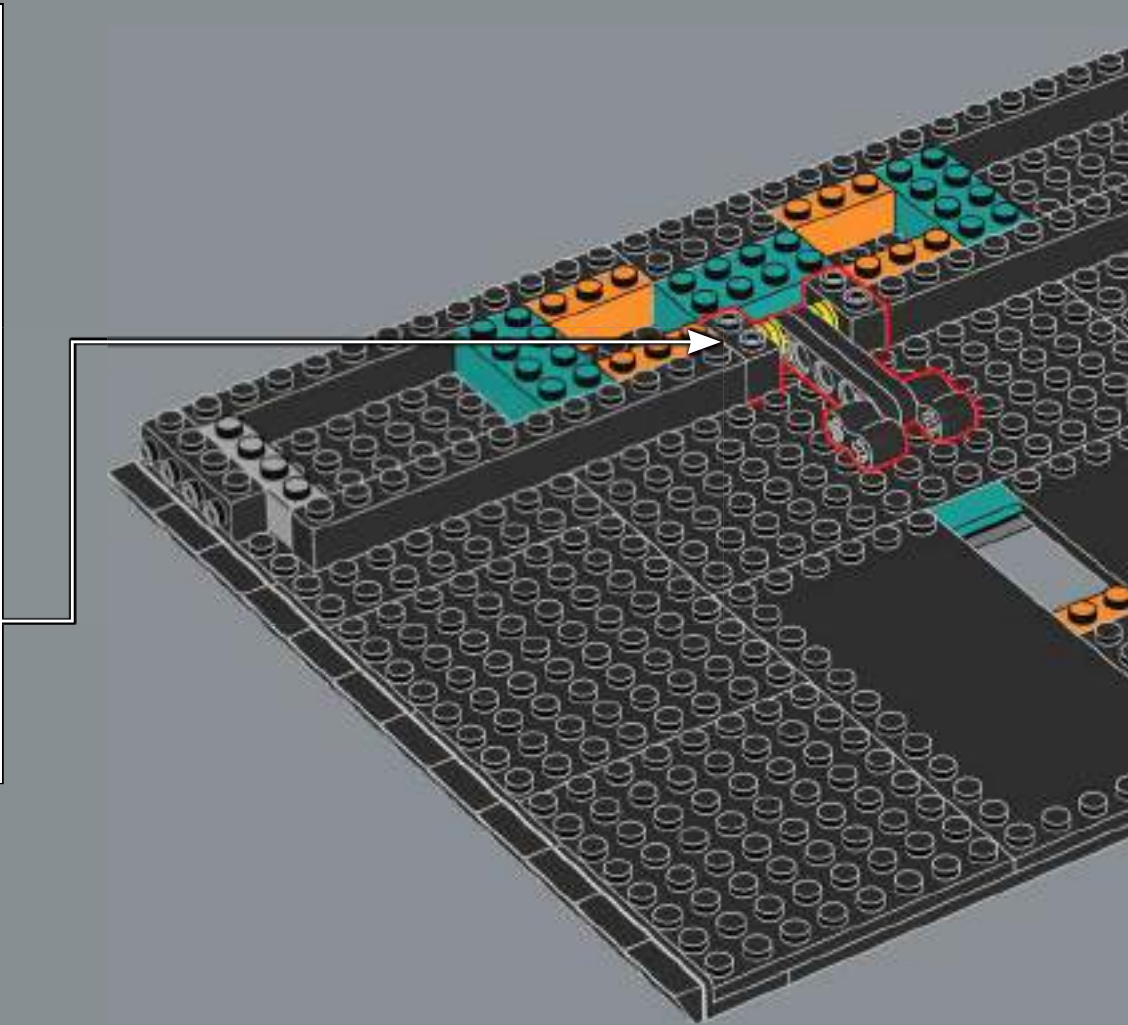
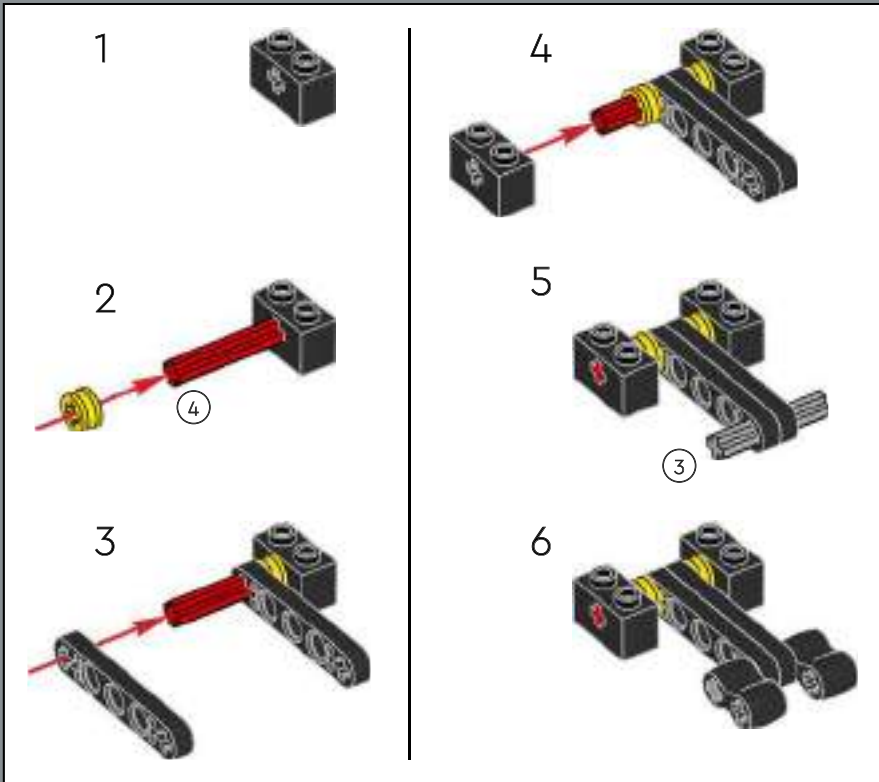

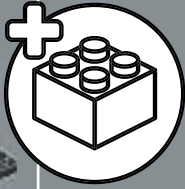
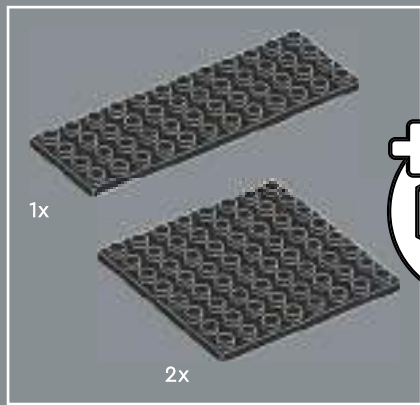

12

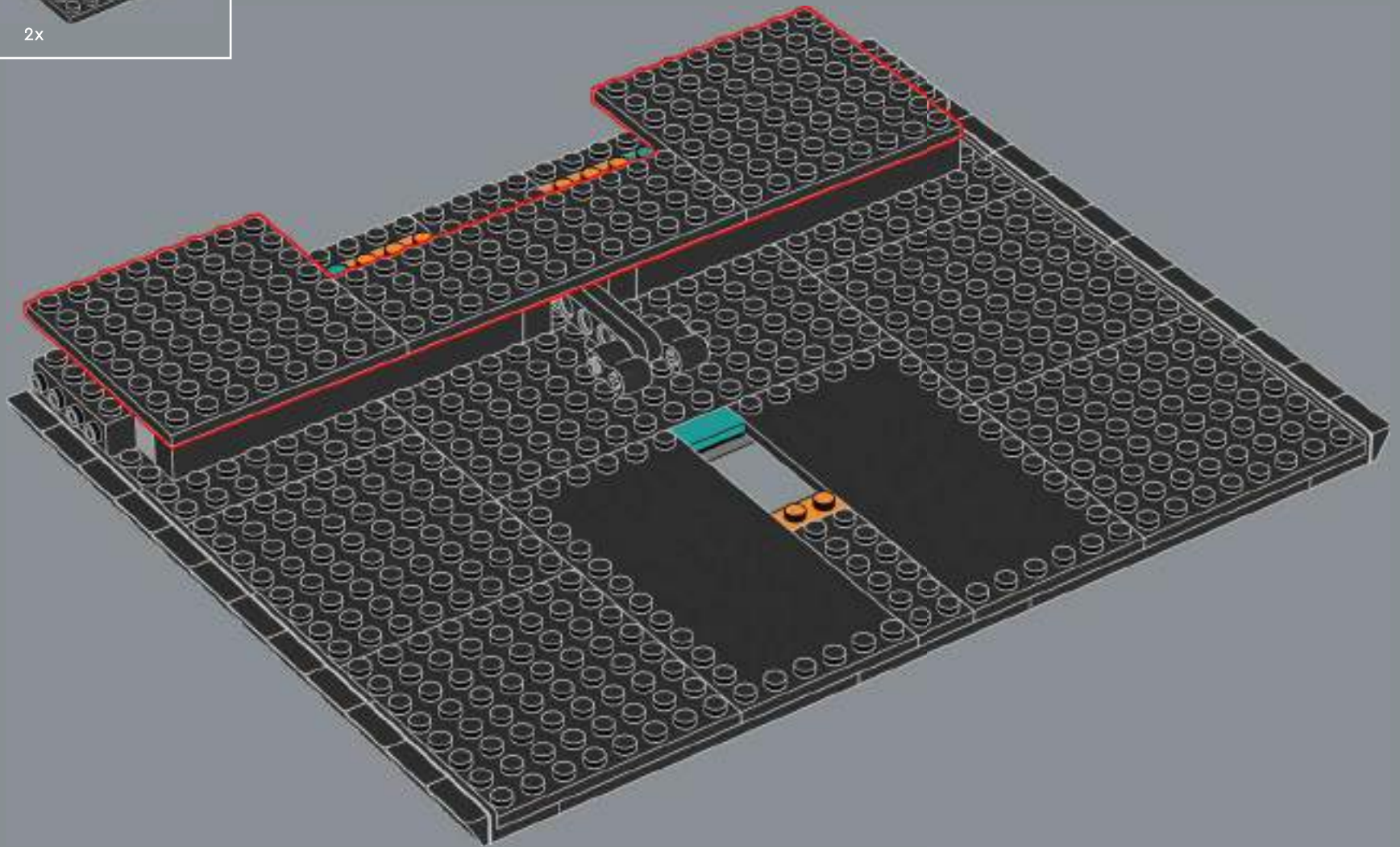

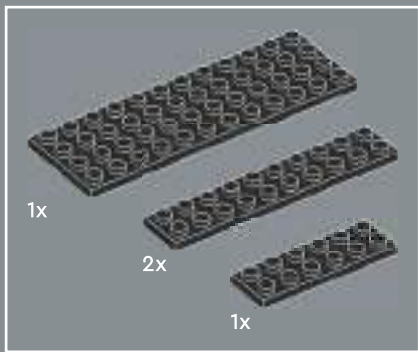

13

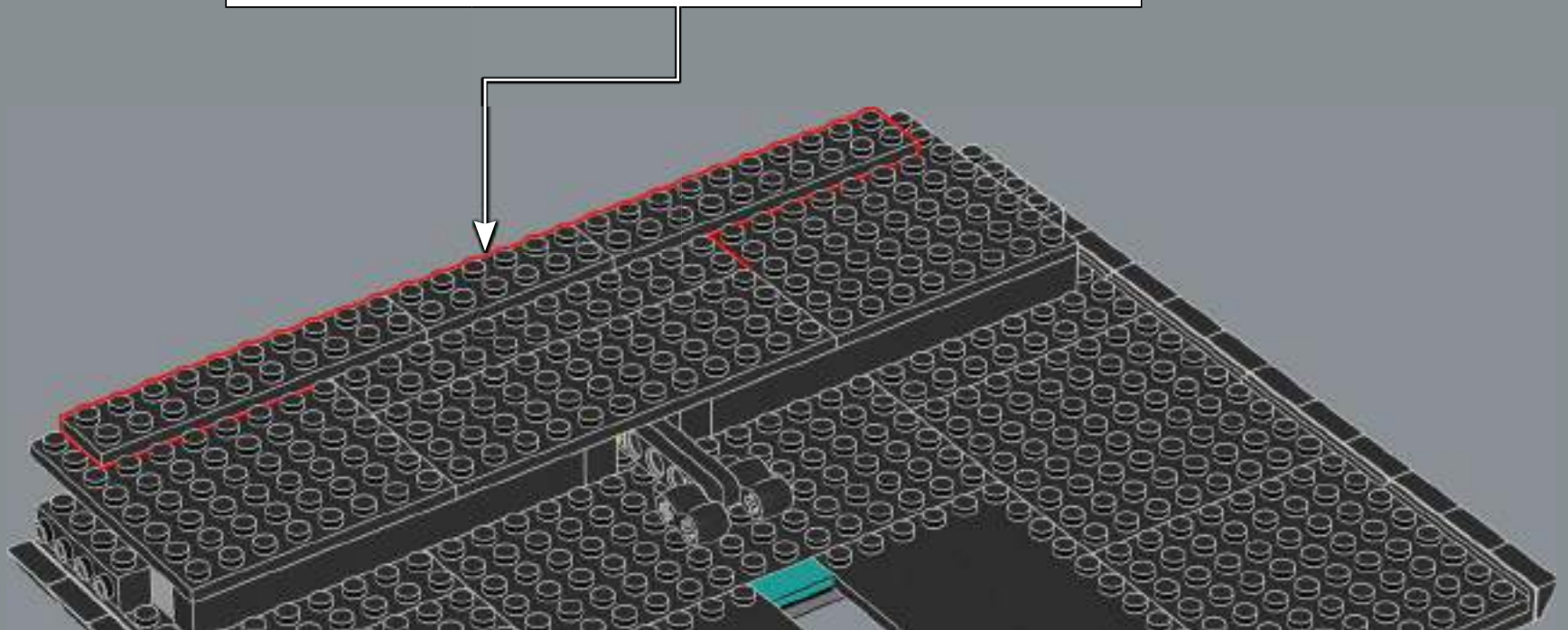
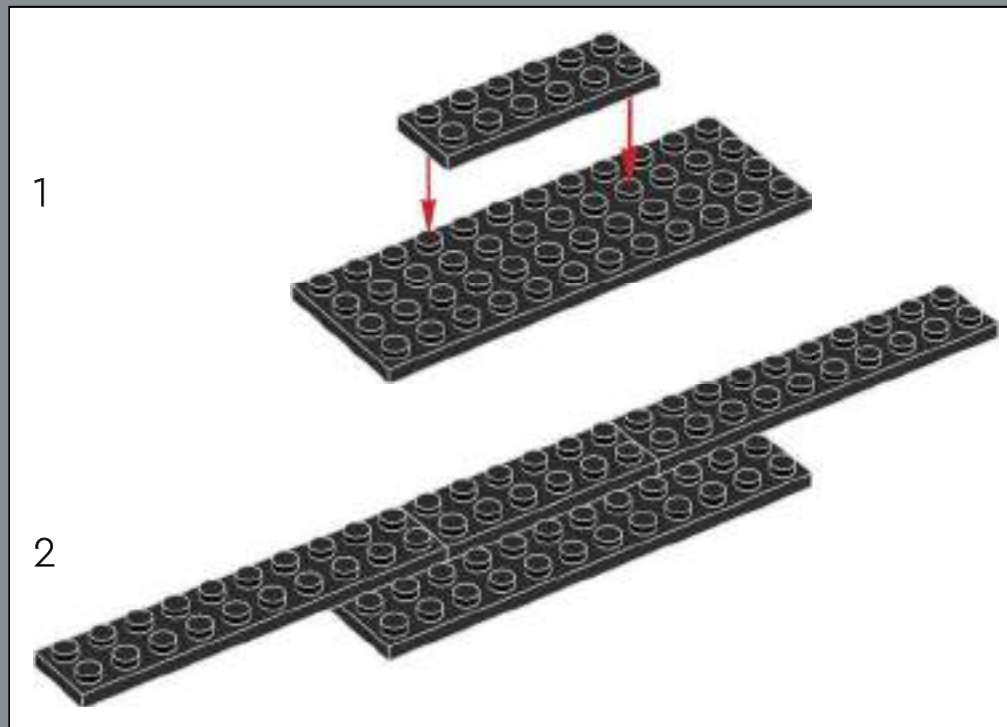

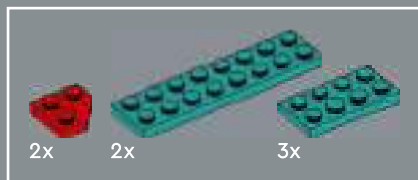

14

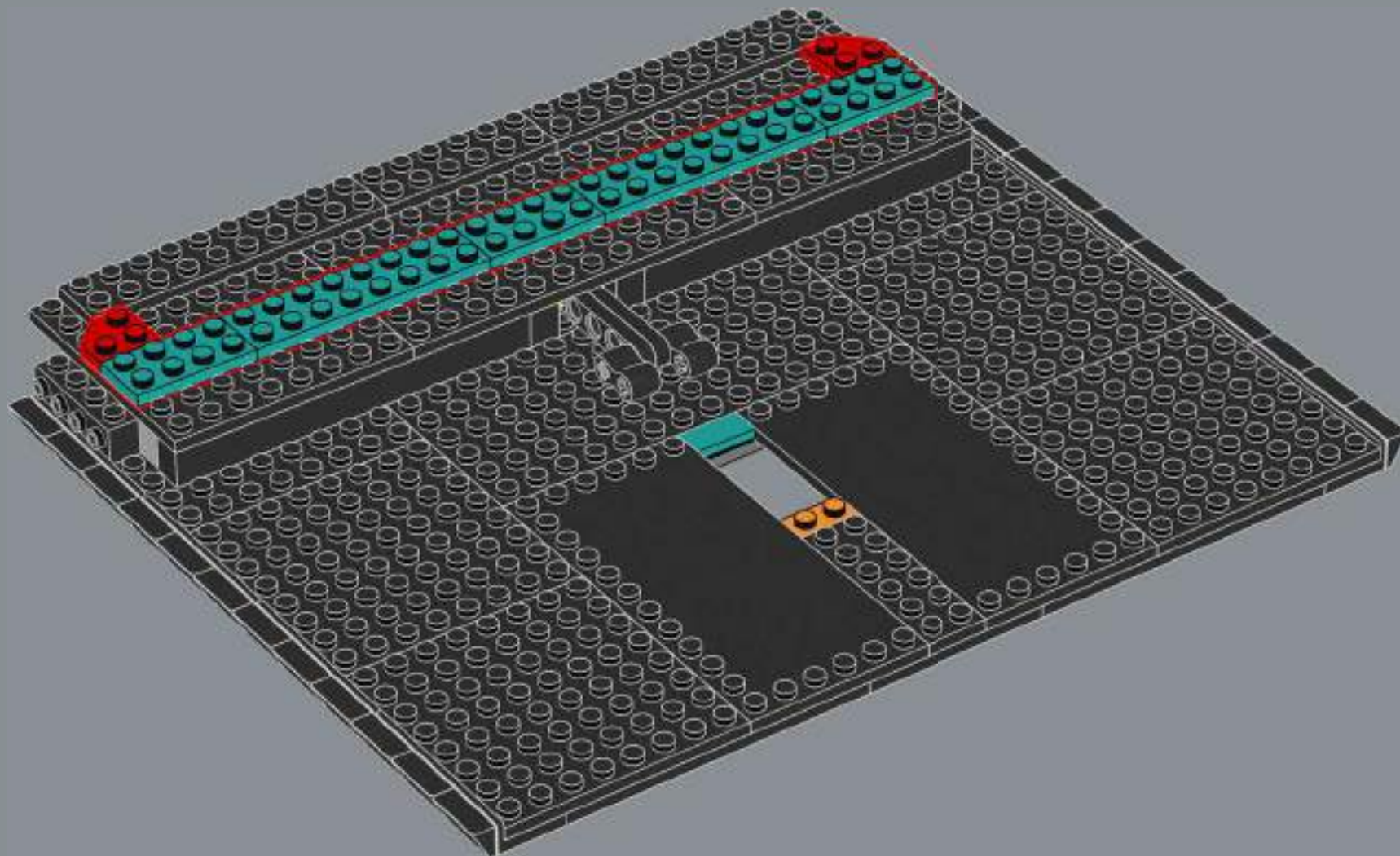

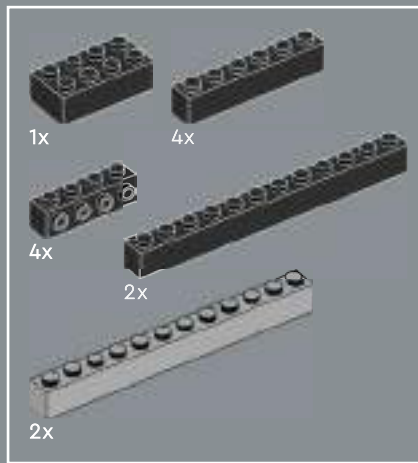

16

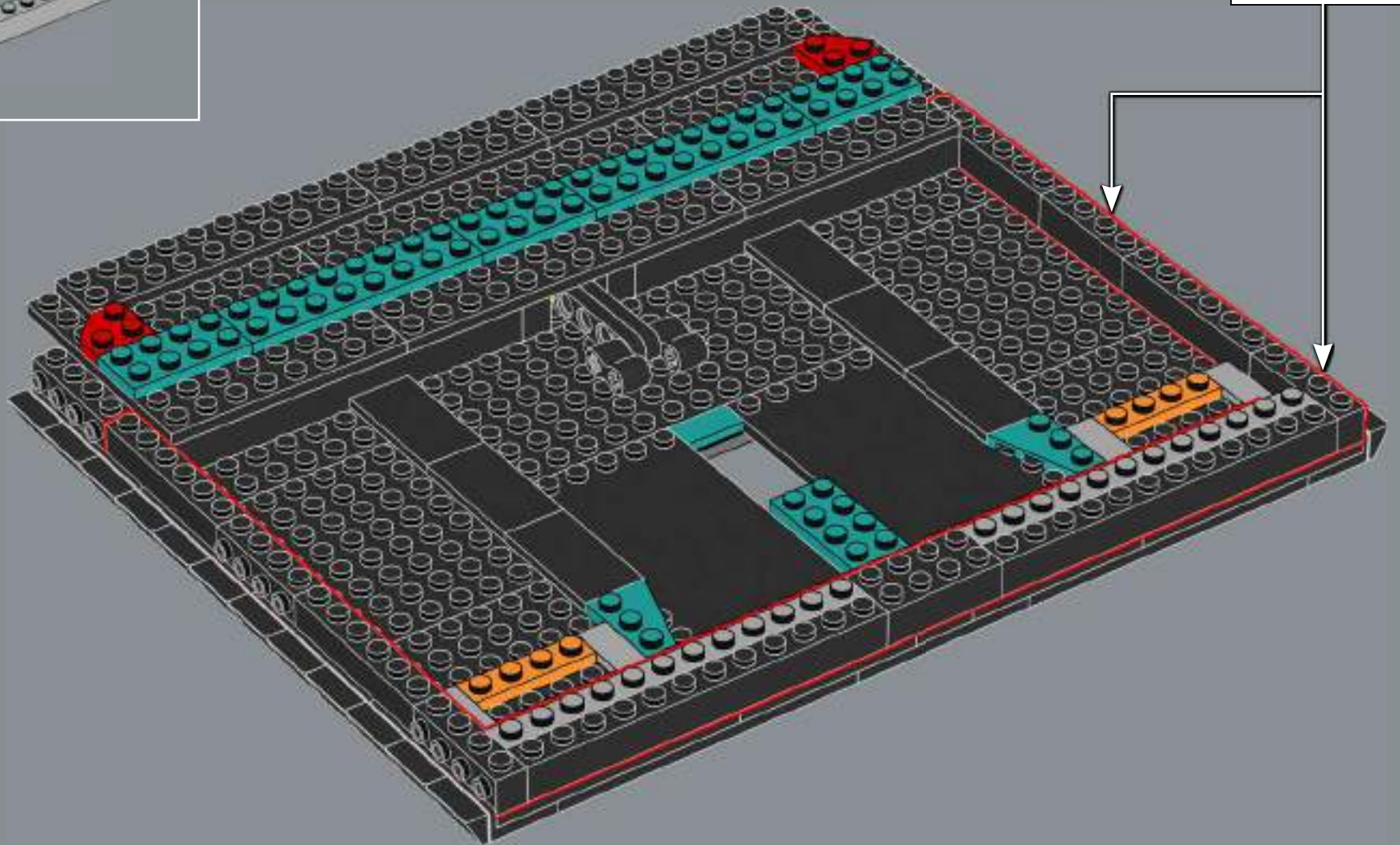

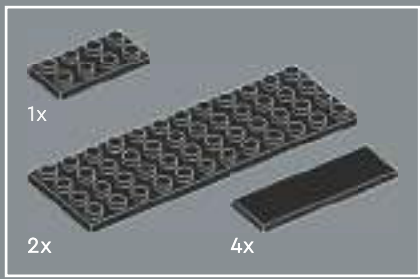

17

1

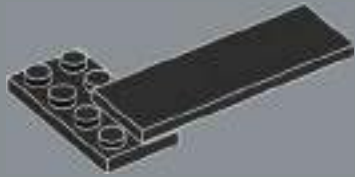

2

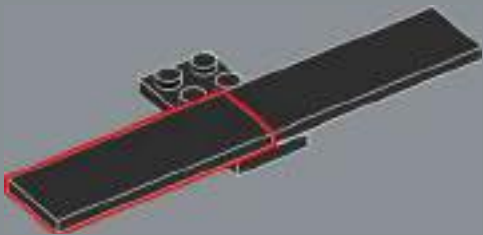

3

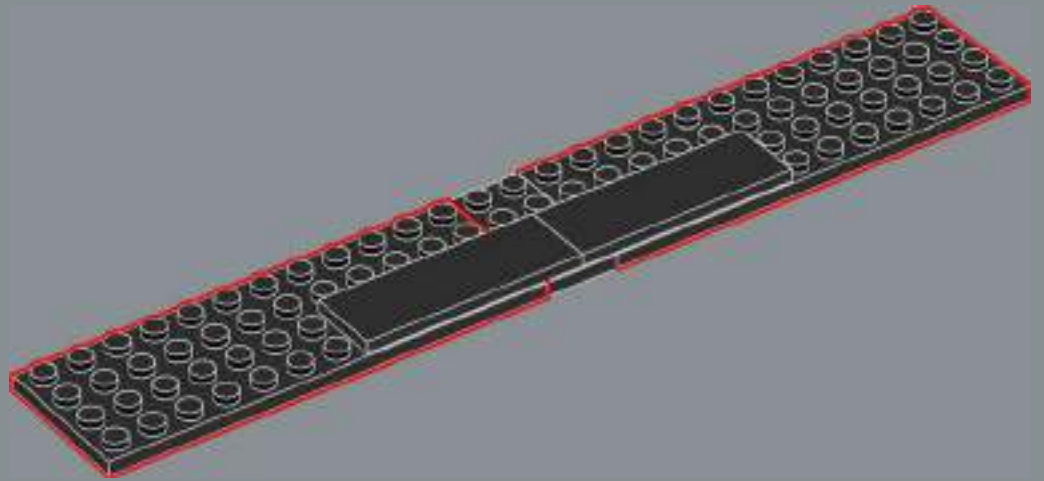

4

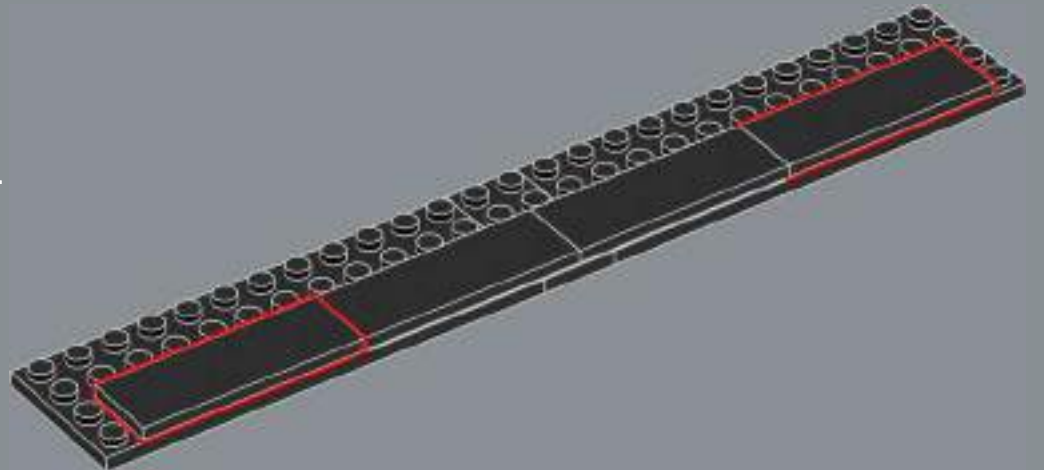

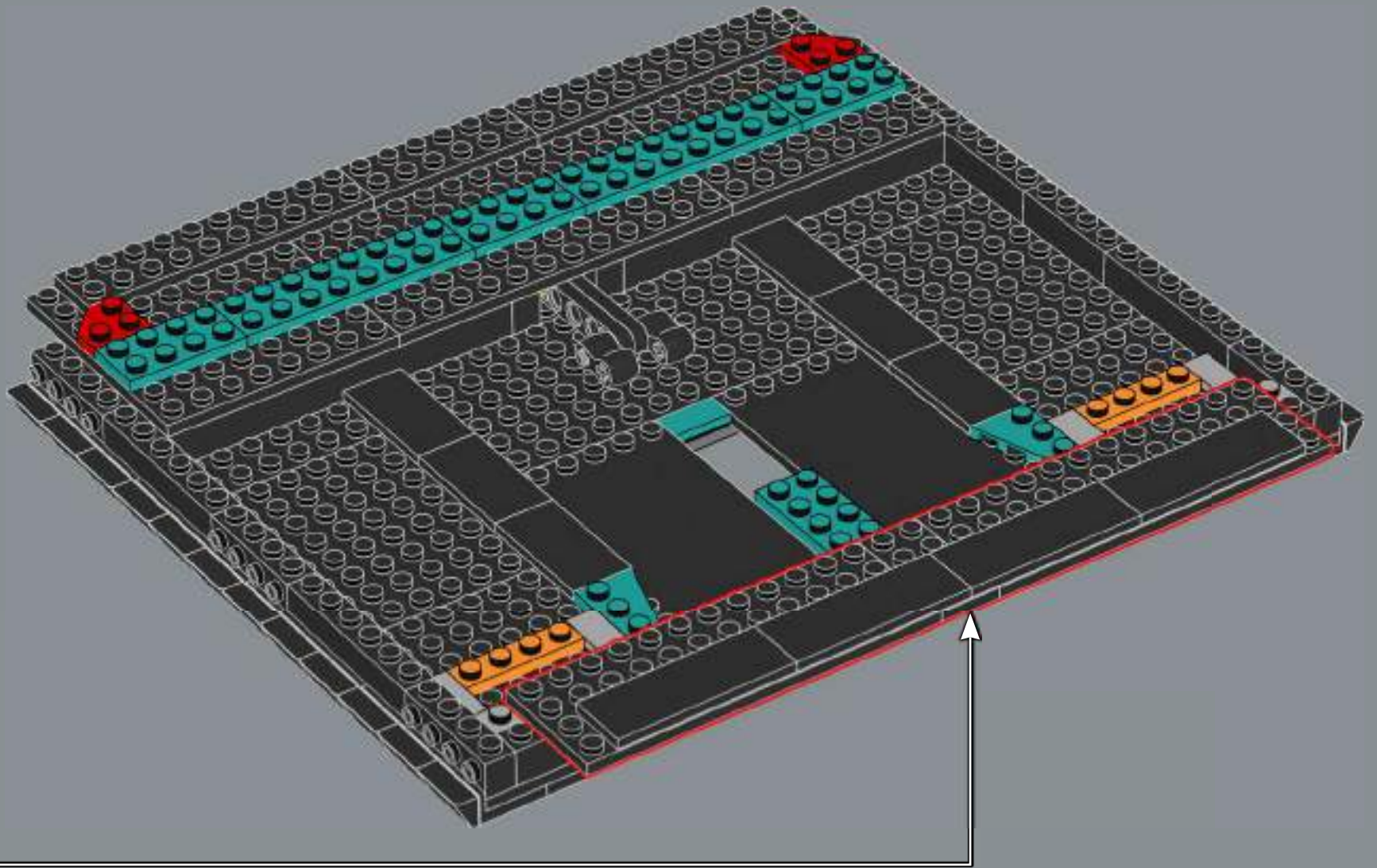

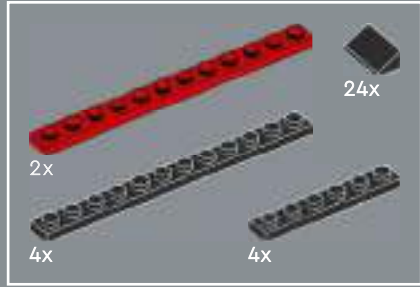

18

1

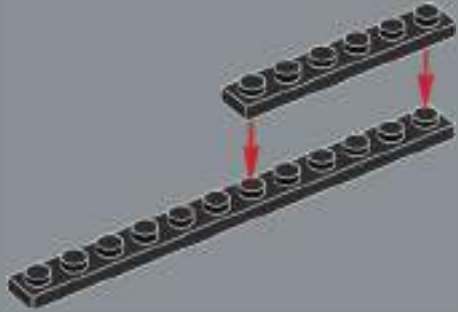

2



3

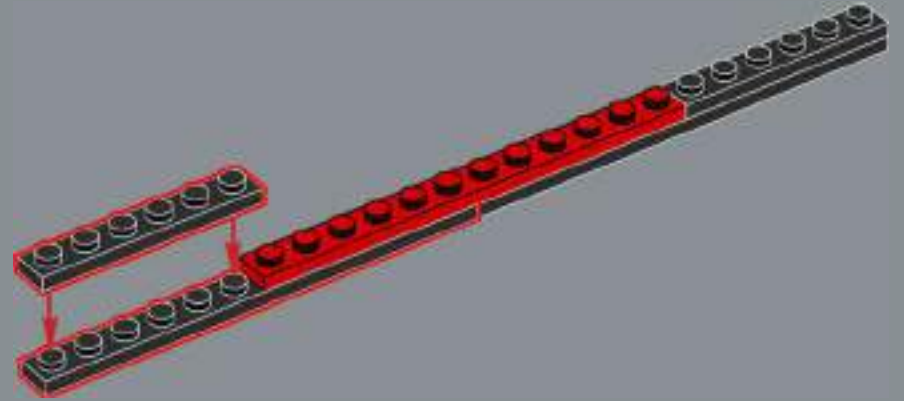

4

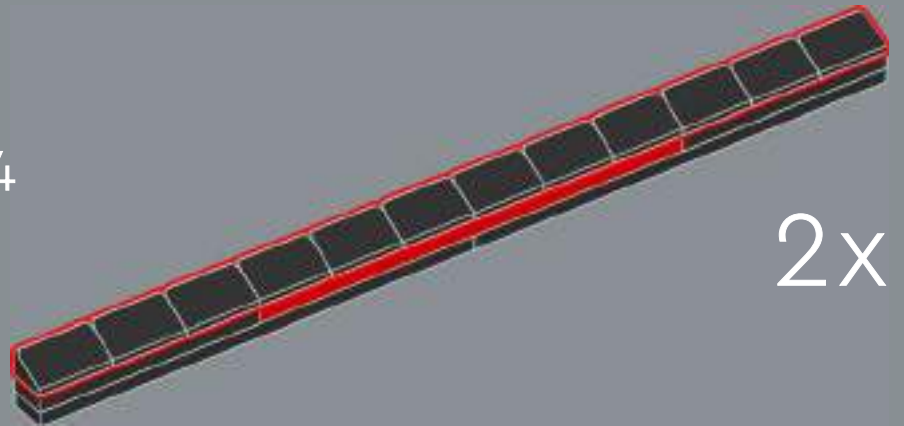

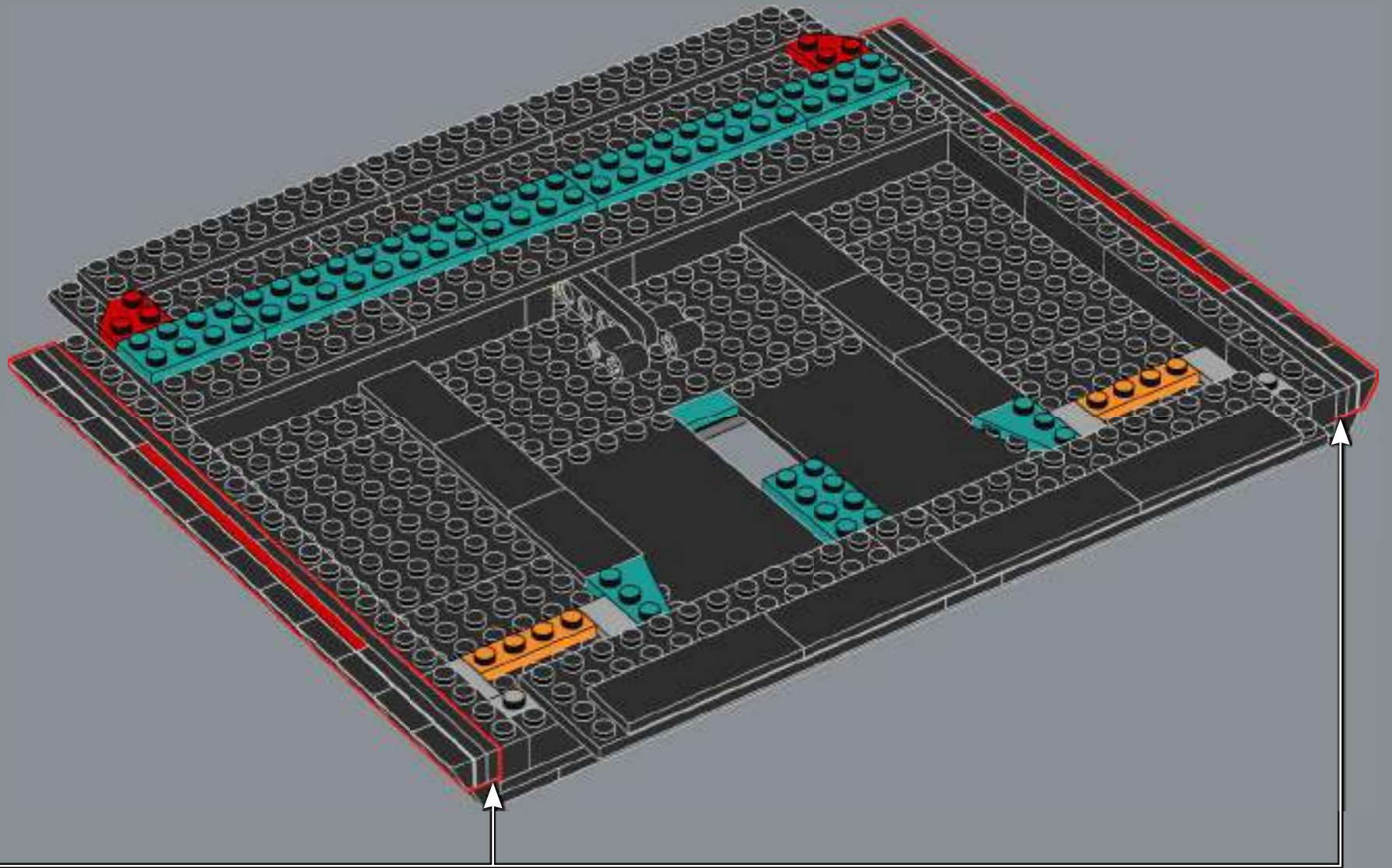

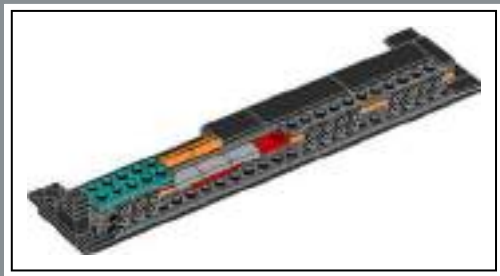

19

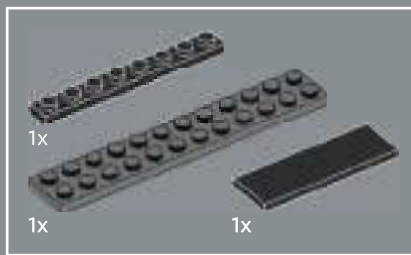
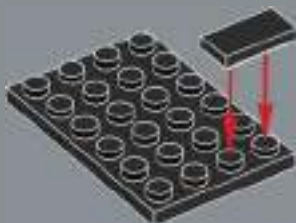

20

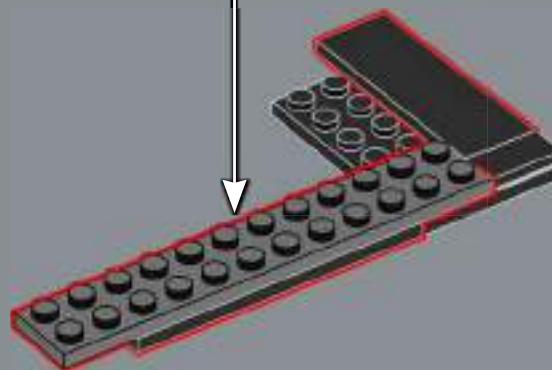
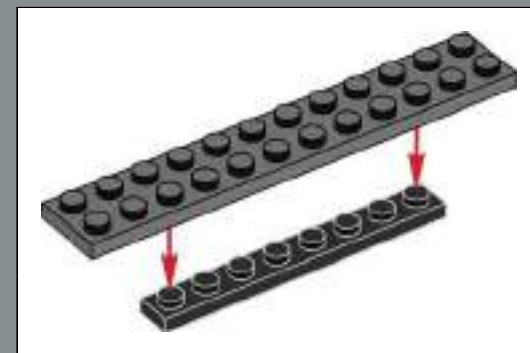

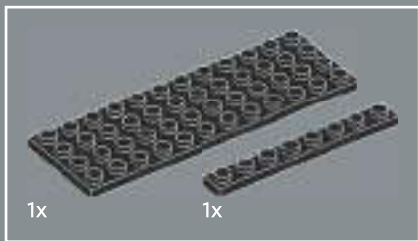

21

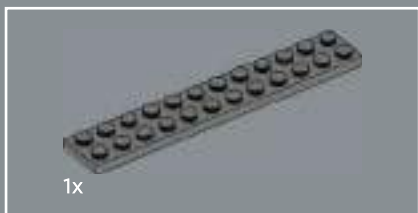
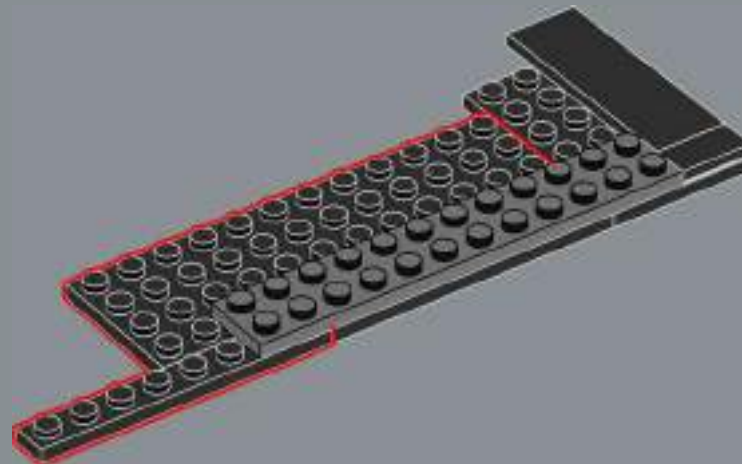

22

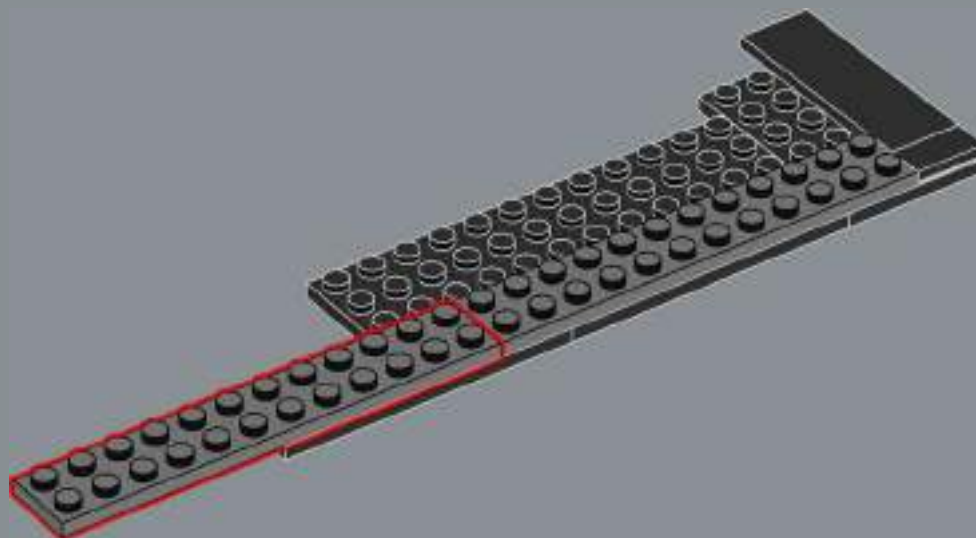

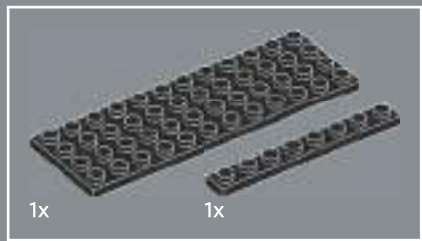

23

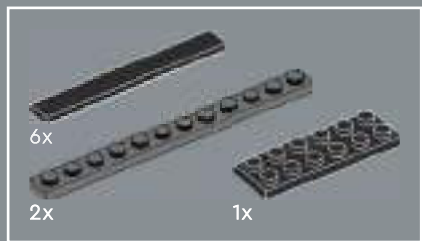
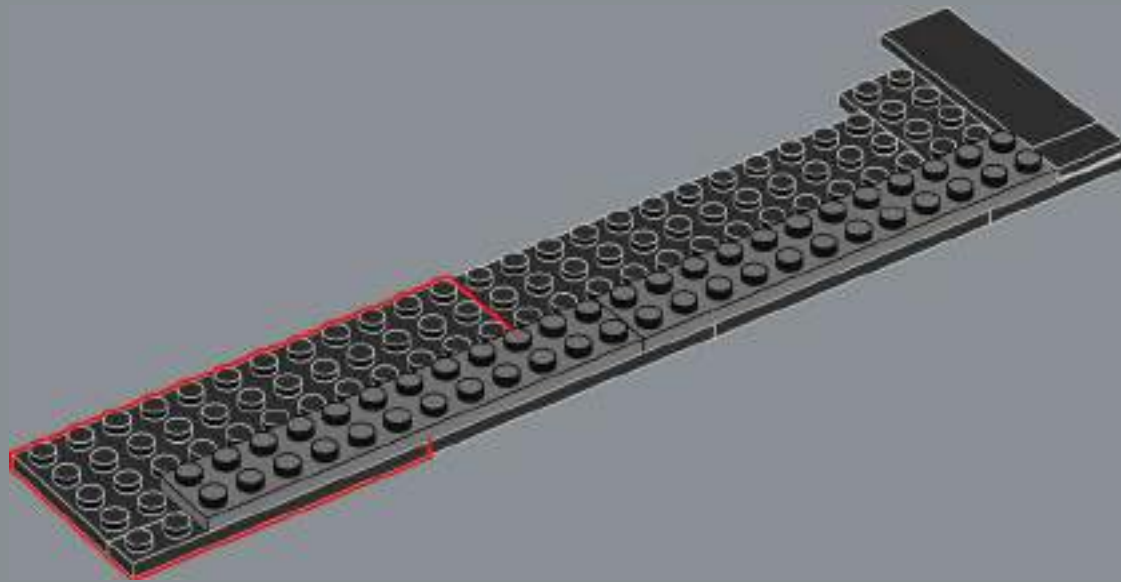

24

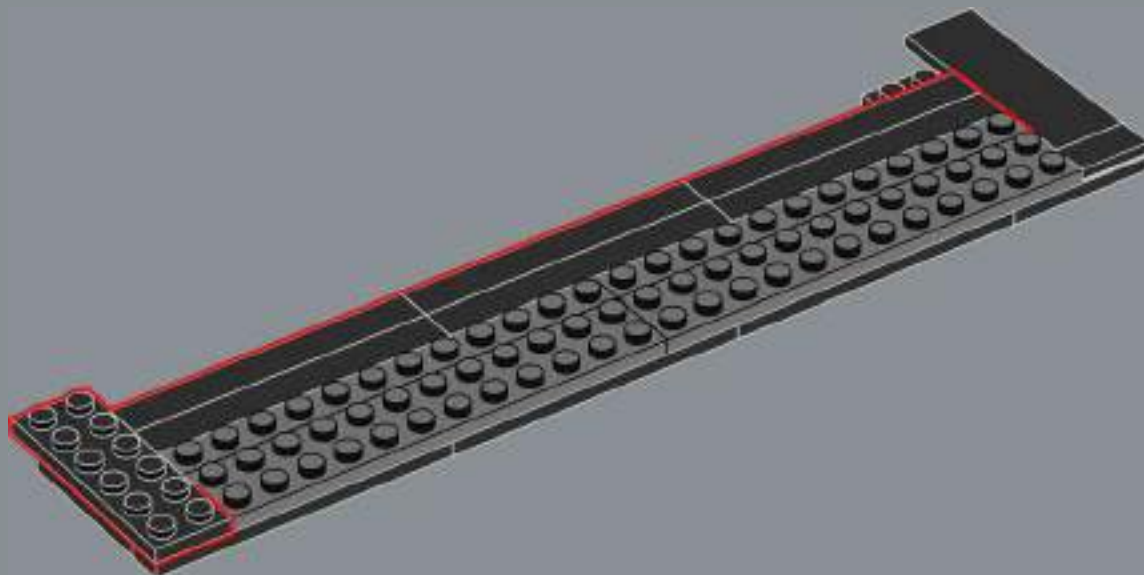

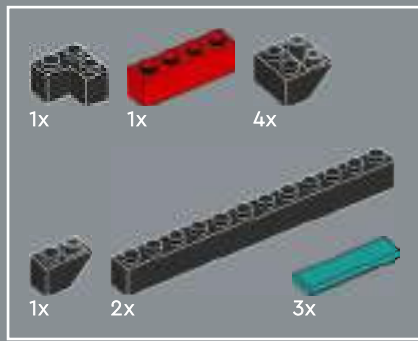

25

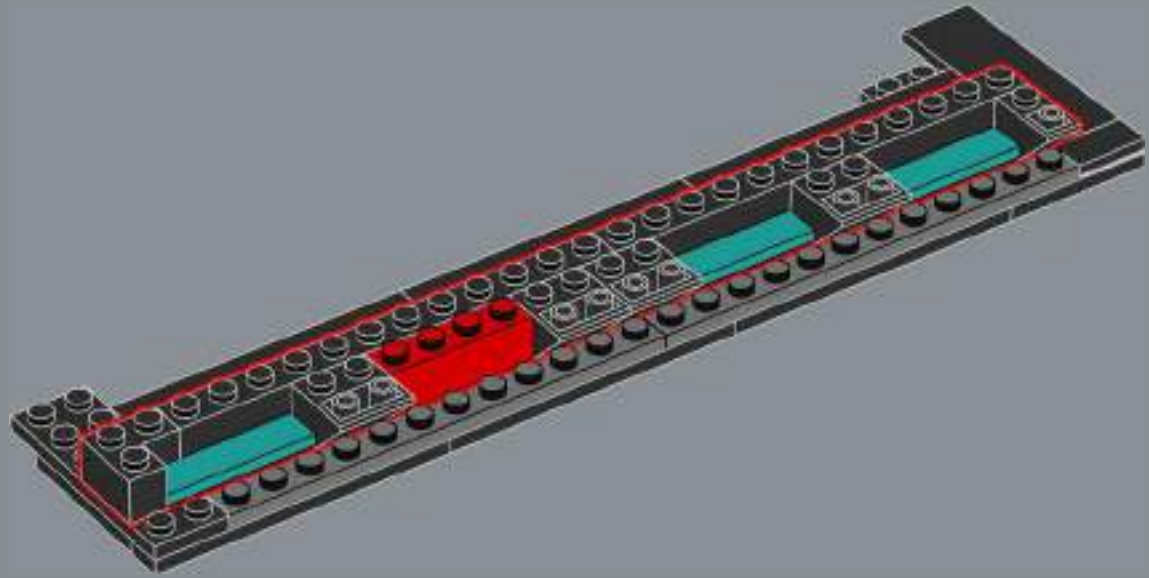

26

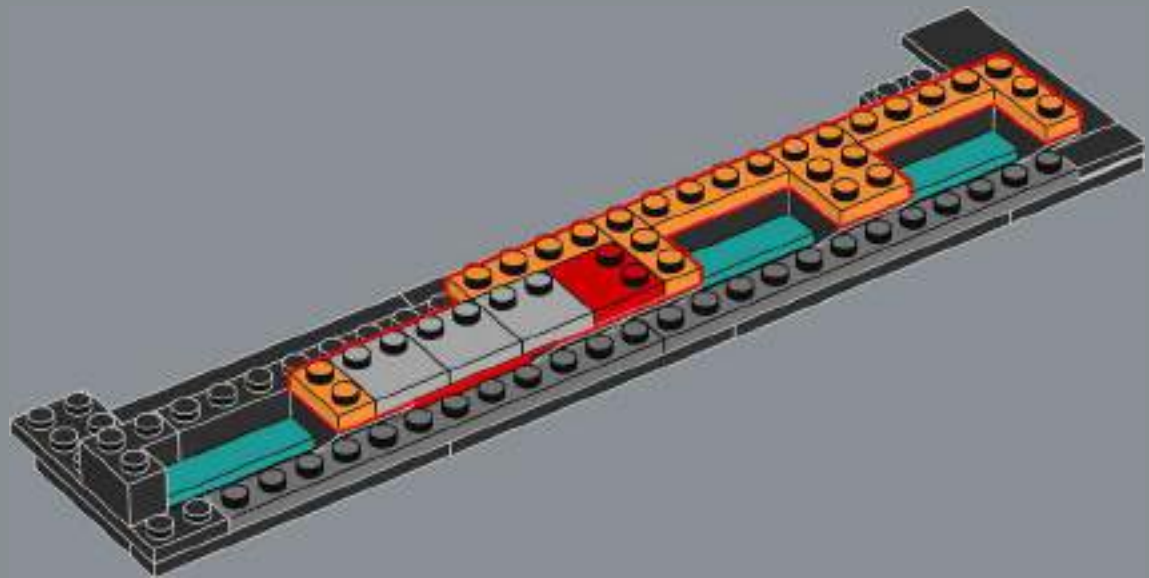

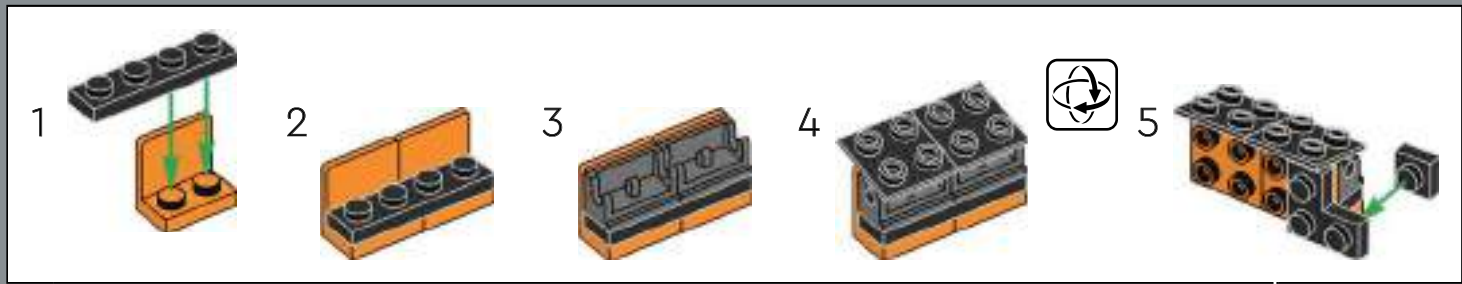

27

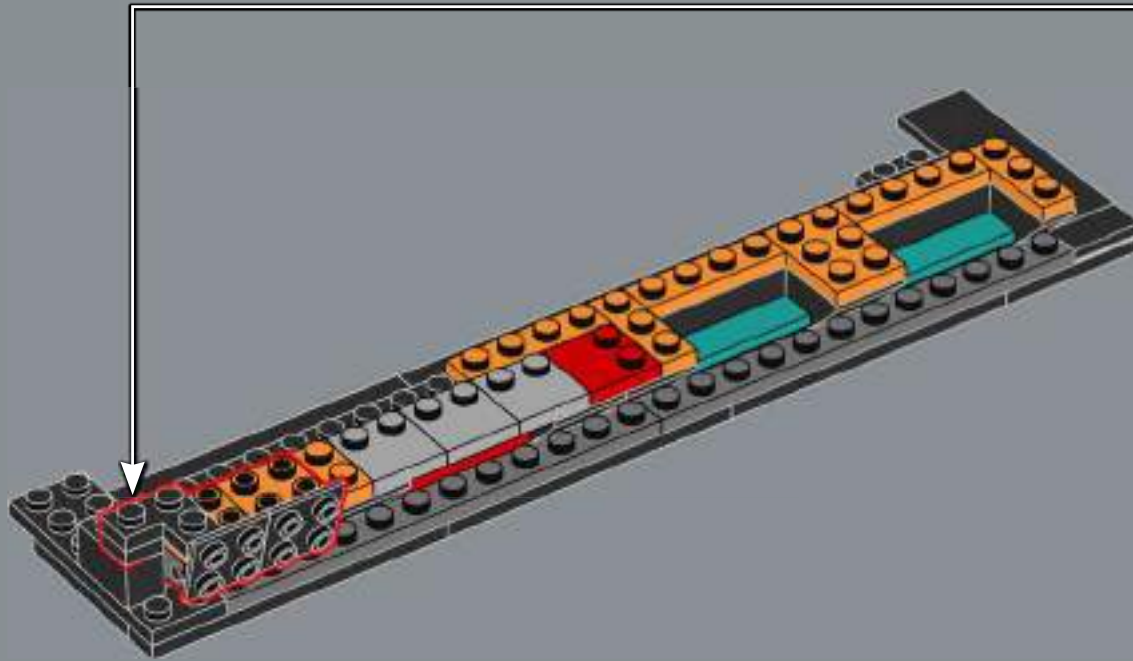

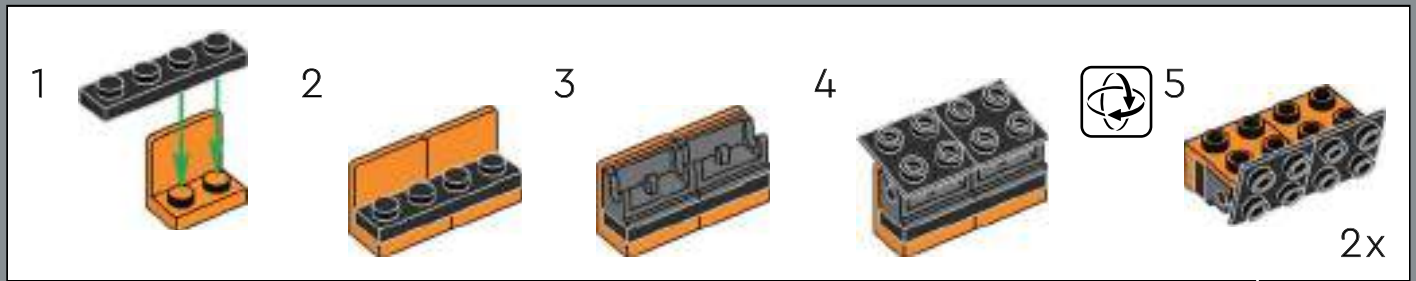
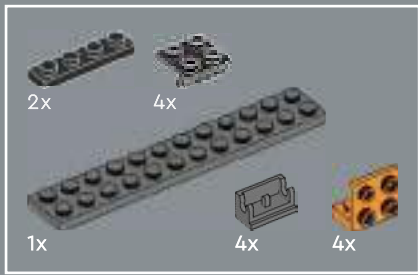

28

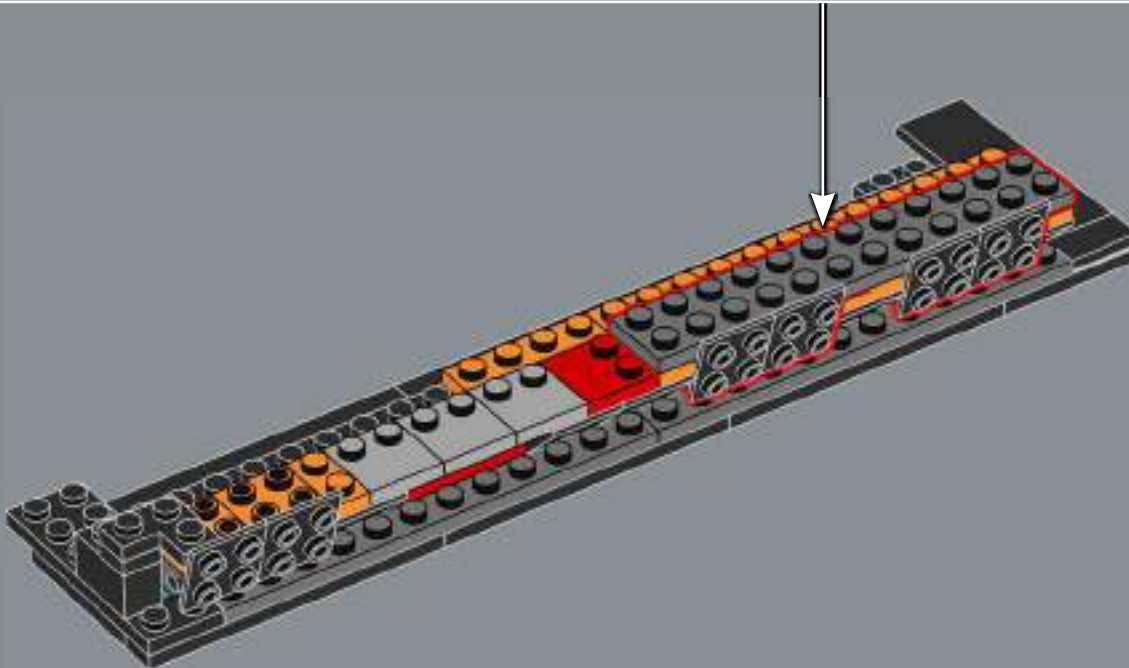
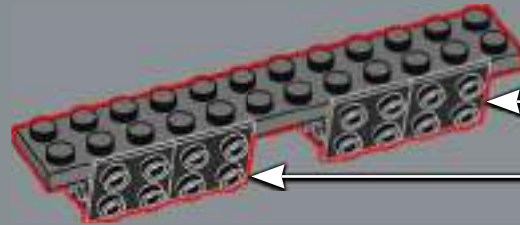

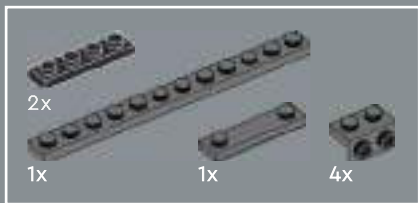

29

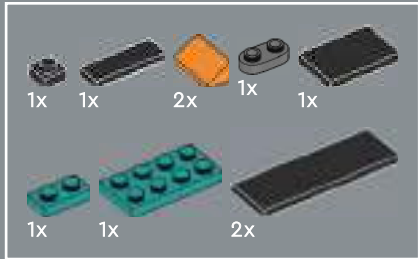
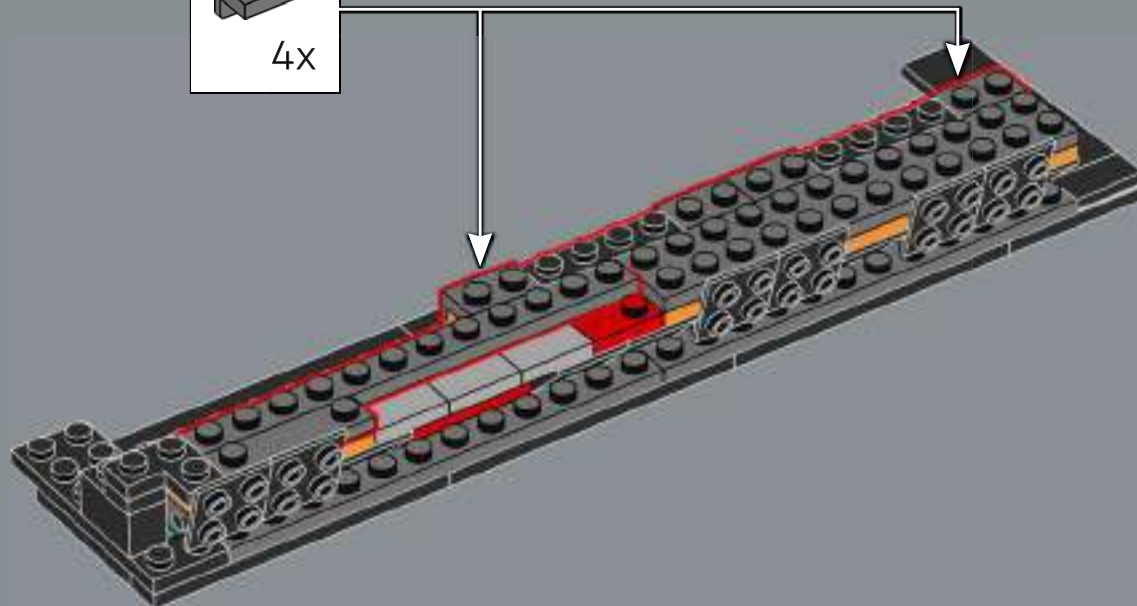
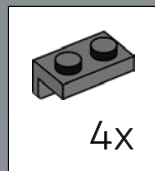

30

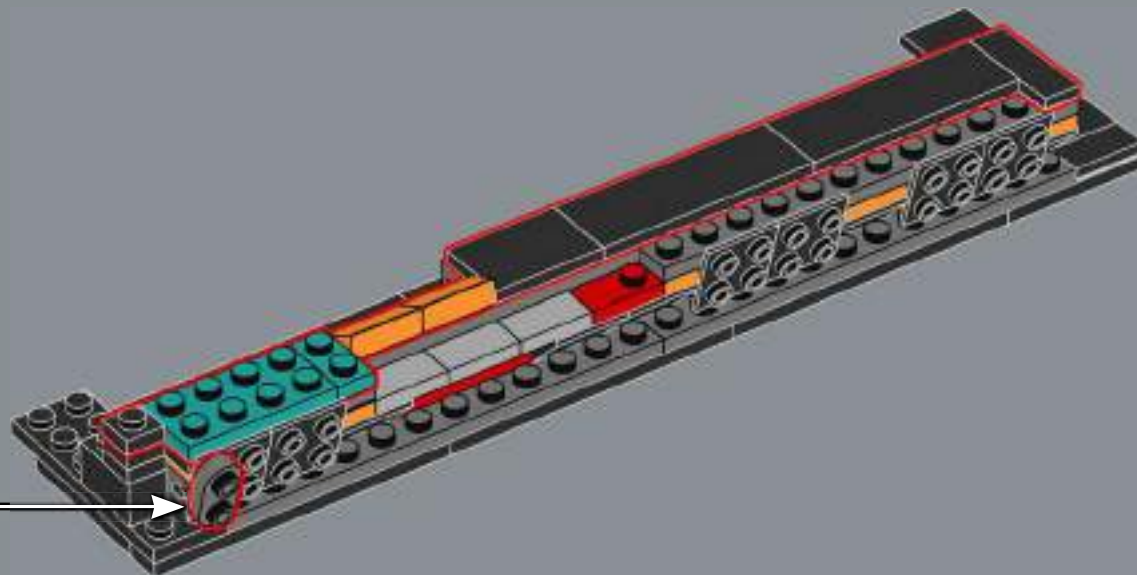

31

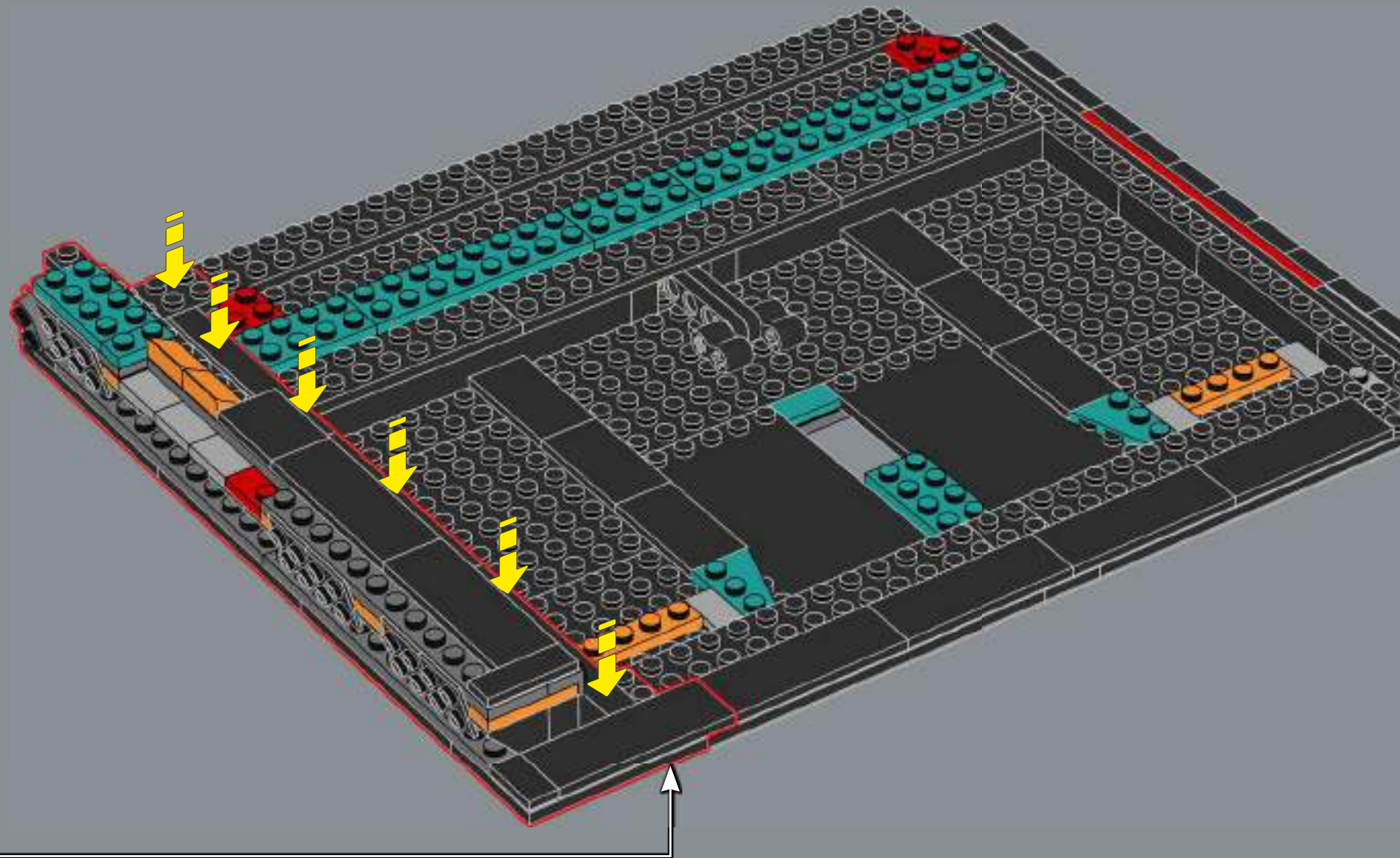

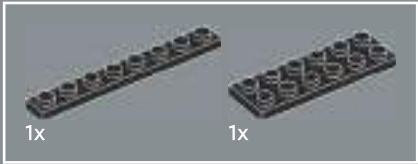
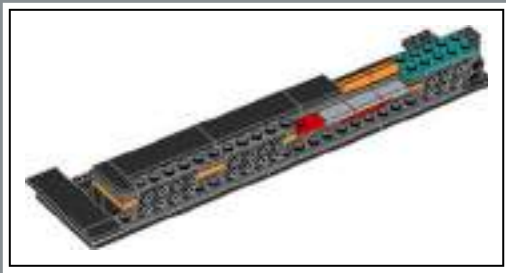

32

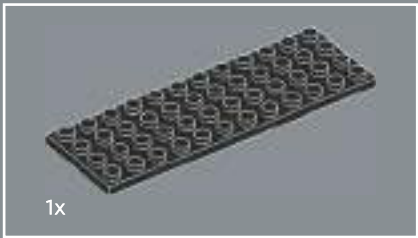
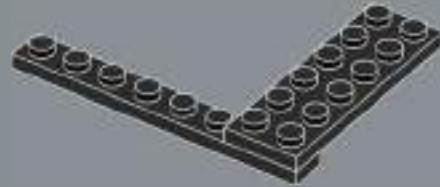

33

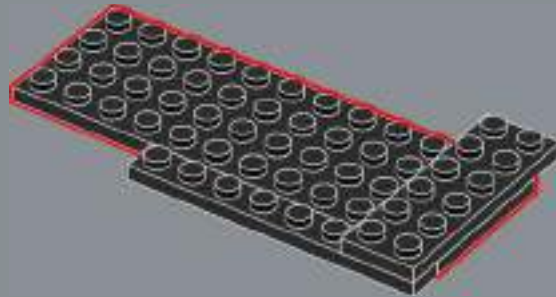

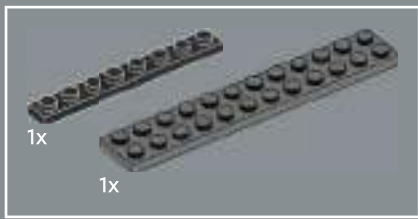

34

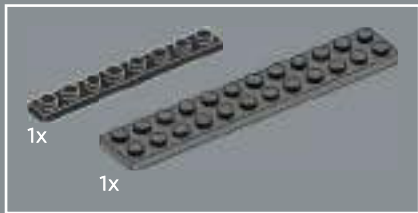
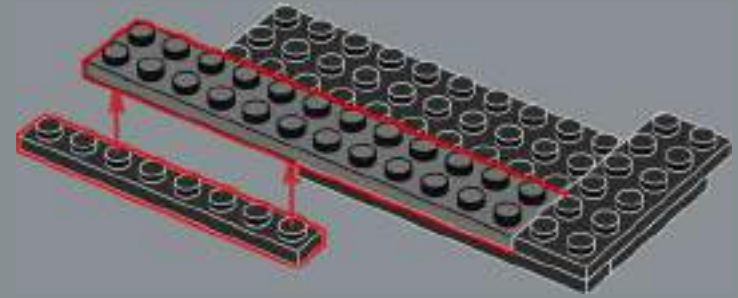

35

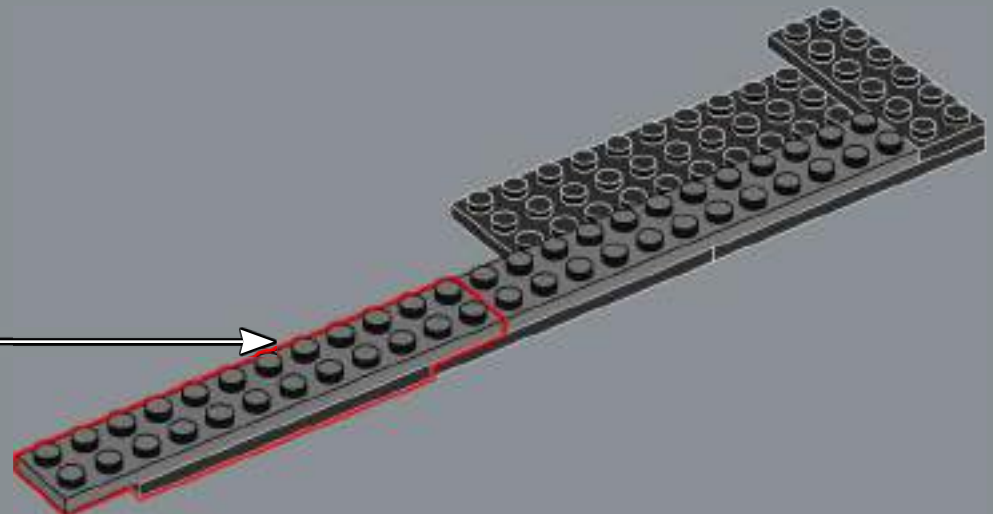
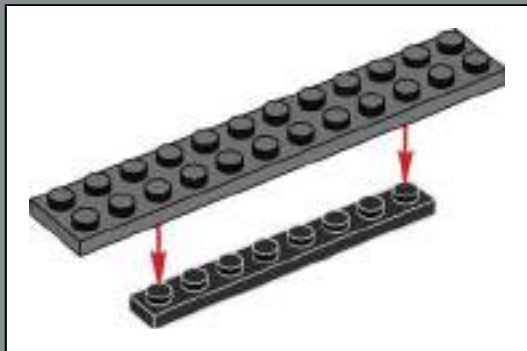

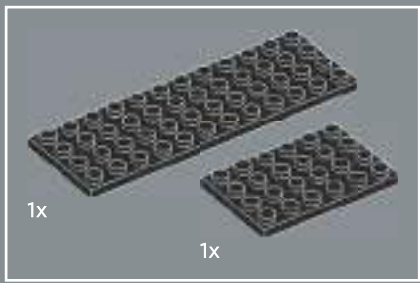

36

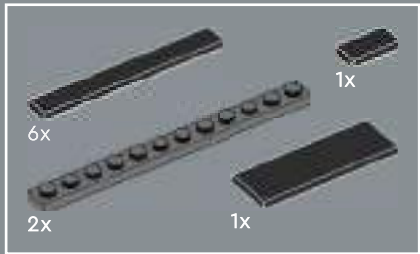
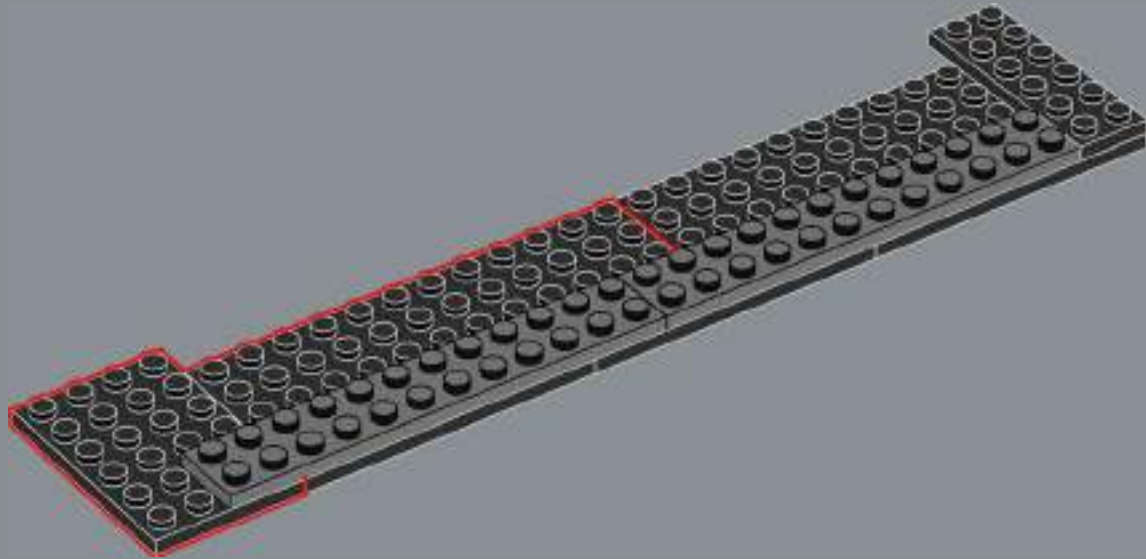

37

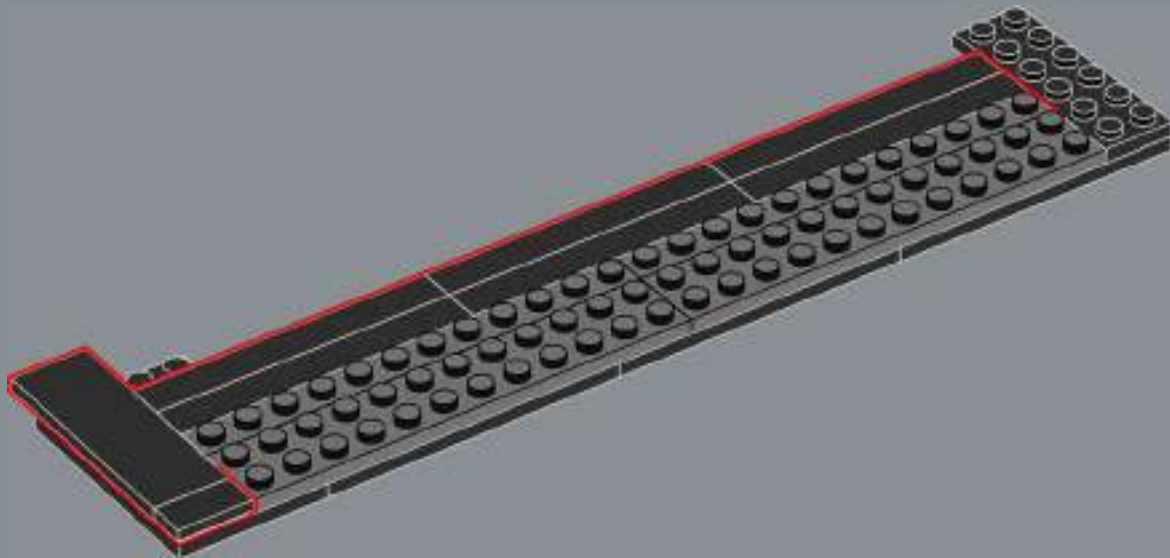

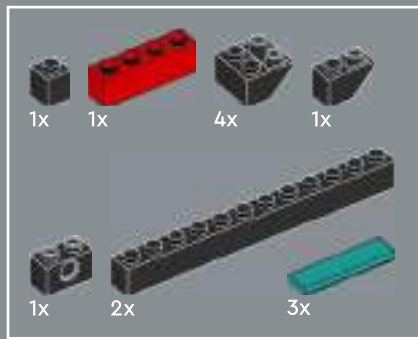

38

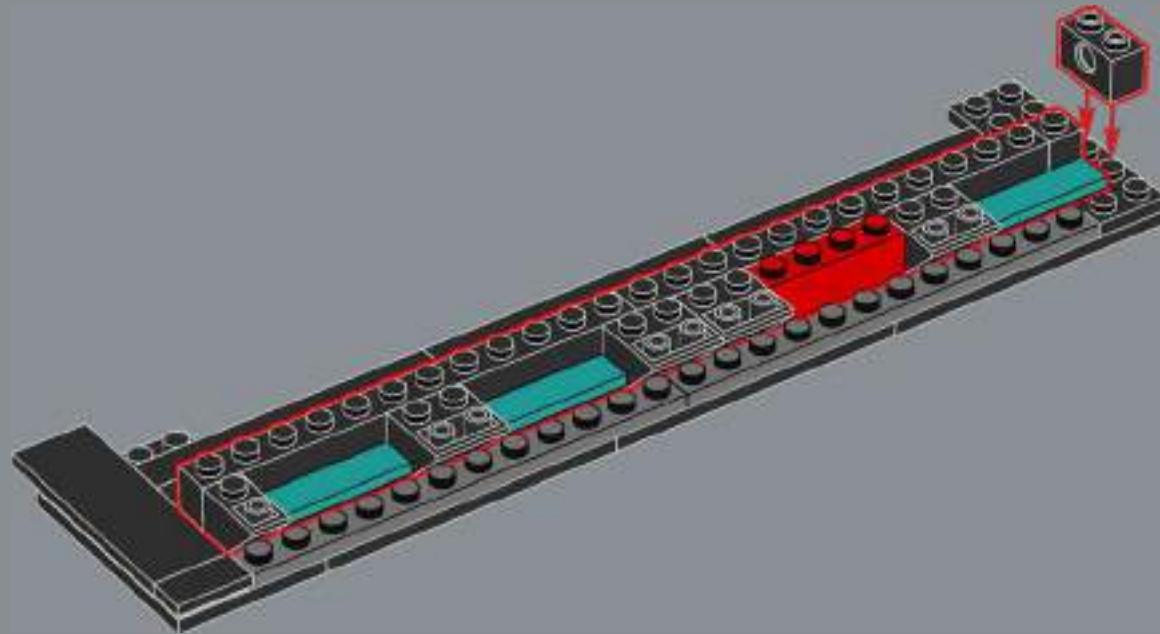

39

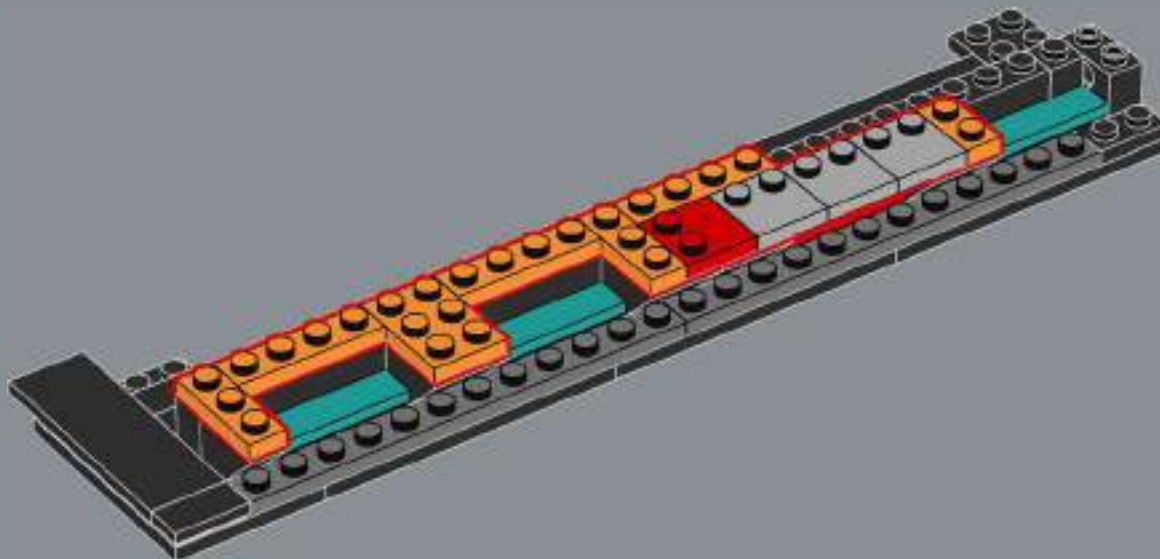

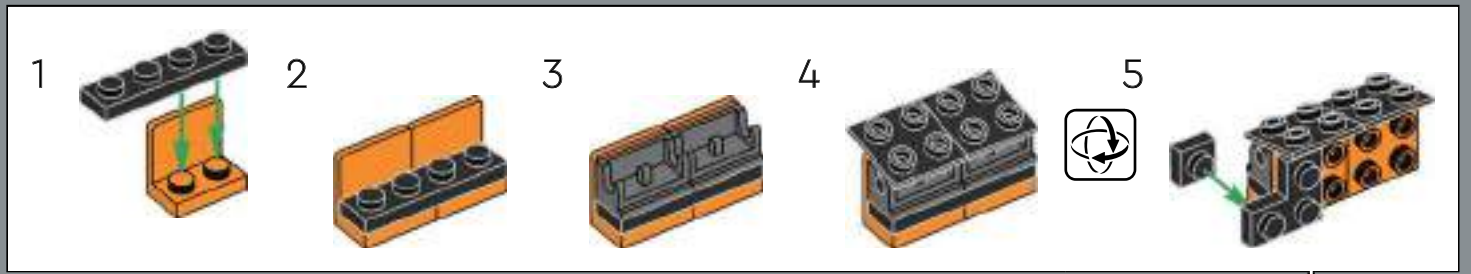

40

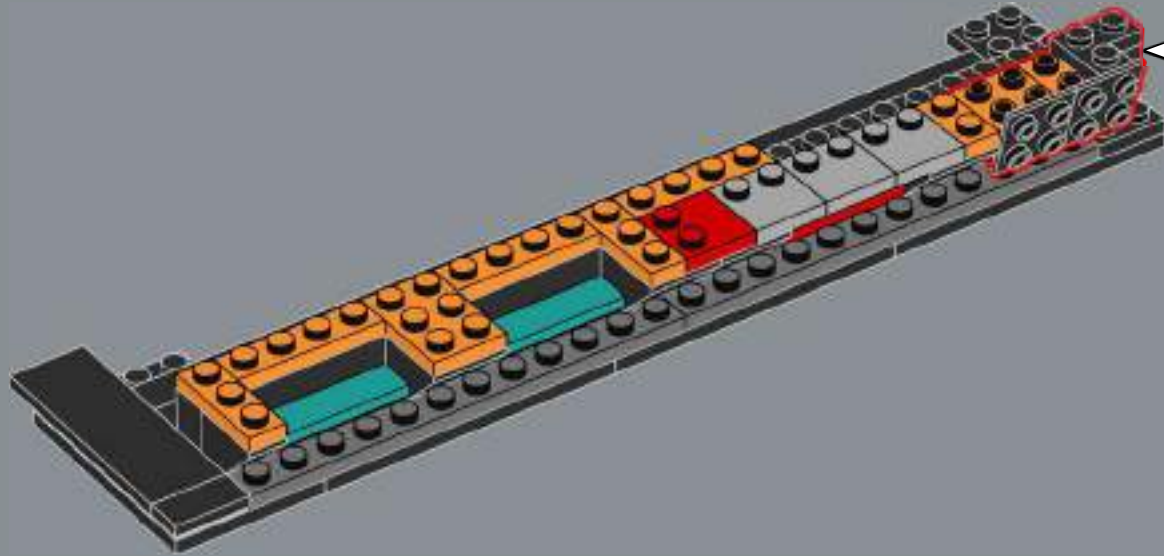

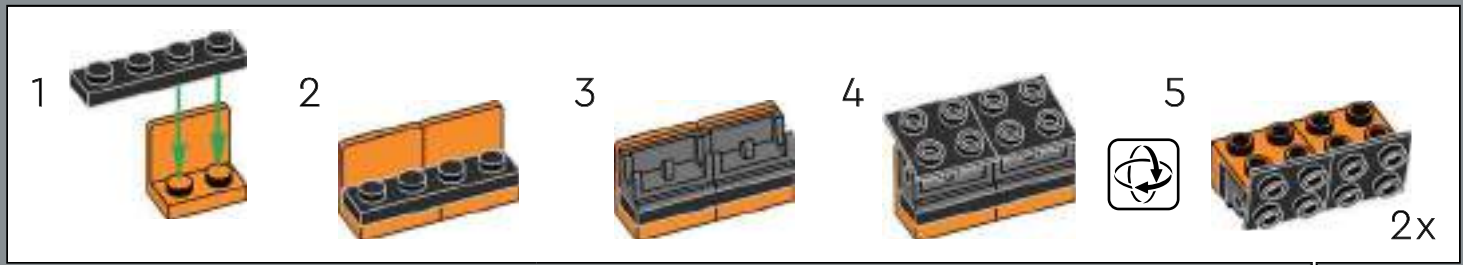
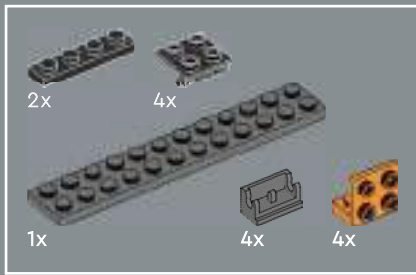

41

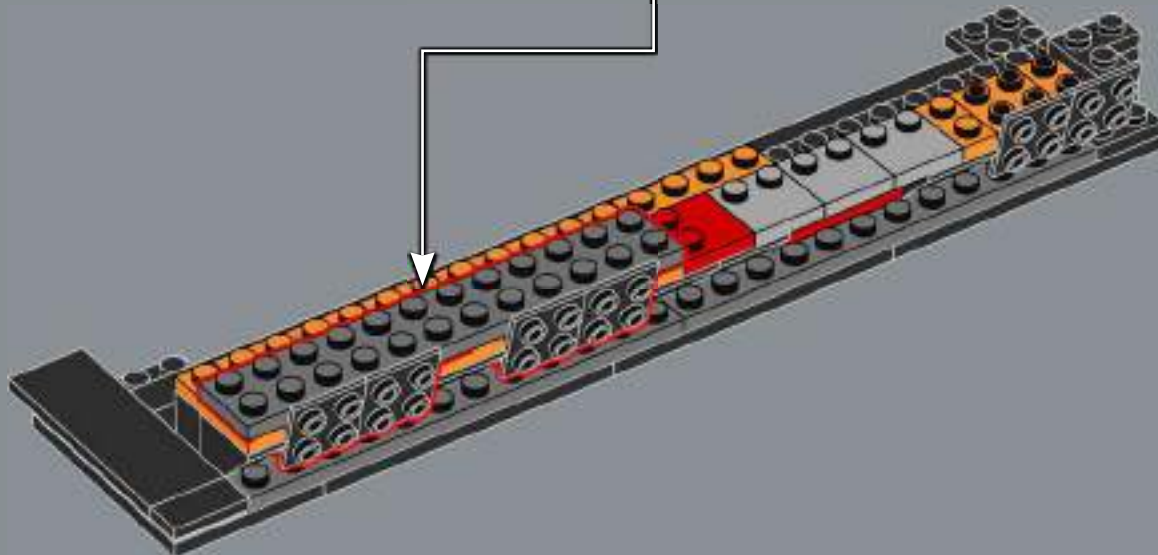
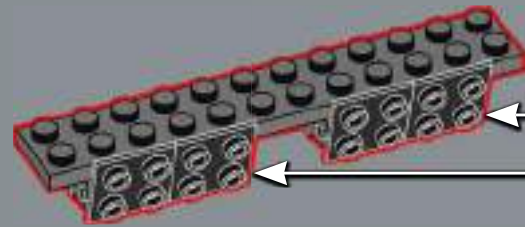

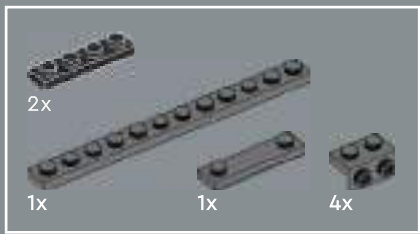

42

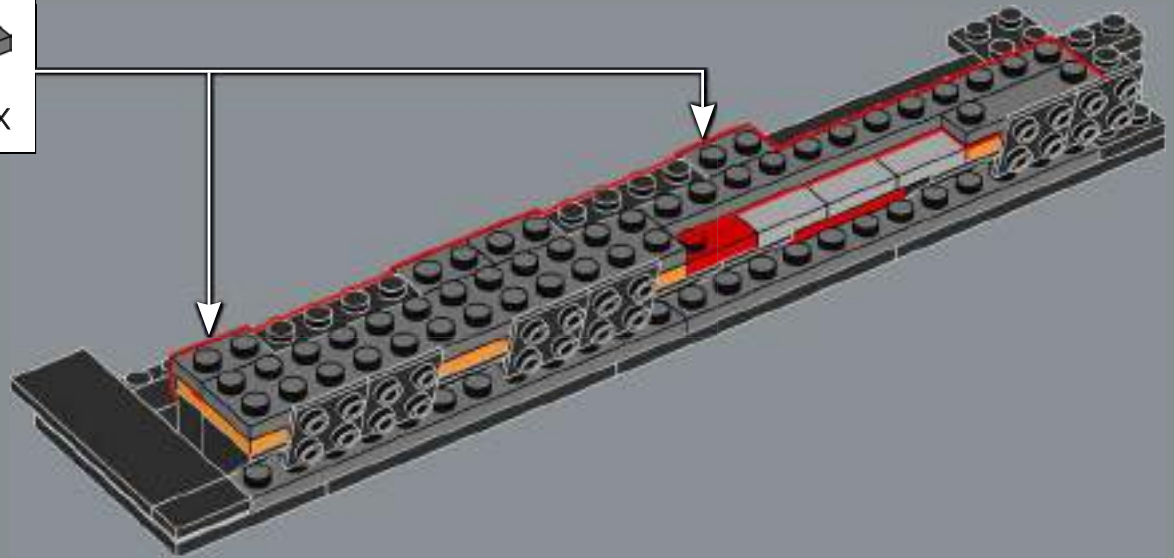
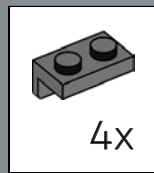

43

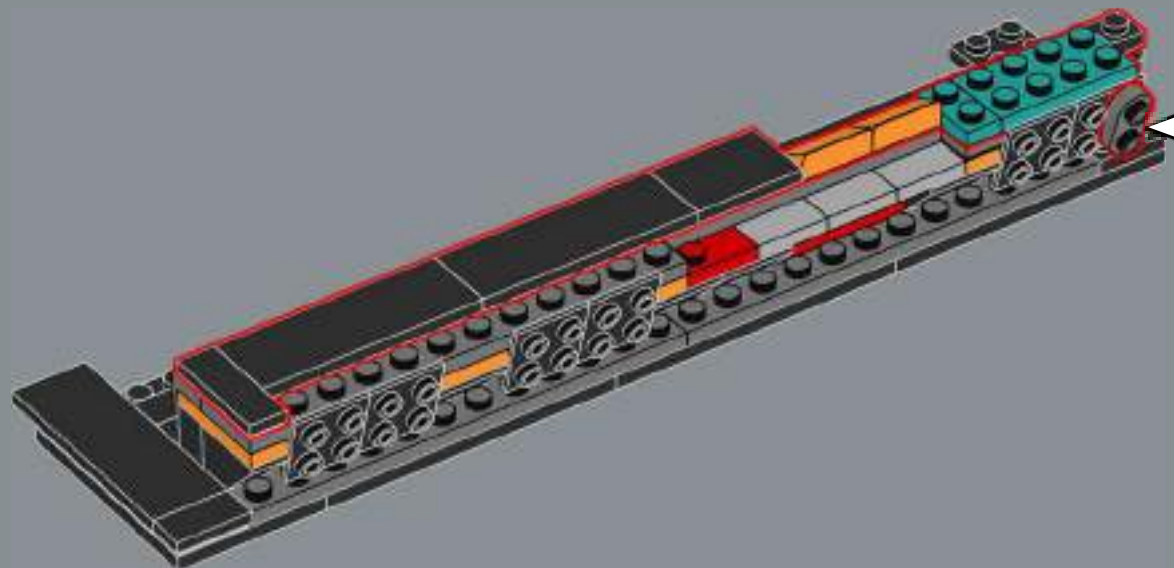

44

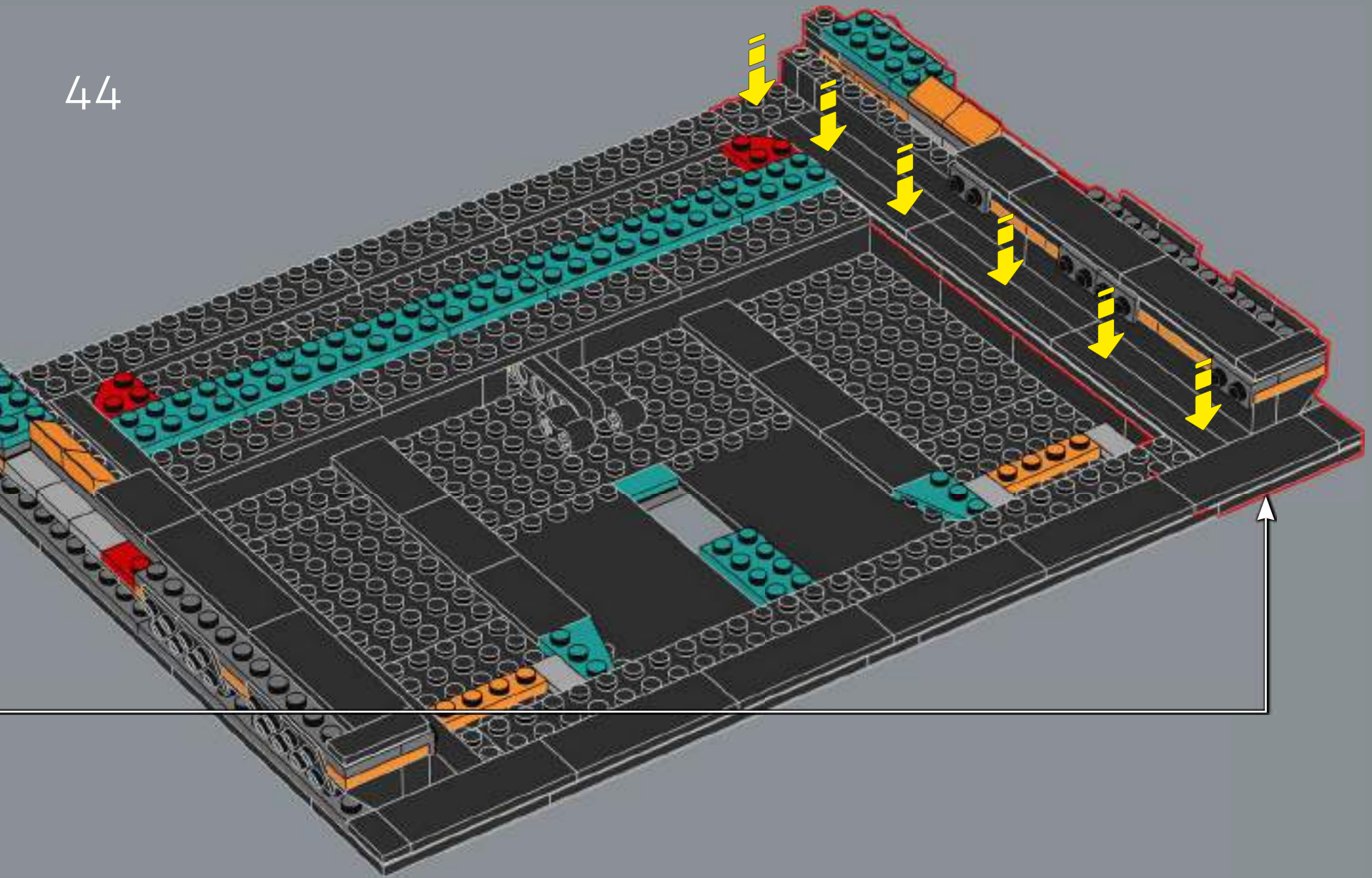



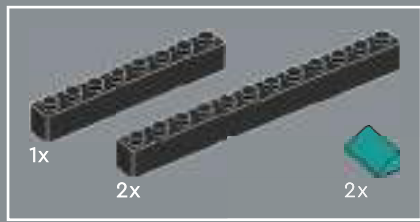

45

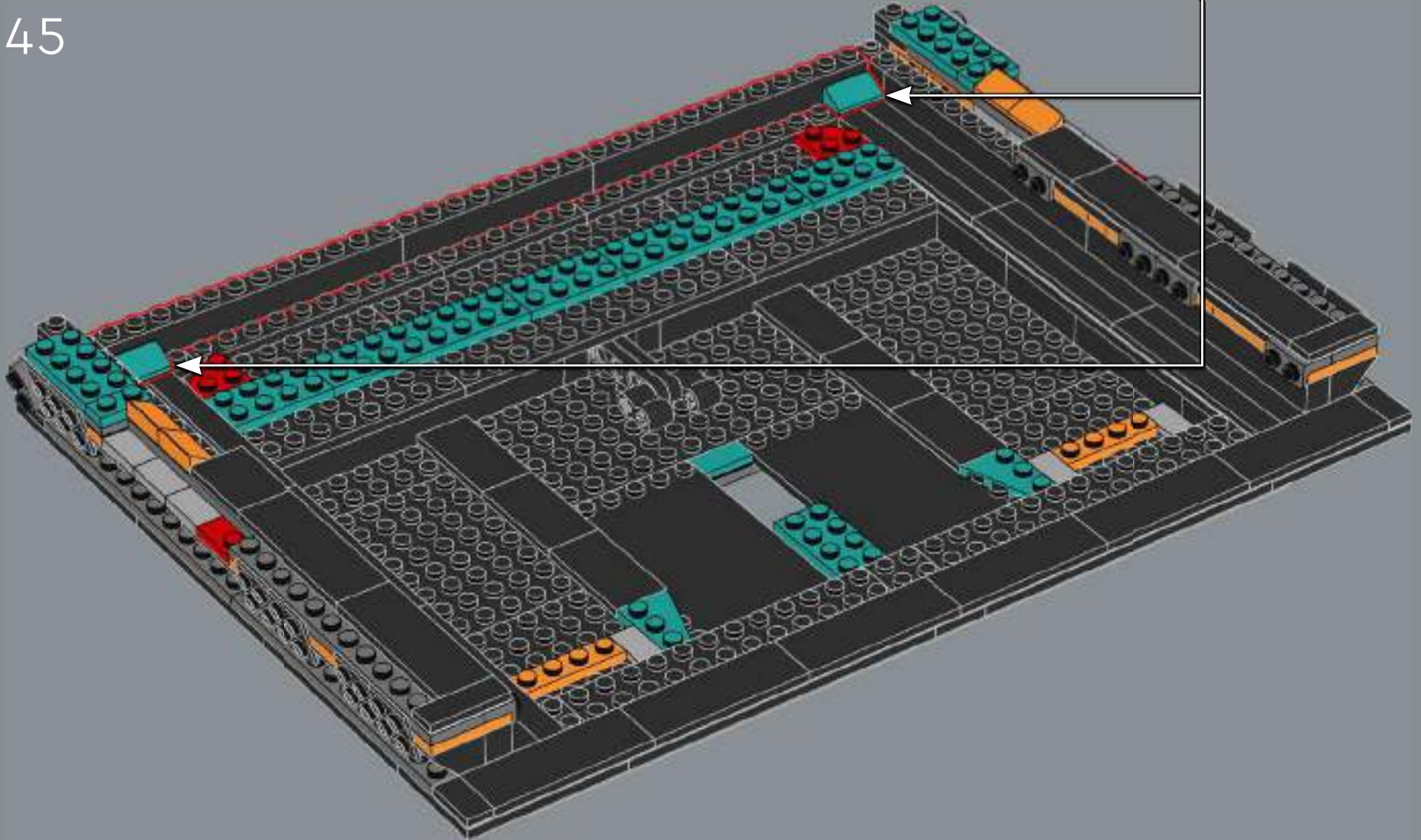

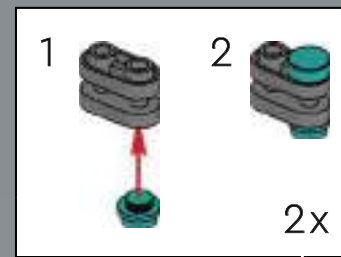
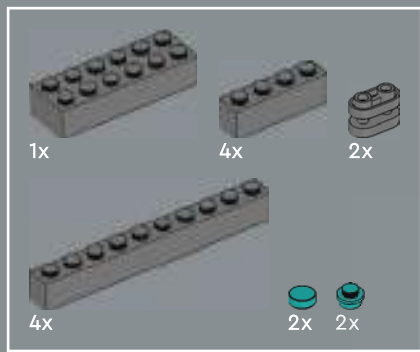

46

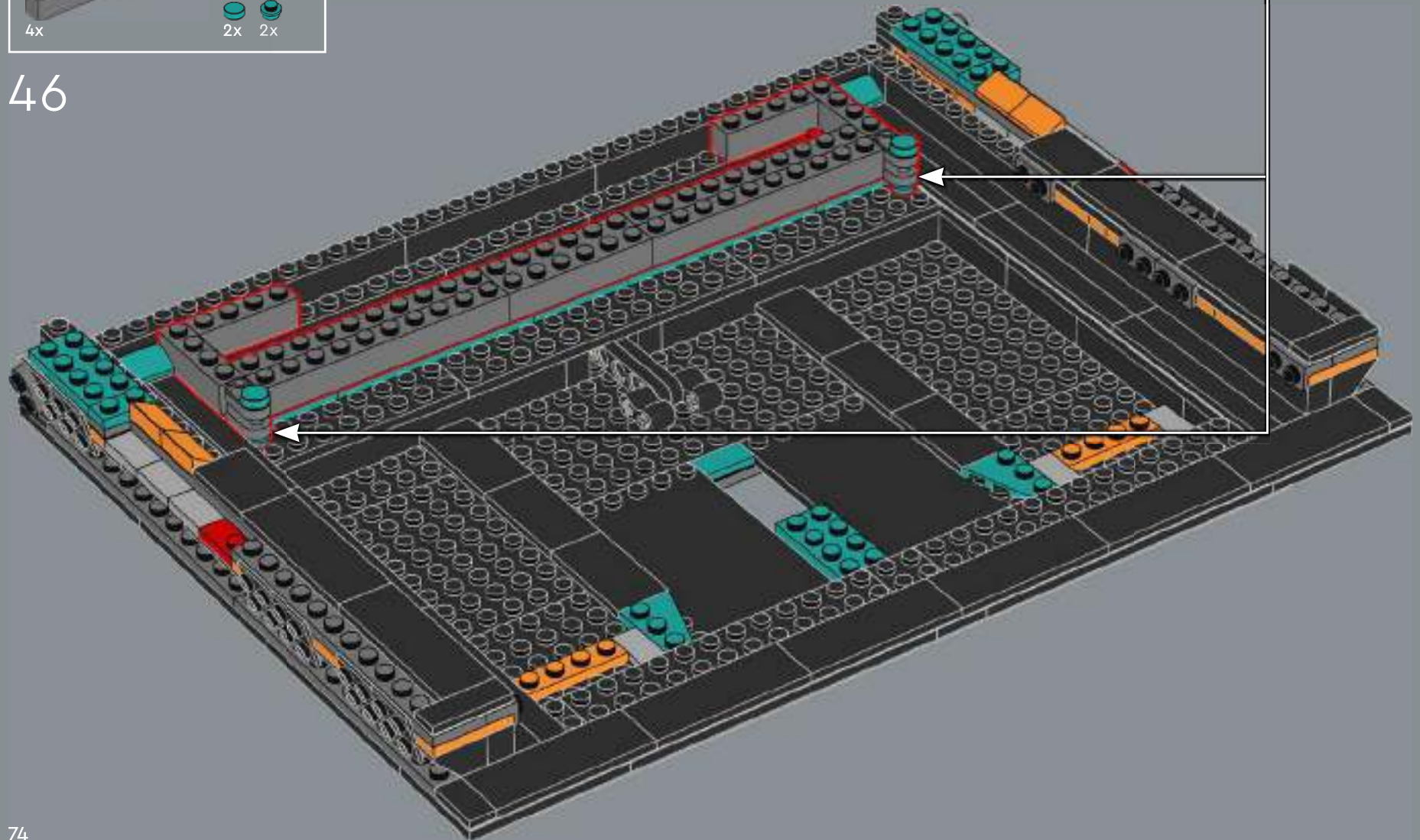

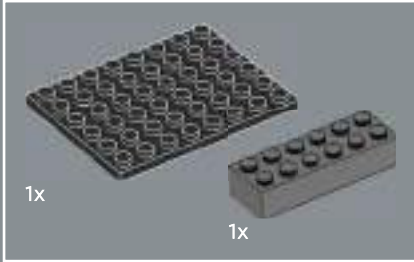

47

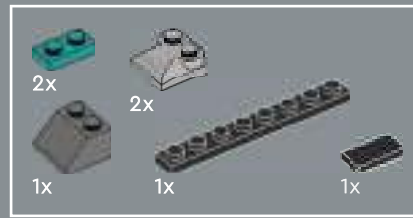
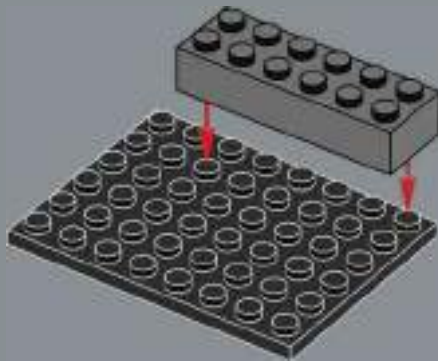

48

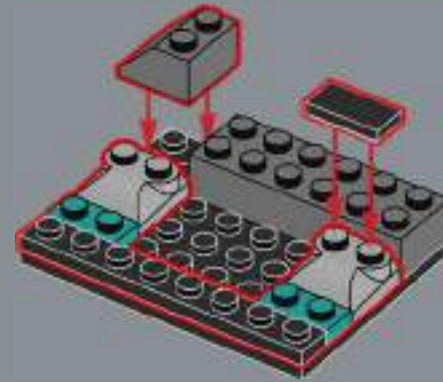

49

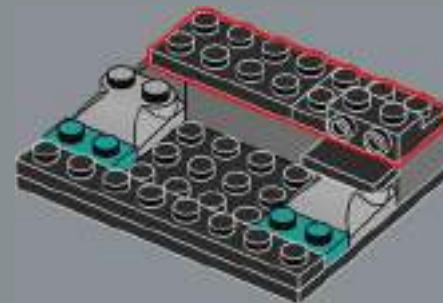



50

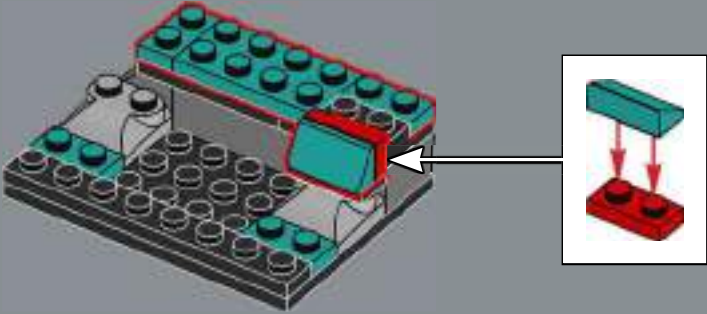

51

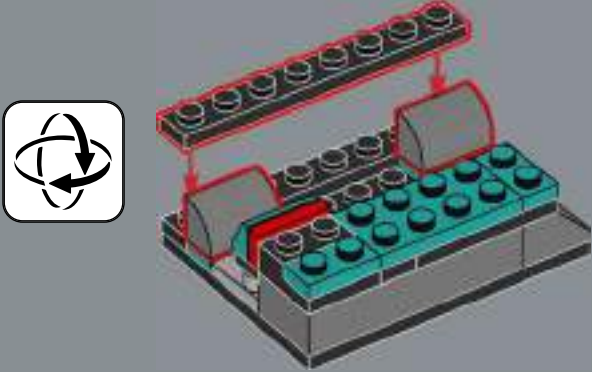

52

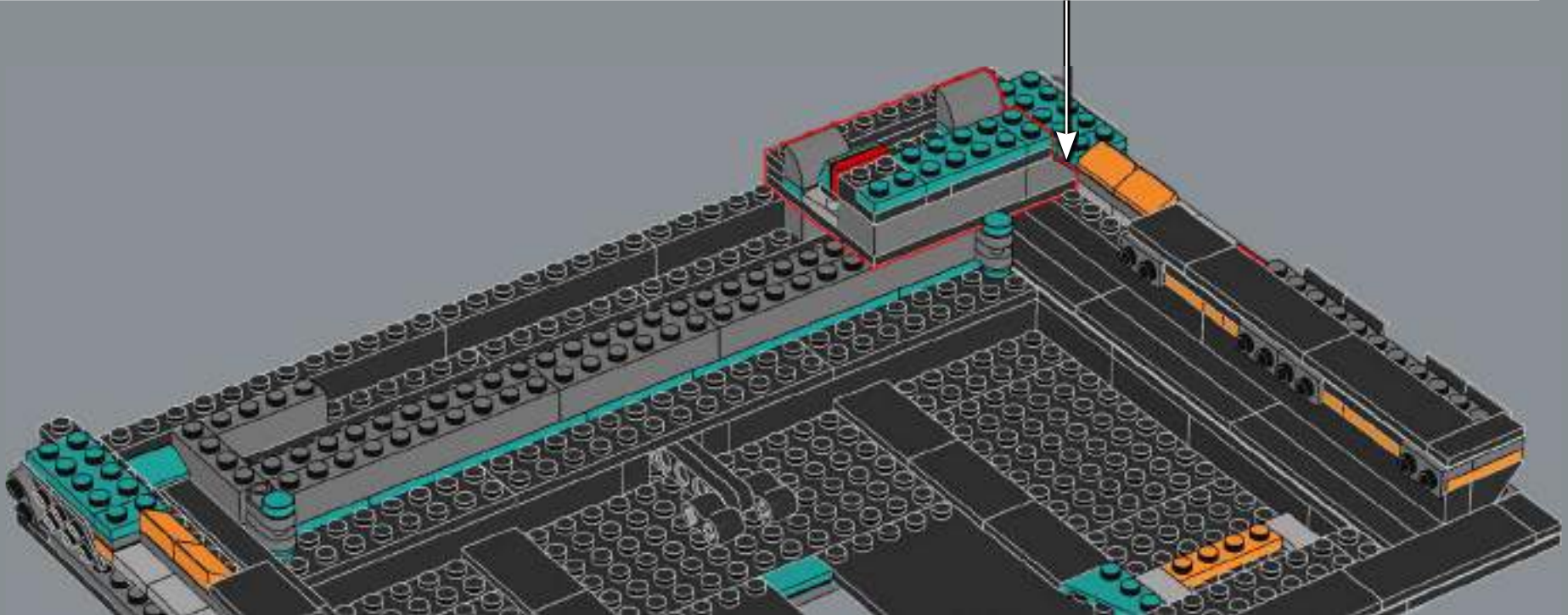

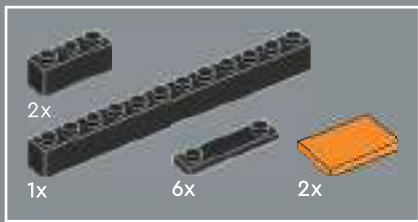

53

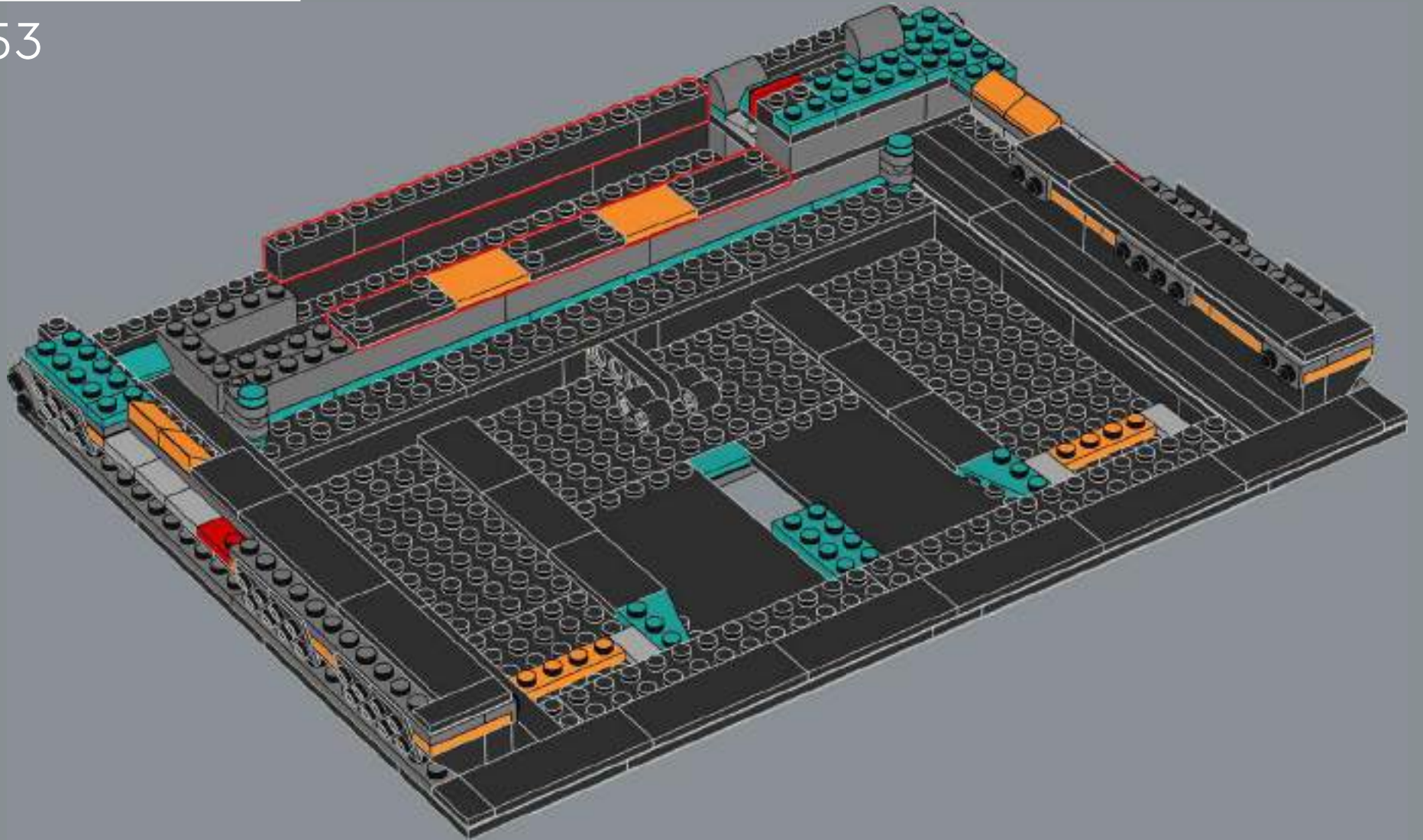

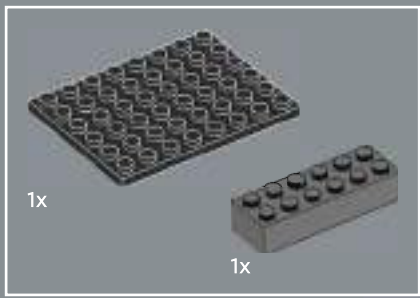

54

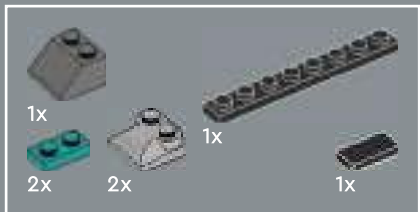
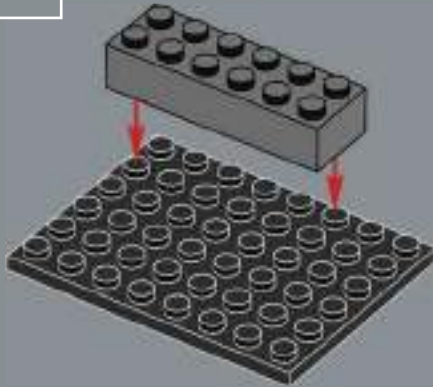

55

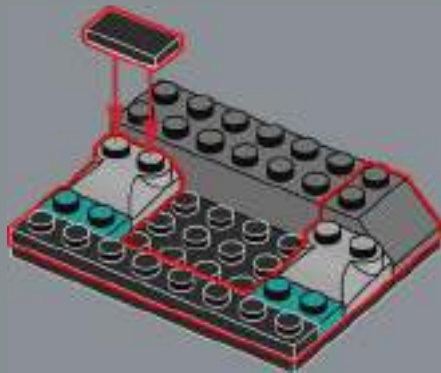

56

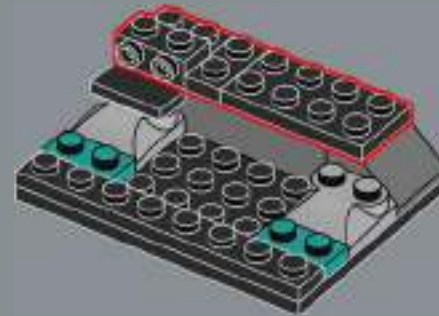

57

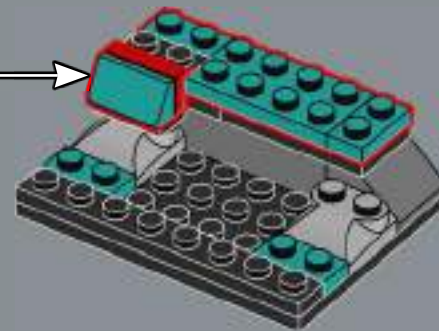



58

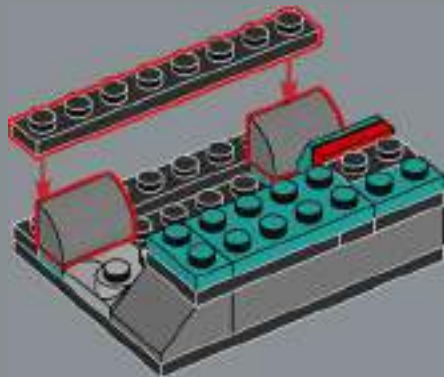

59

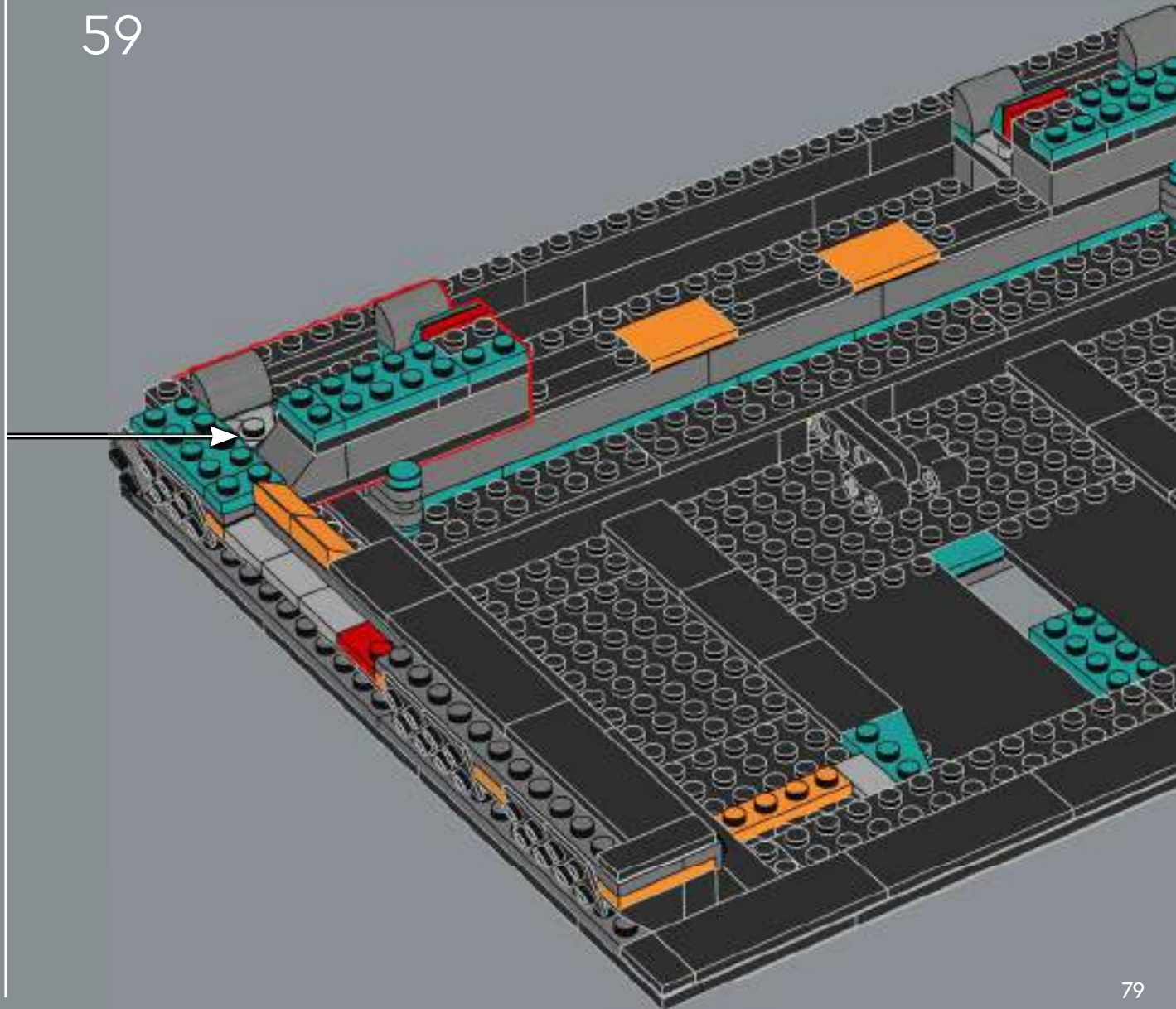

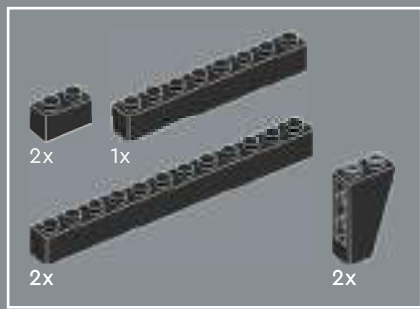

60

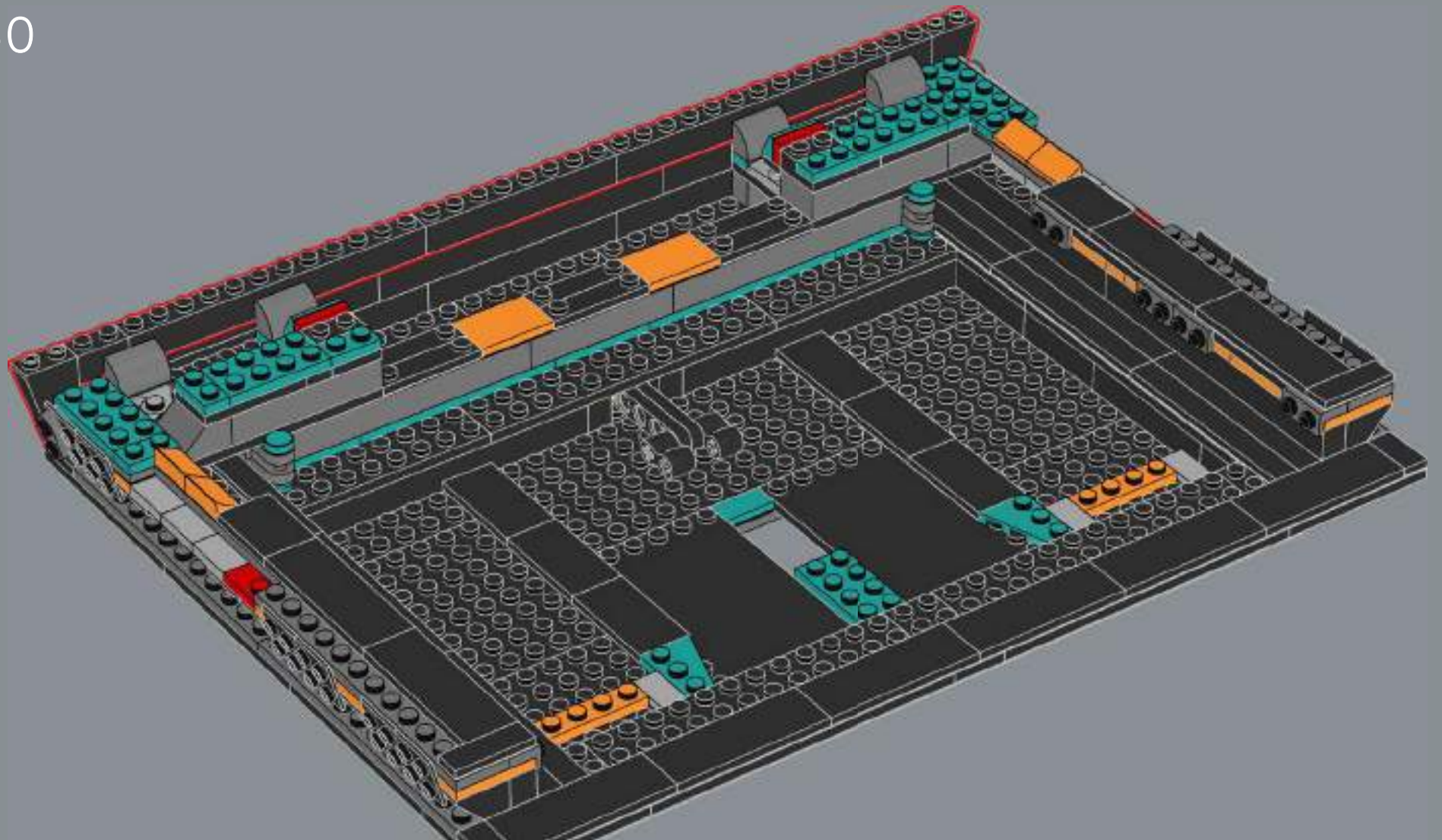

80

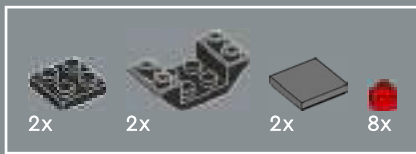

61

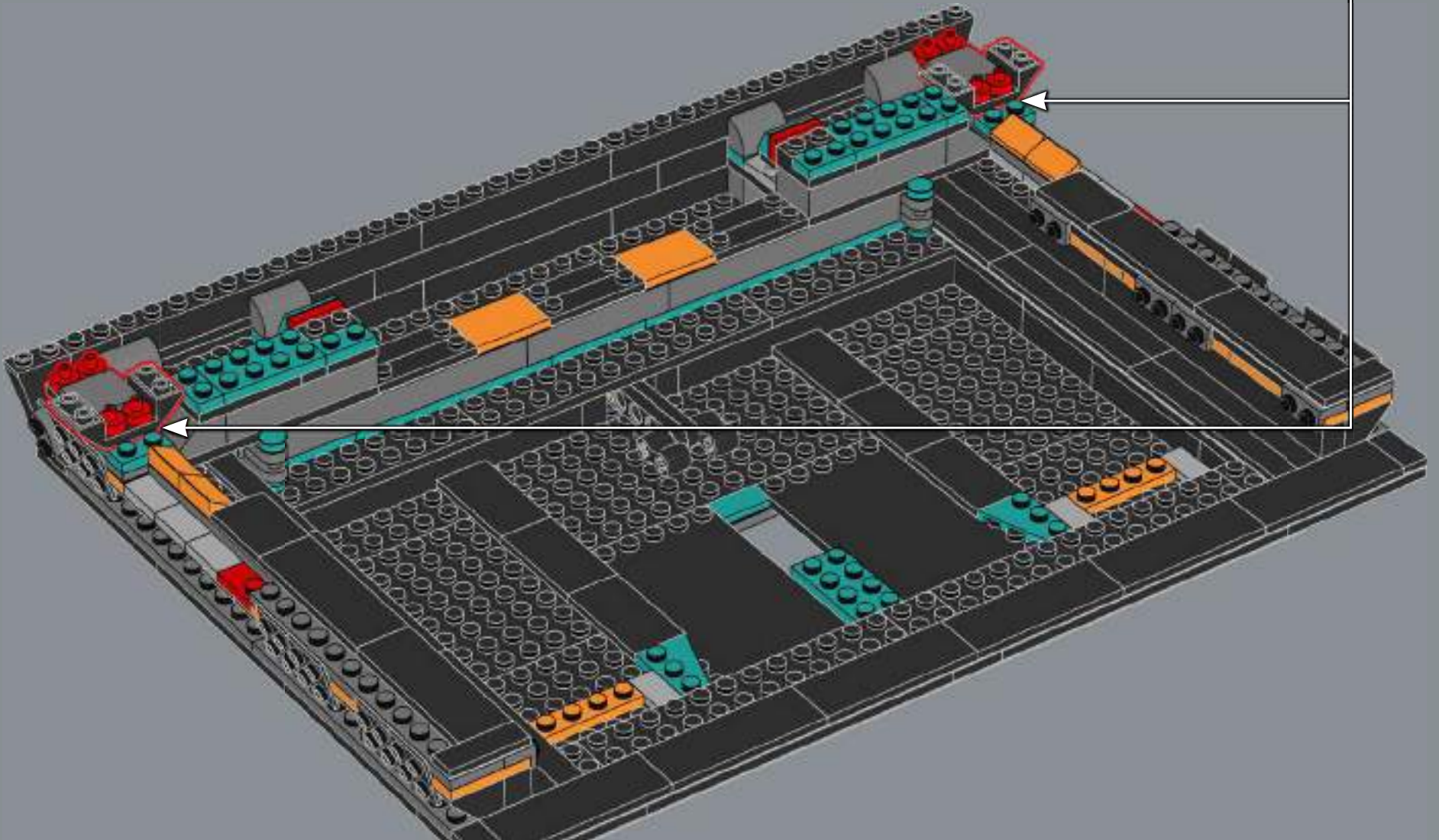
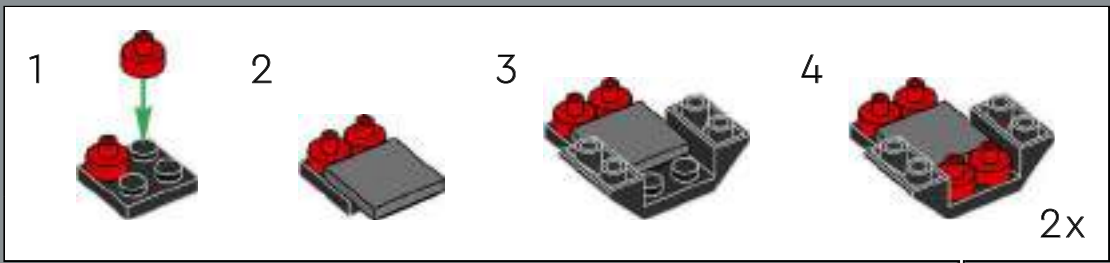

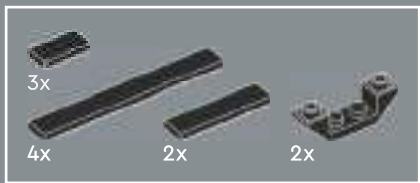

62

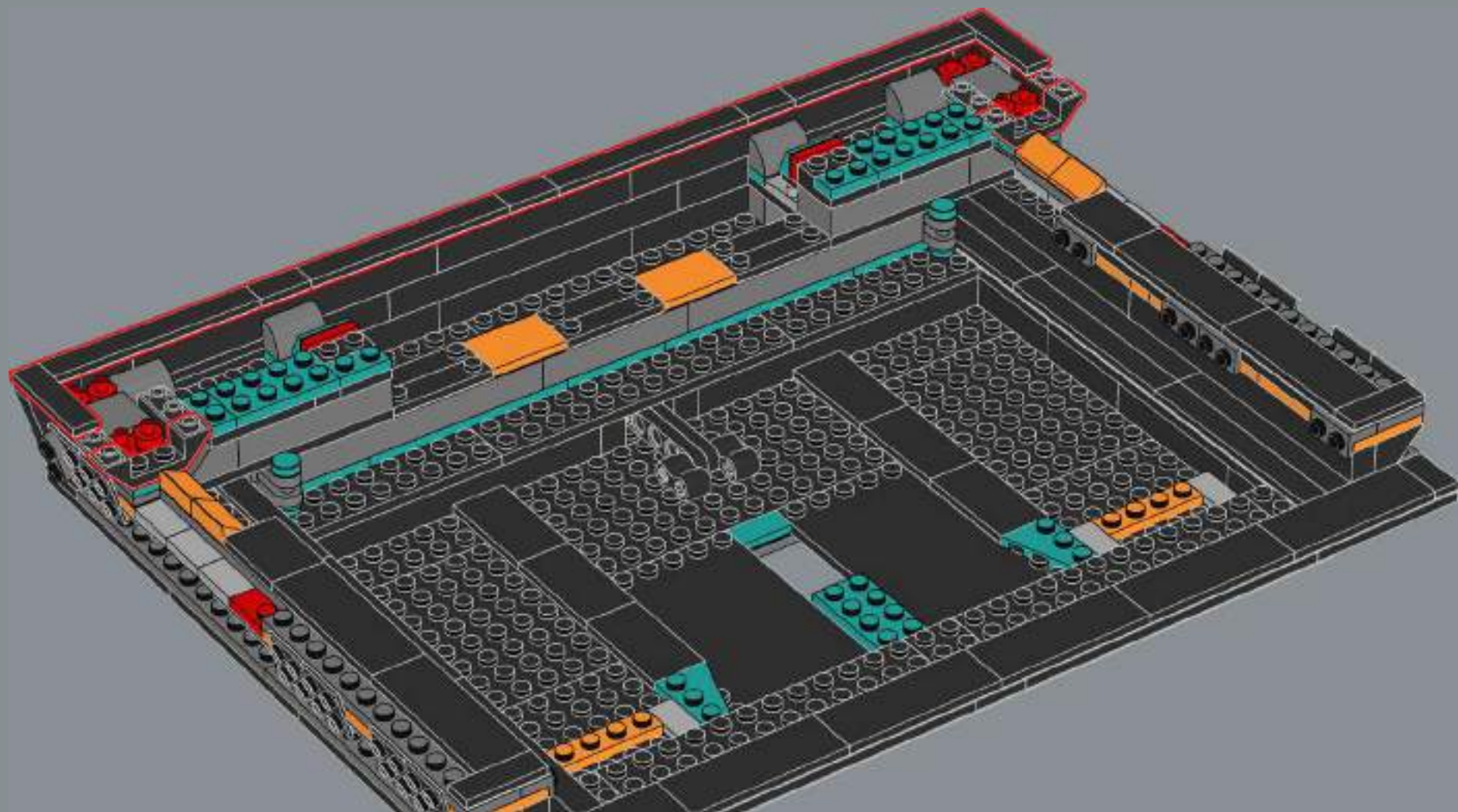

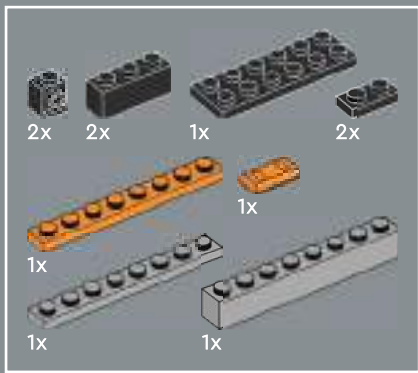

63

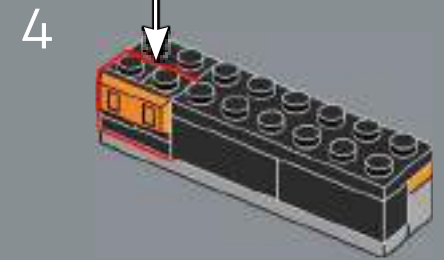
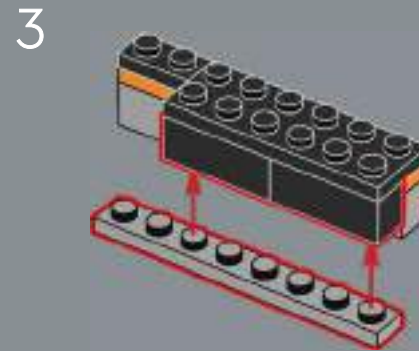
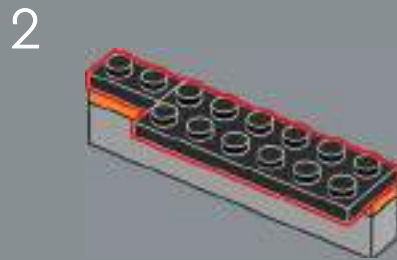
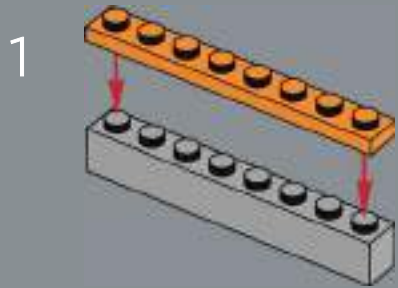
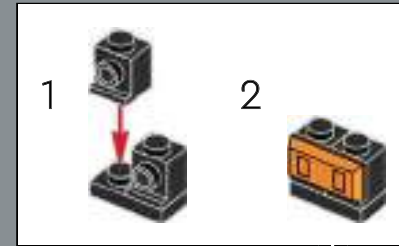

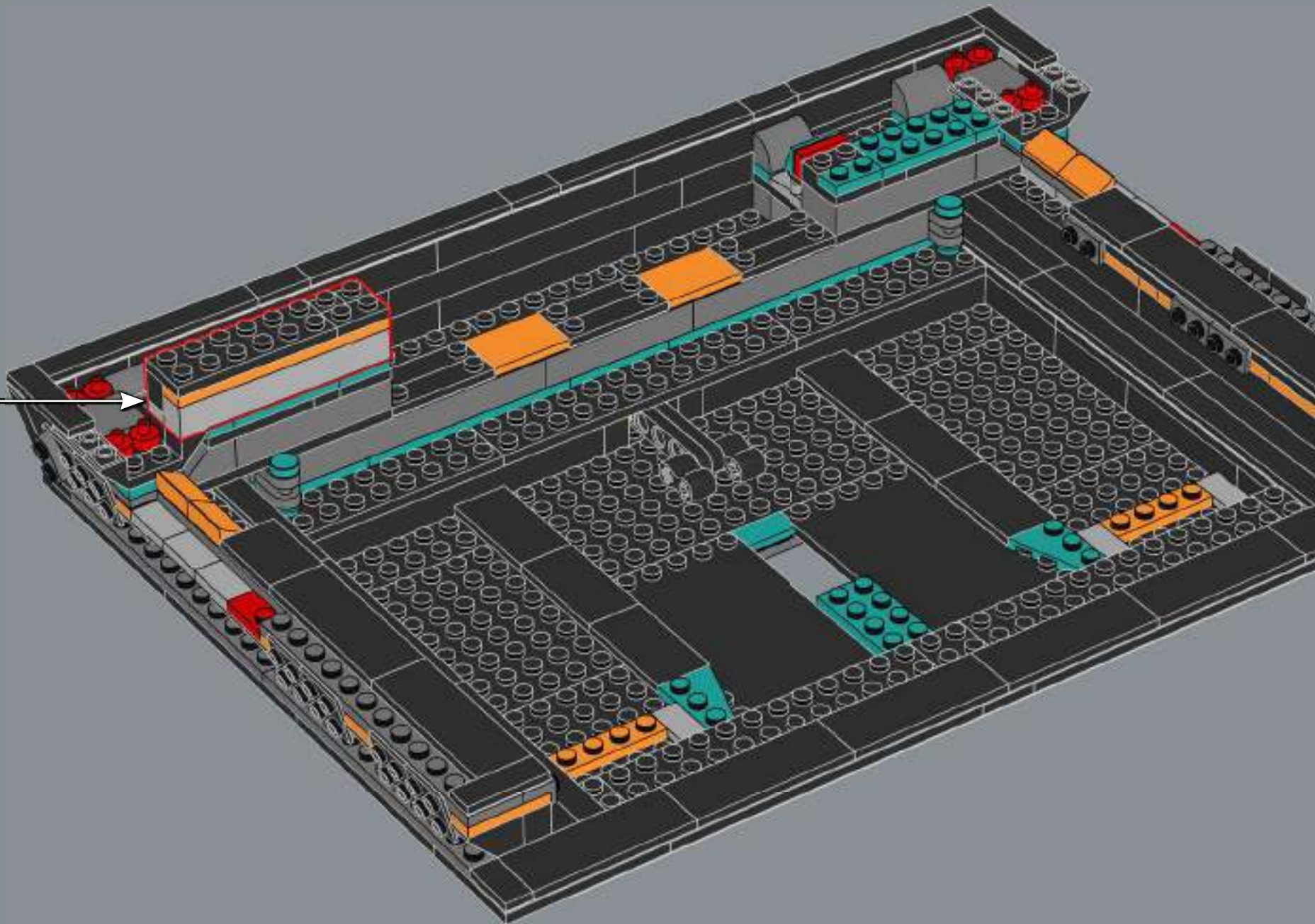

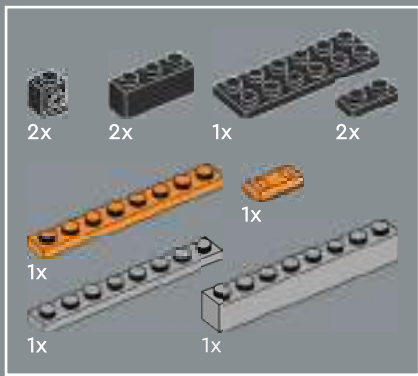

64

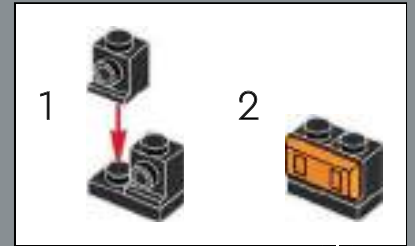
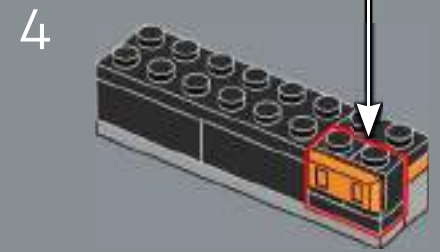
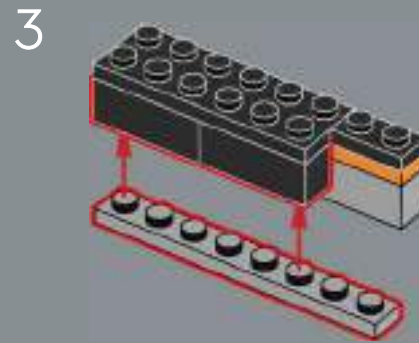
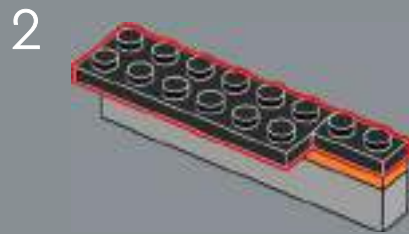
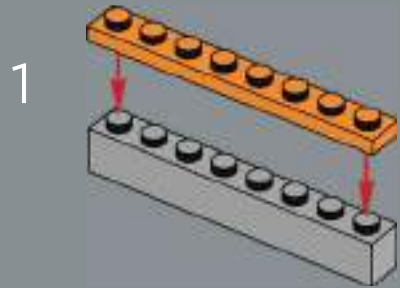

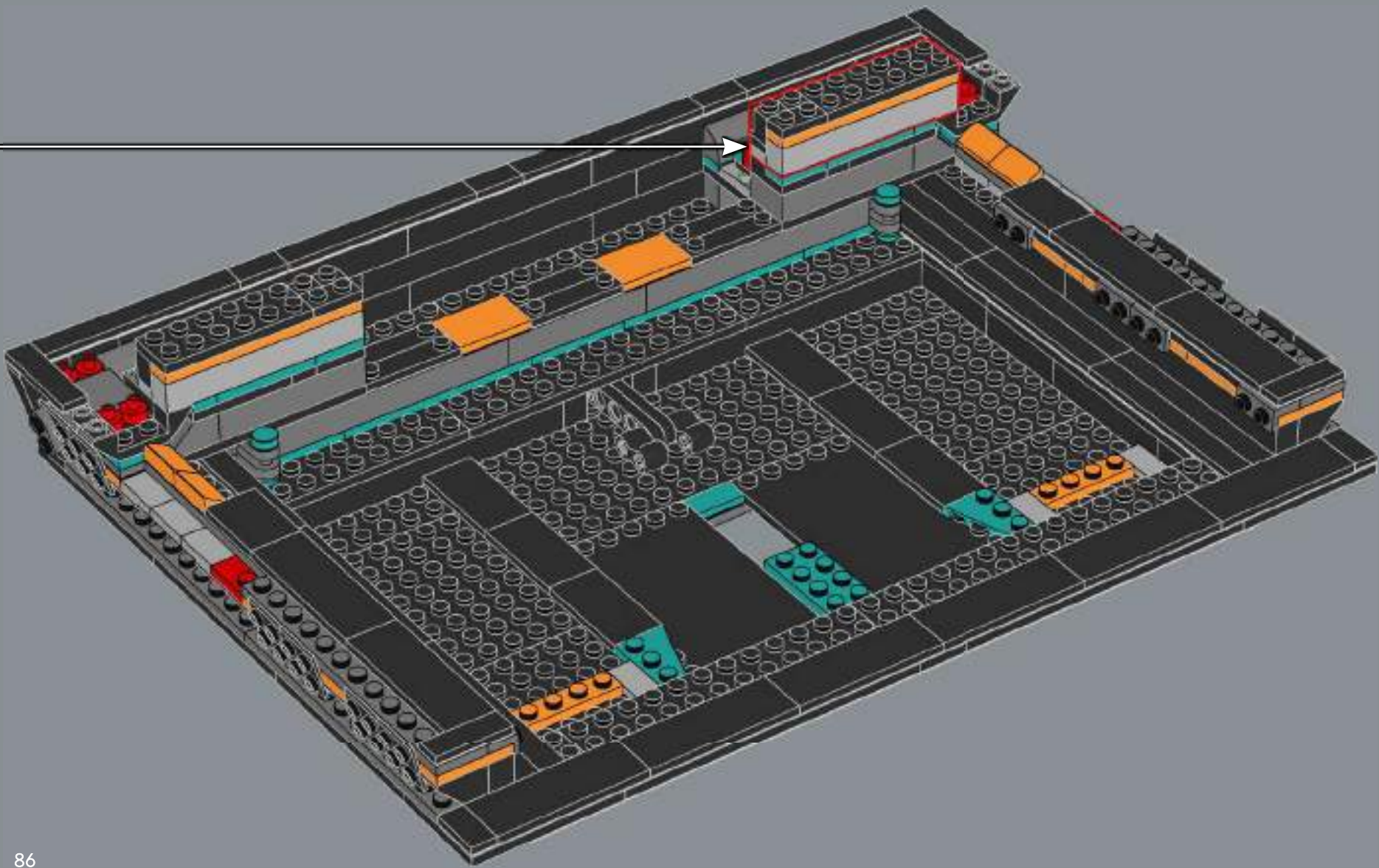

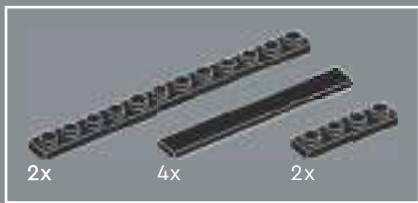

65

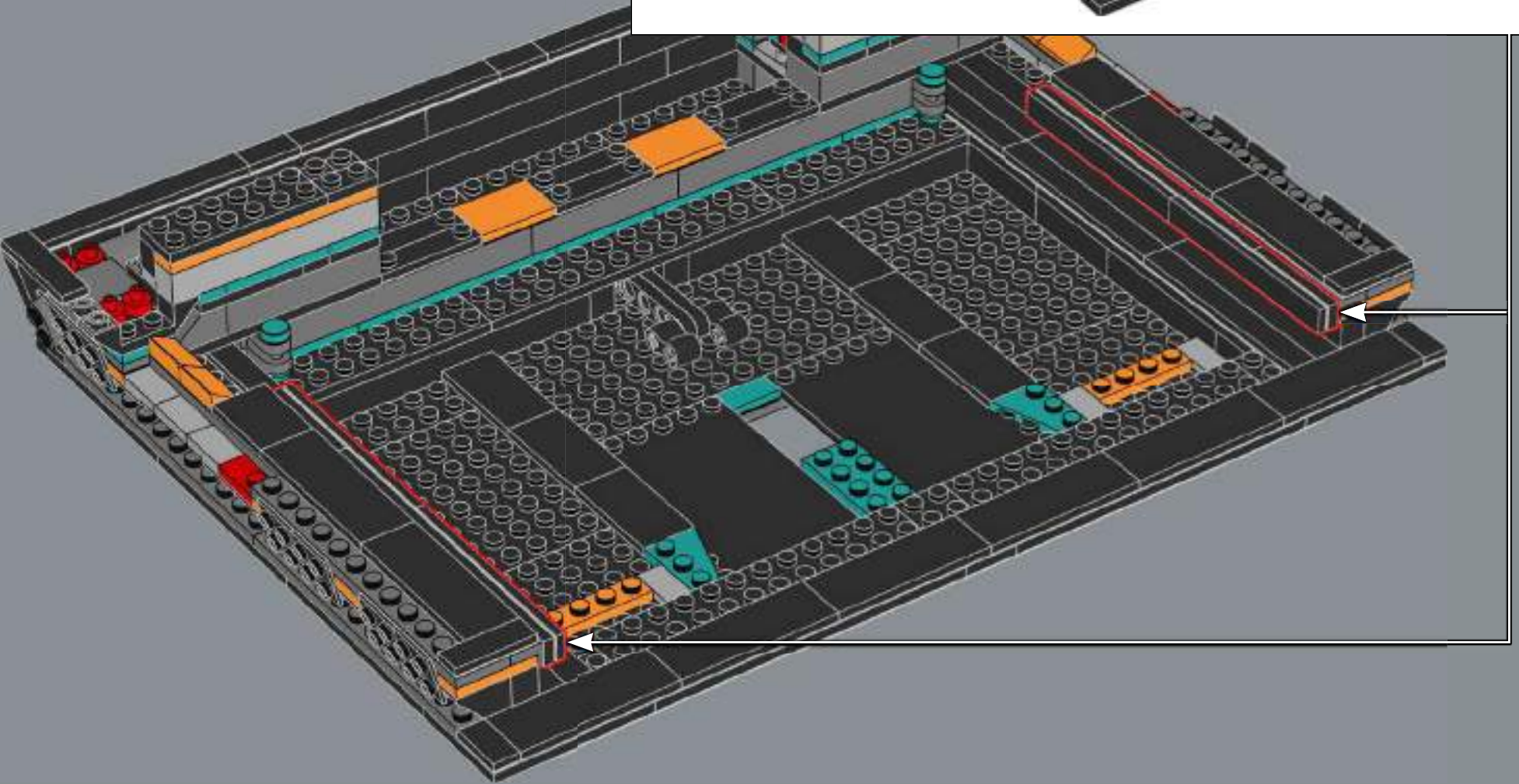
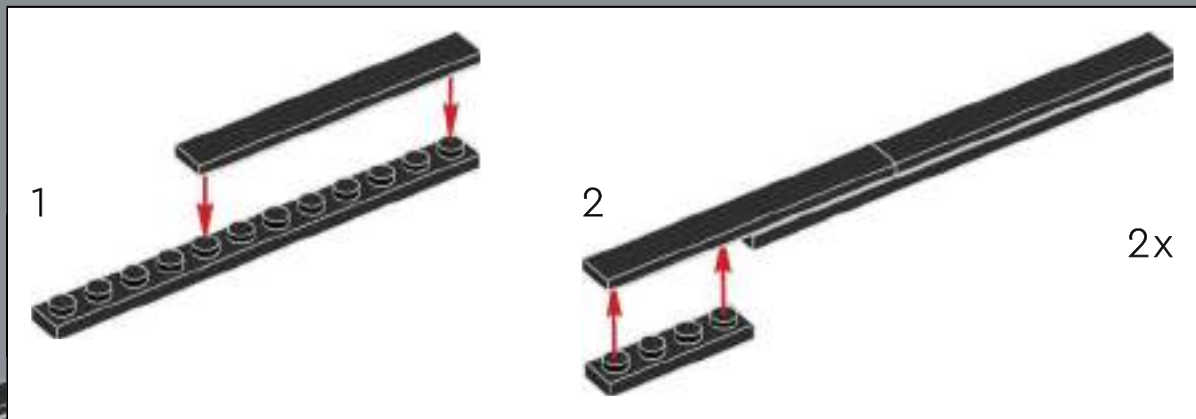

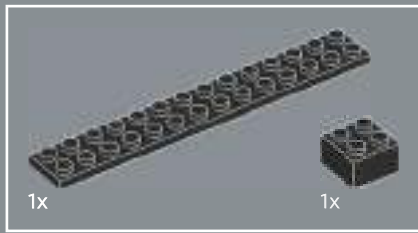

66

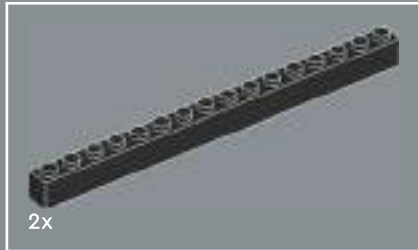
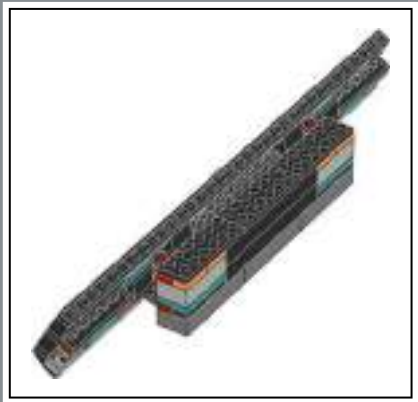
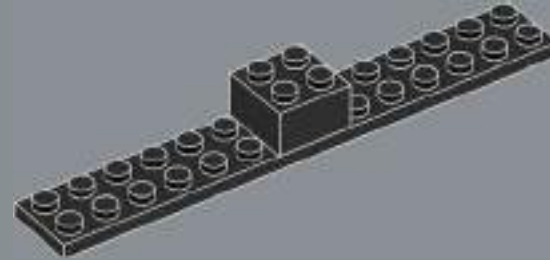

67

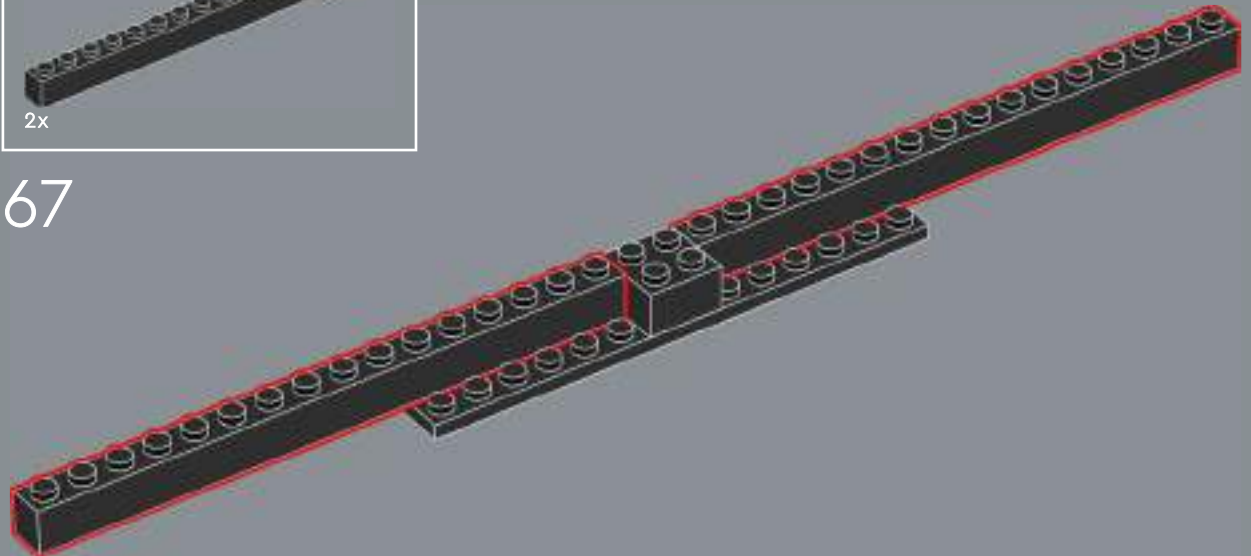



68

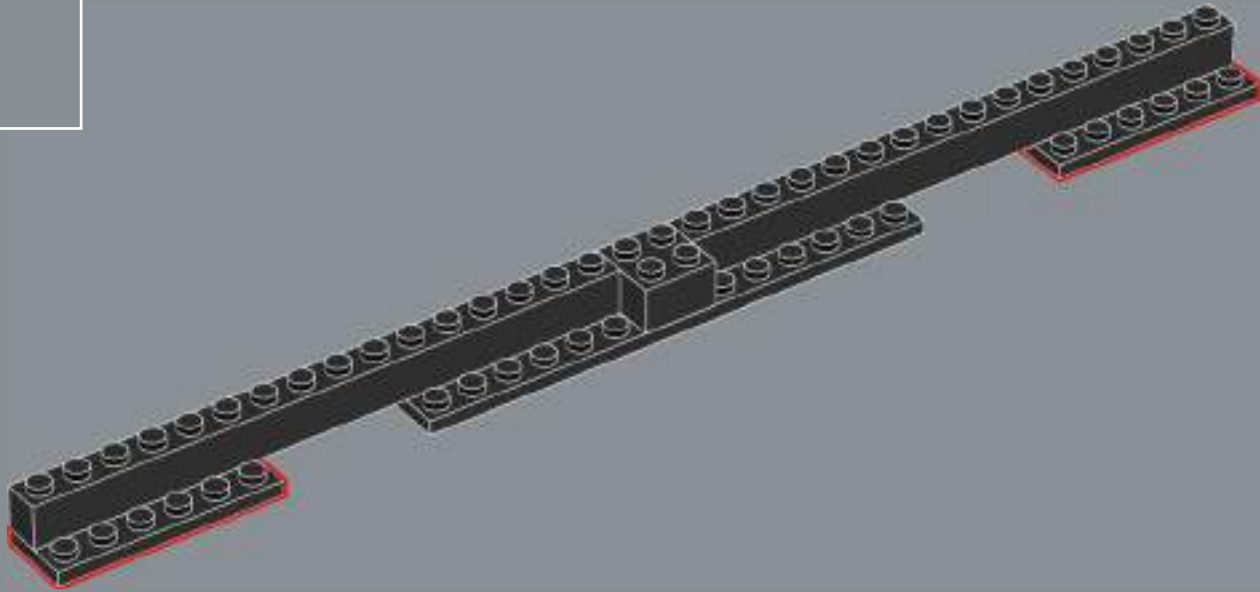

69

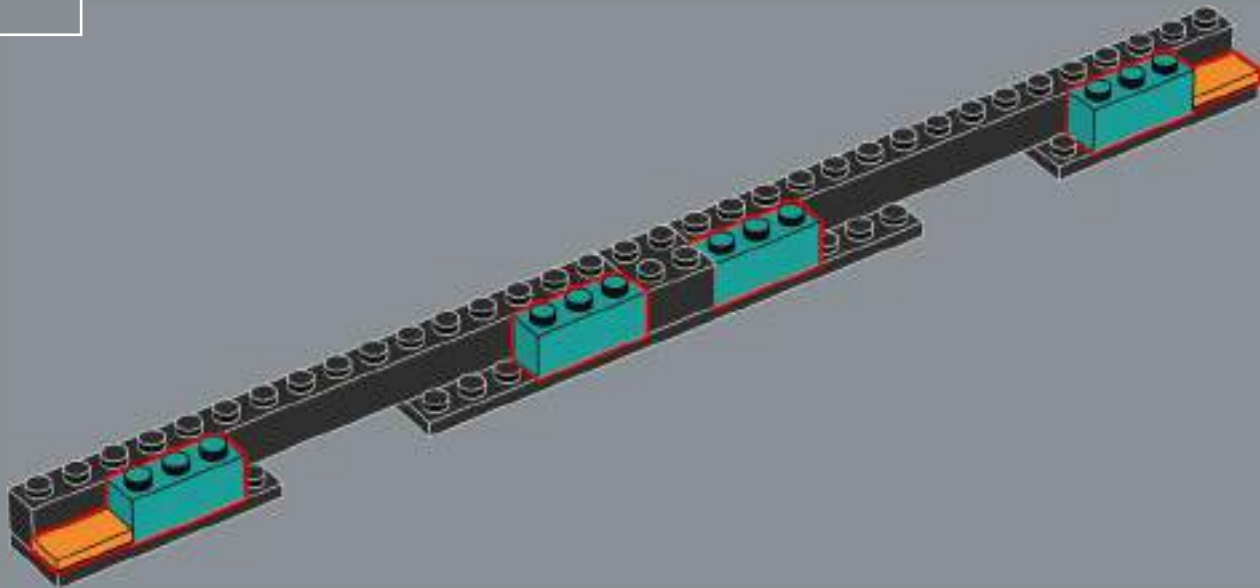

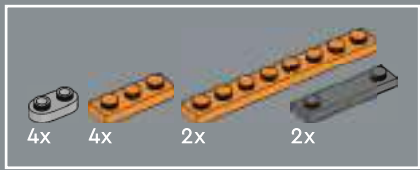

70

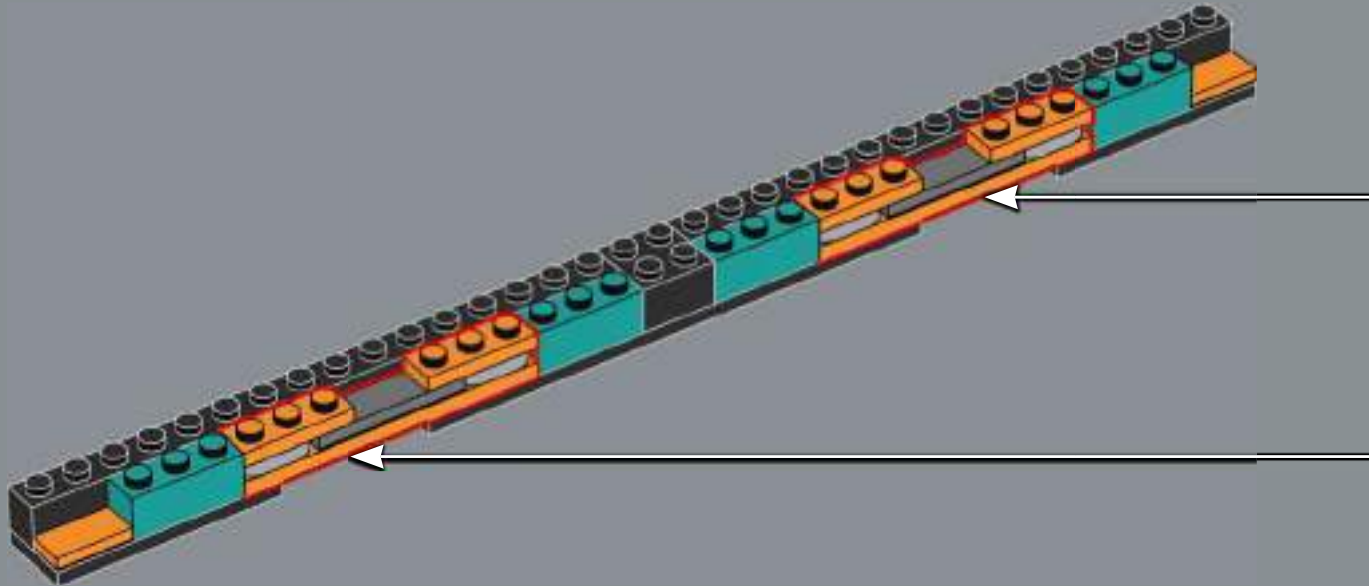
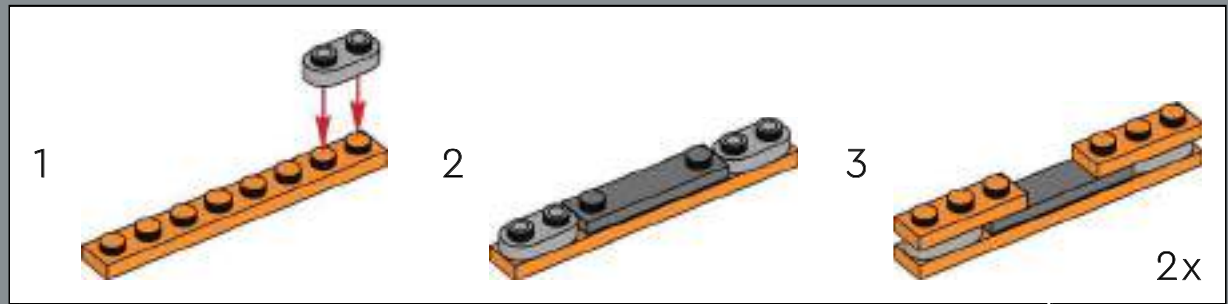

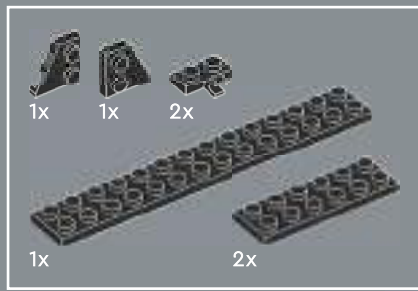

71

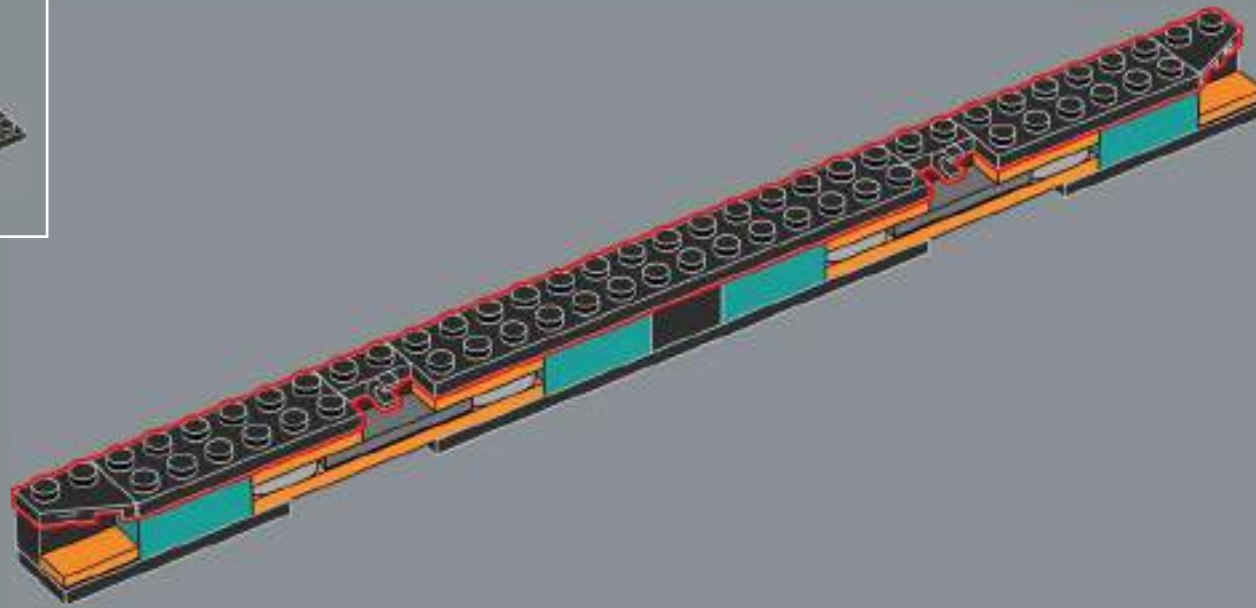

72

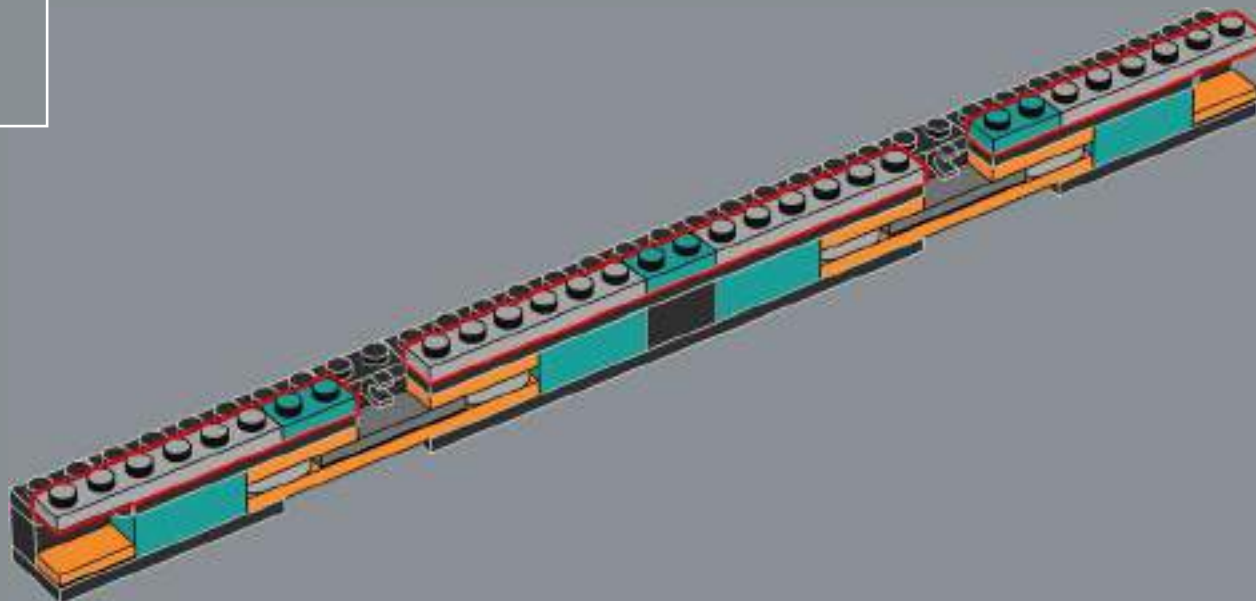



73

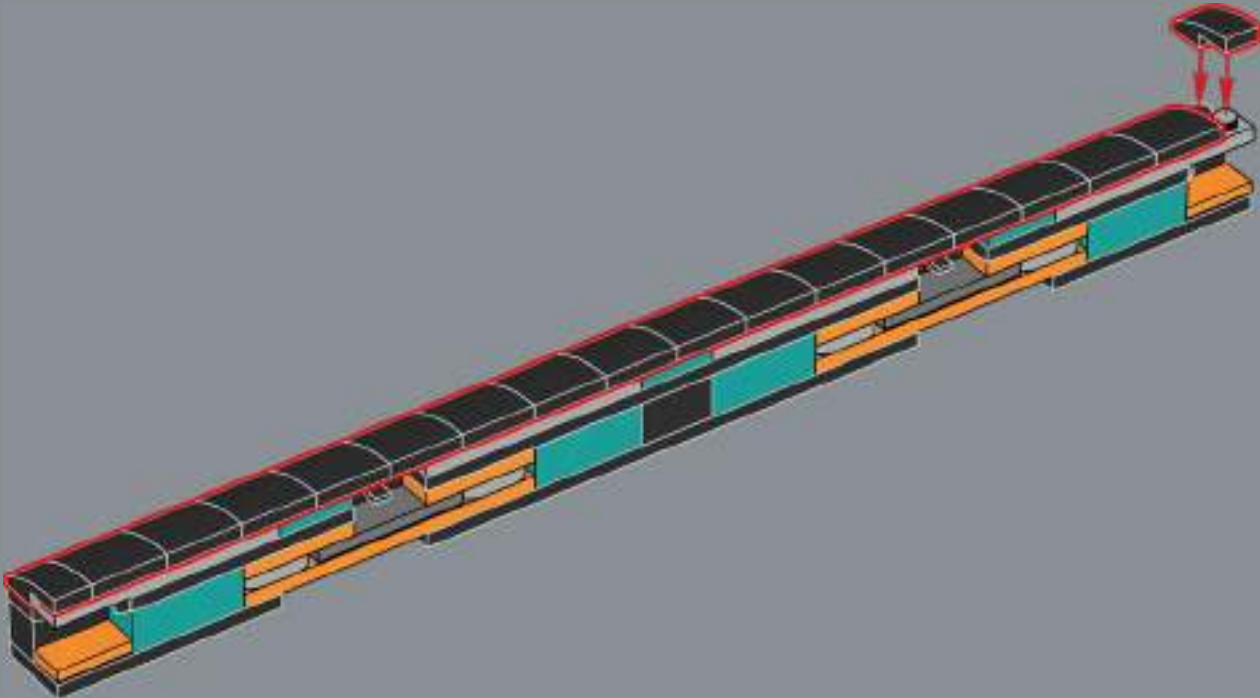

74

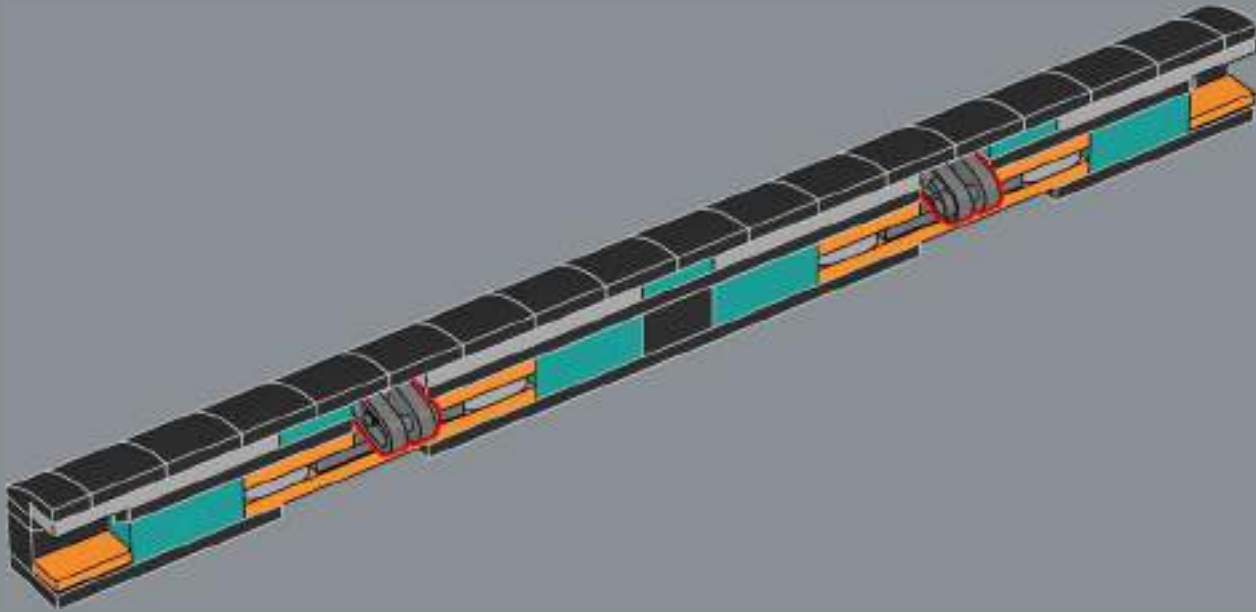



75

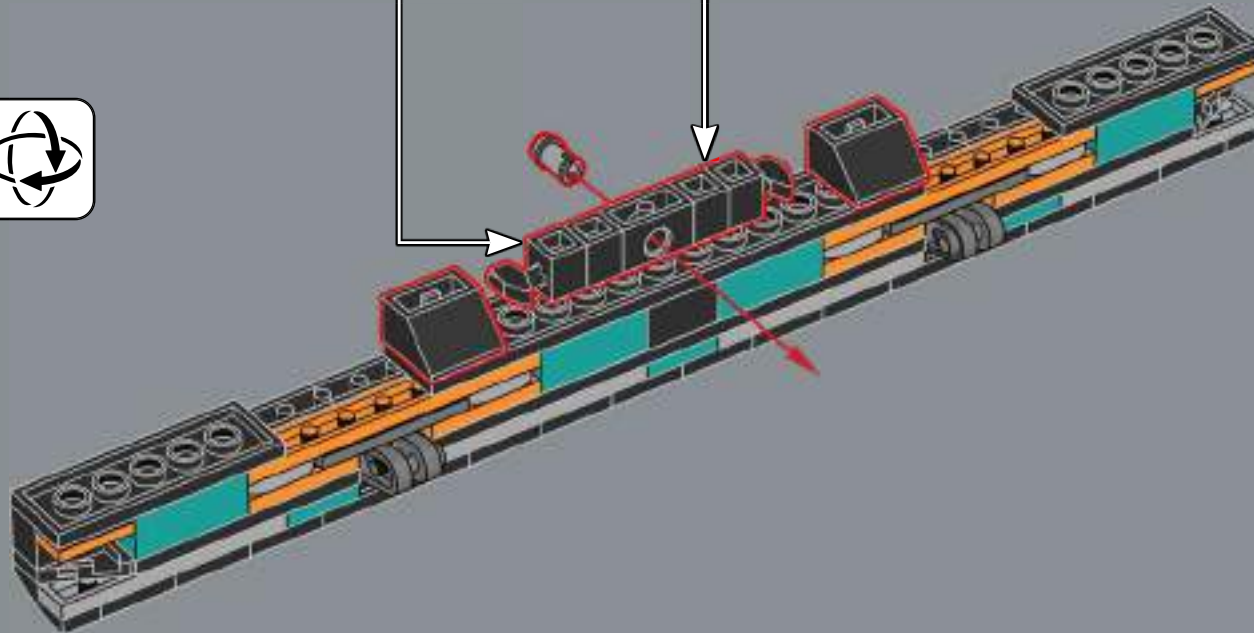

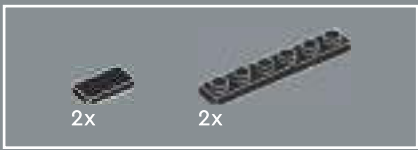

76

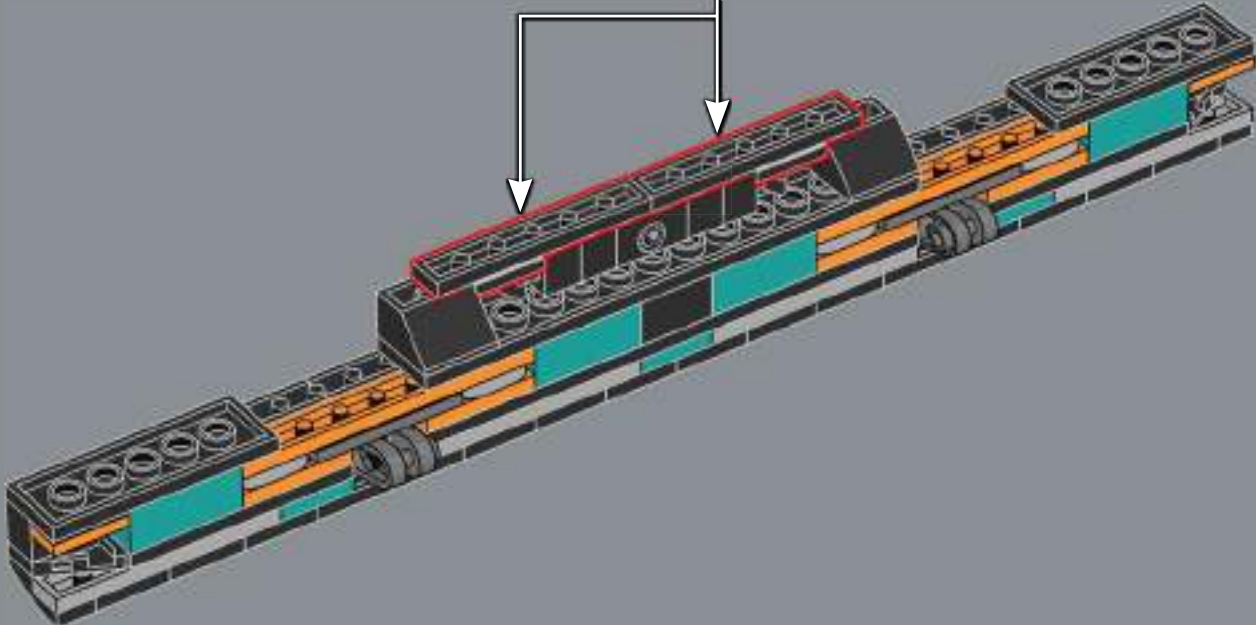
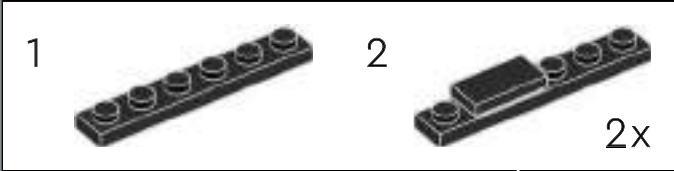



77

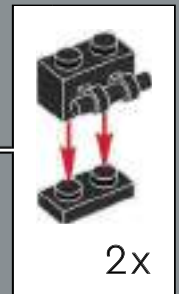
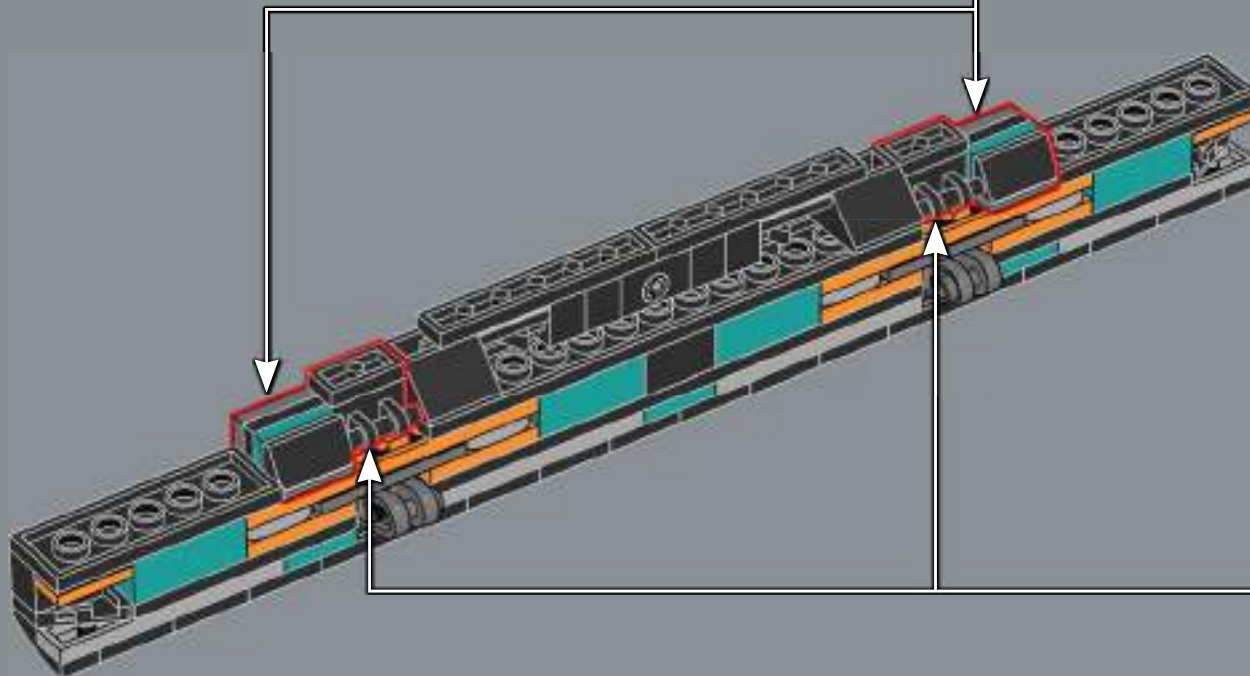
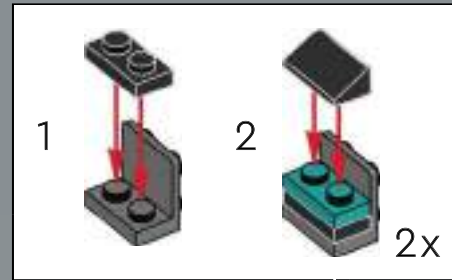

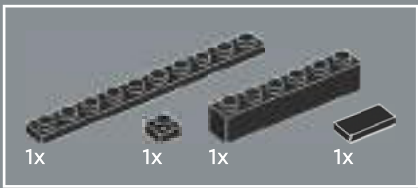

78

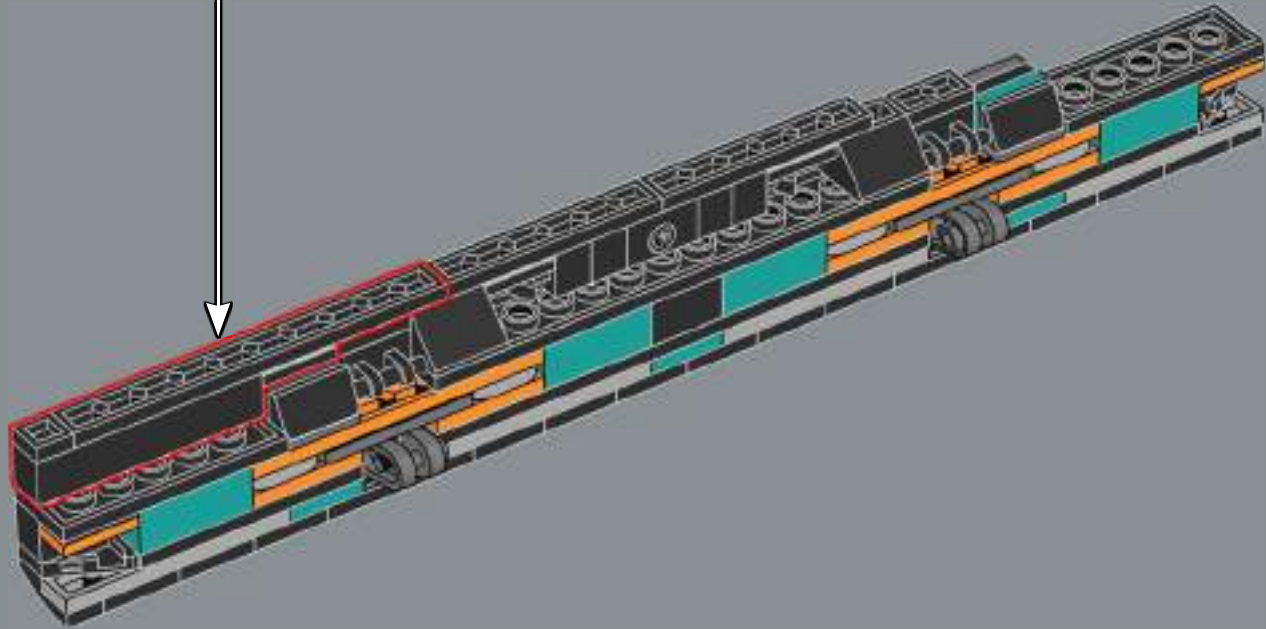
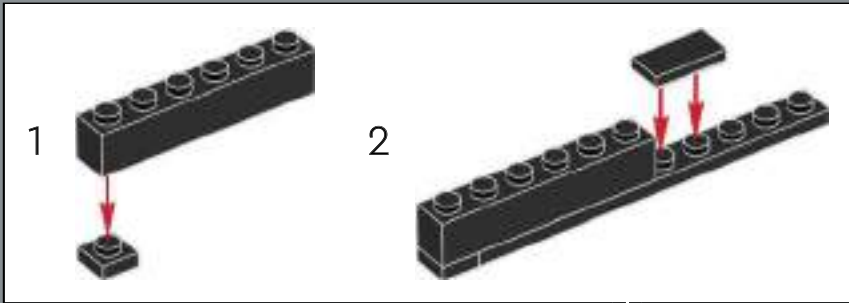

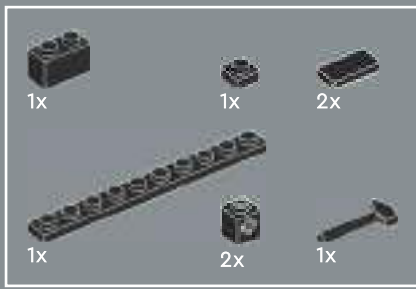

79

1



2

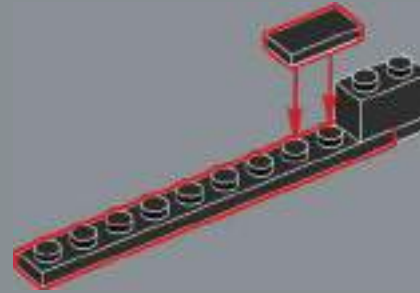

3

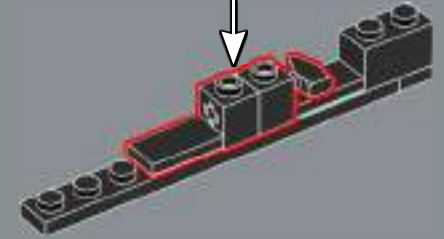

Introduced in 1980, the CX-2600A model of the VCS reduced the front switch count to four and relocated the two difficulty switches to the back of the console.

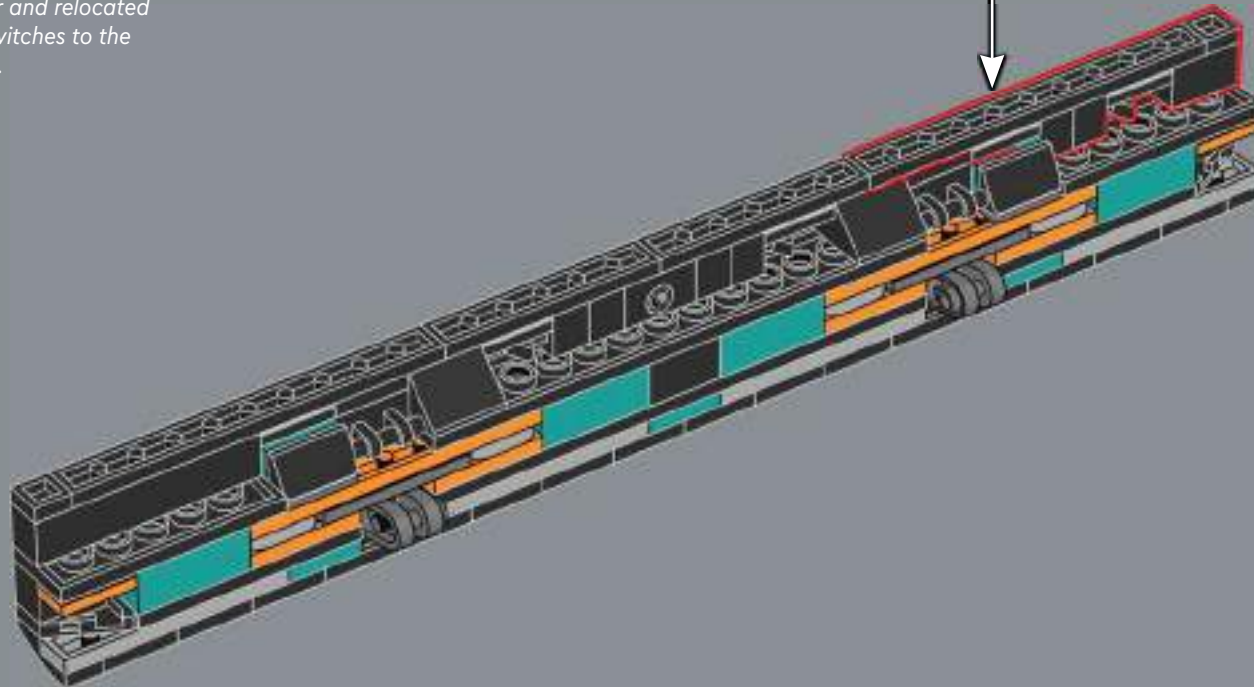

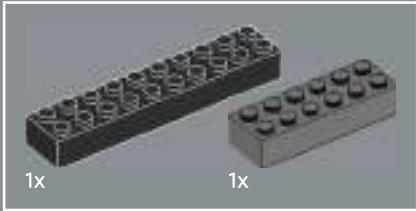
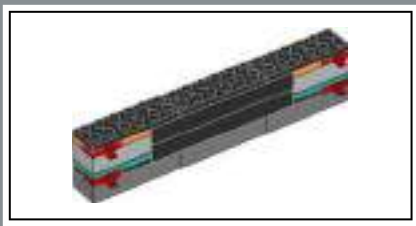

80

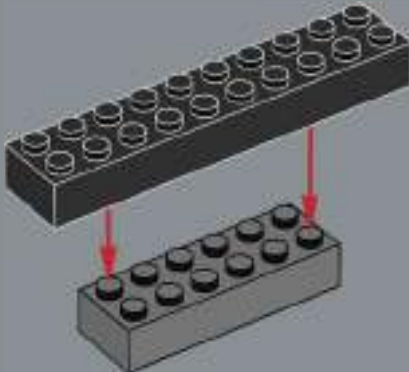

81

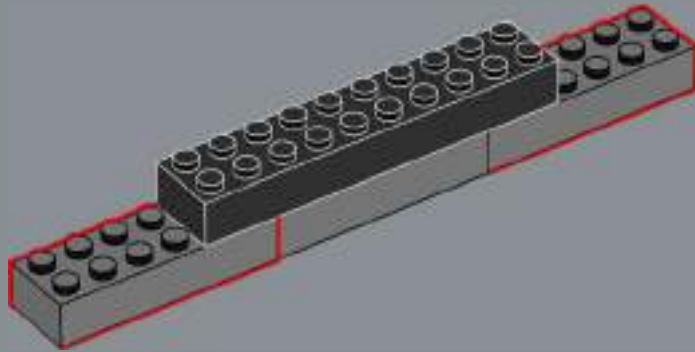

82

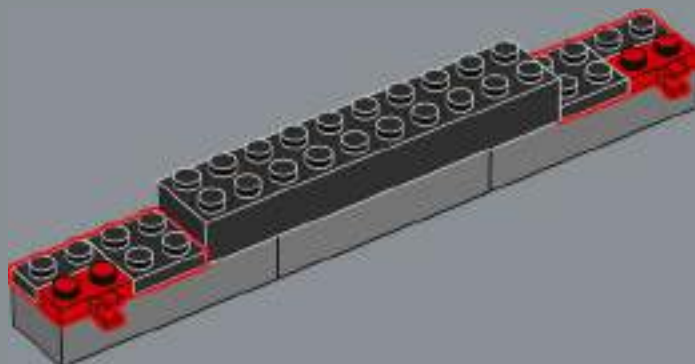



83

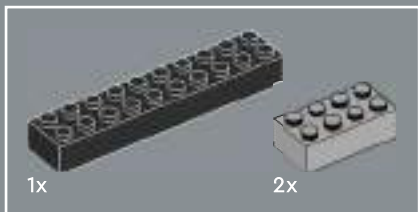
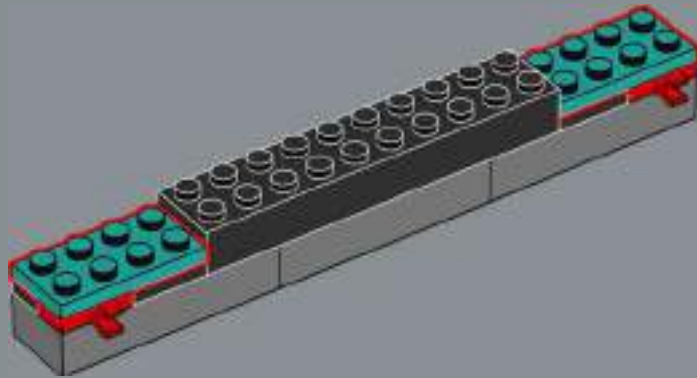

84

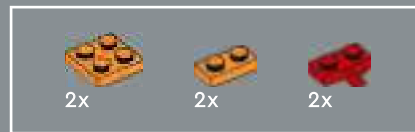
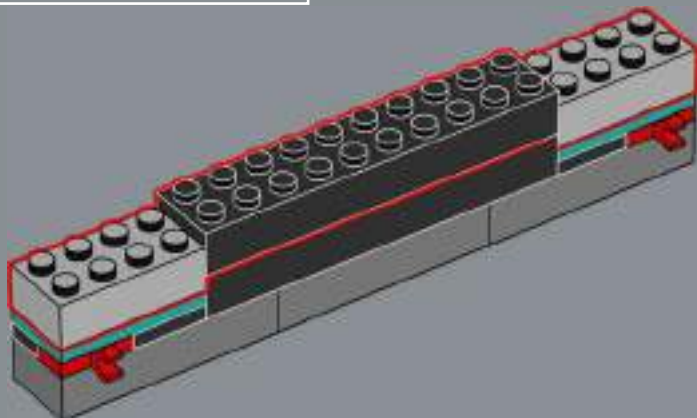

85

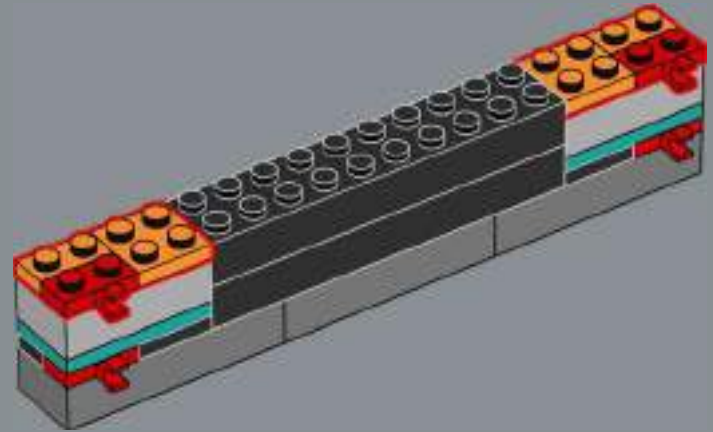

86

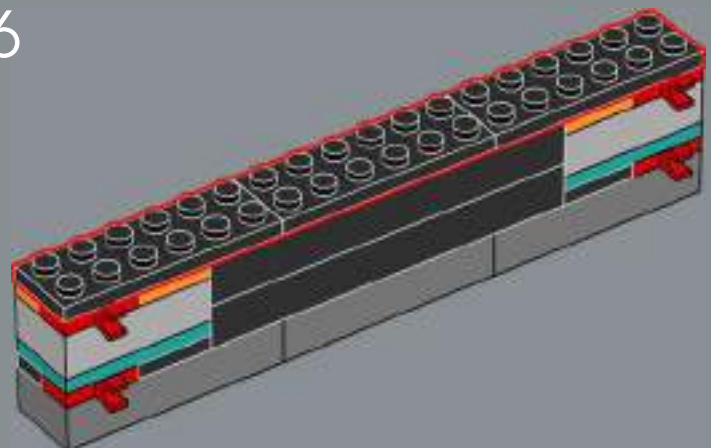

87

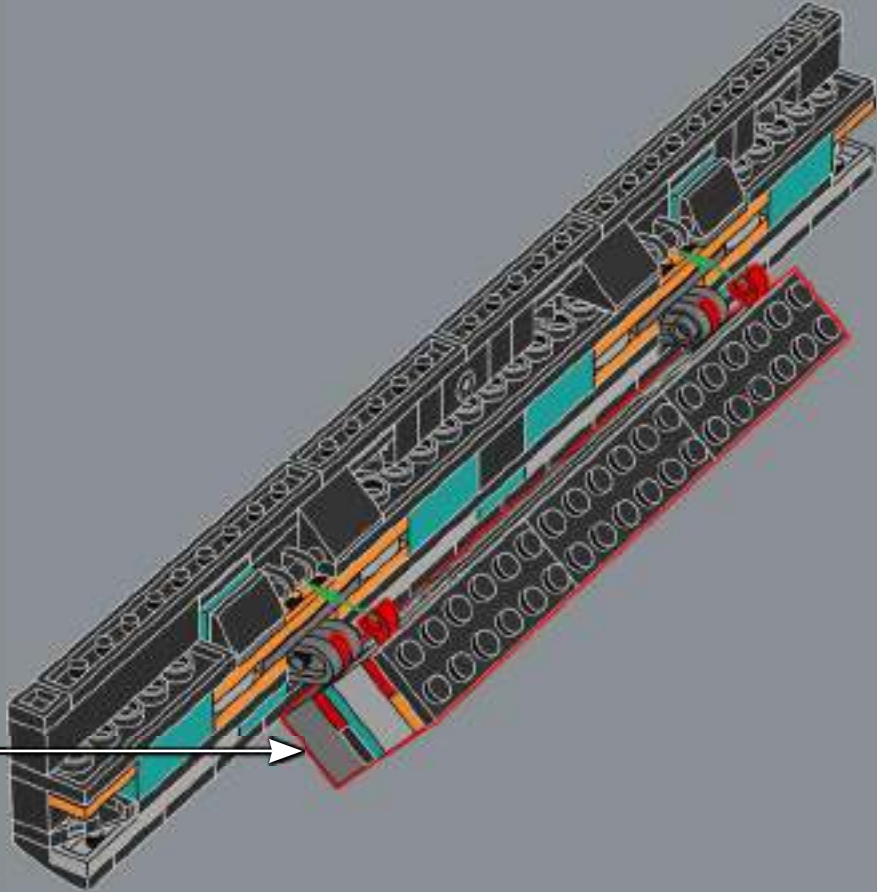

88

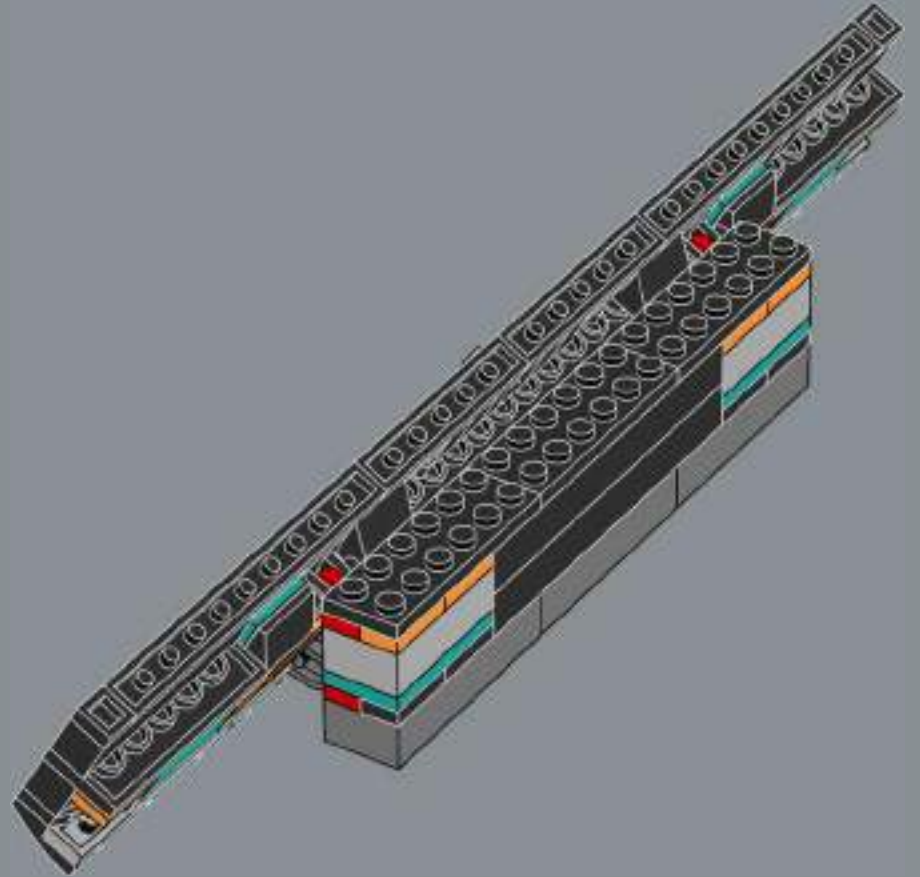

89

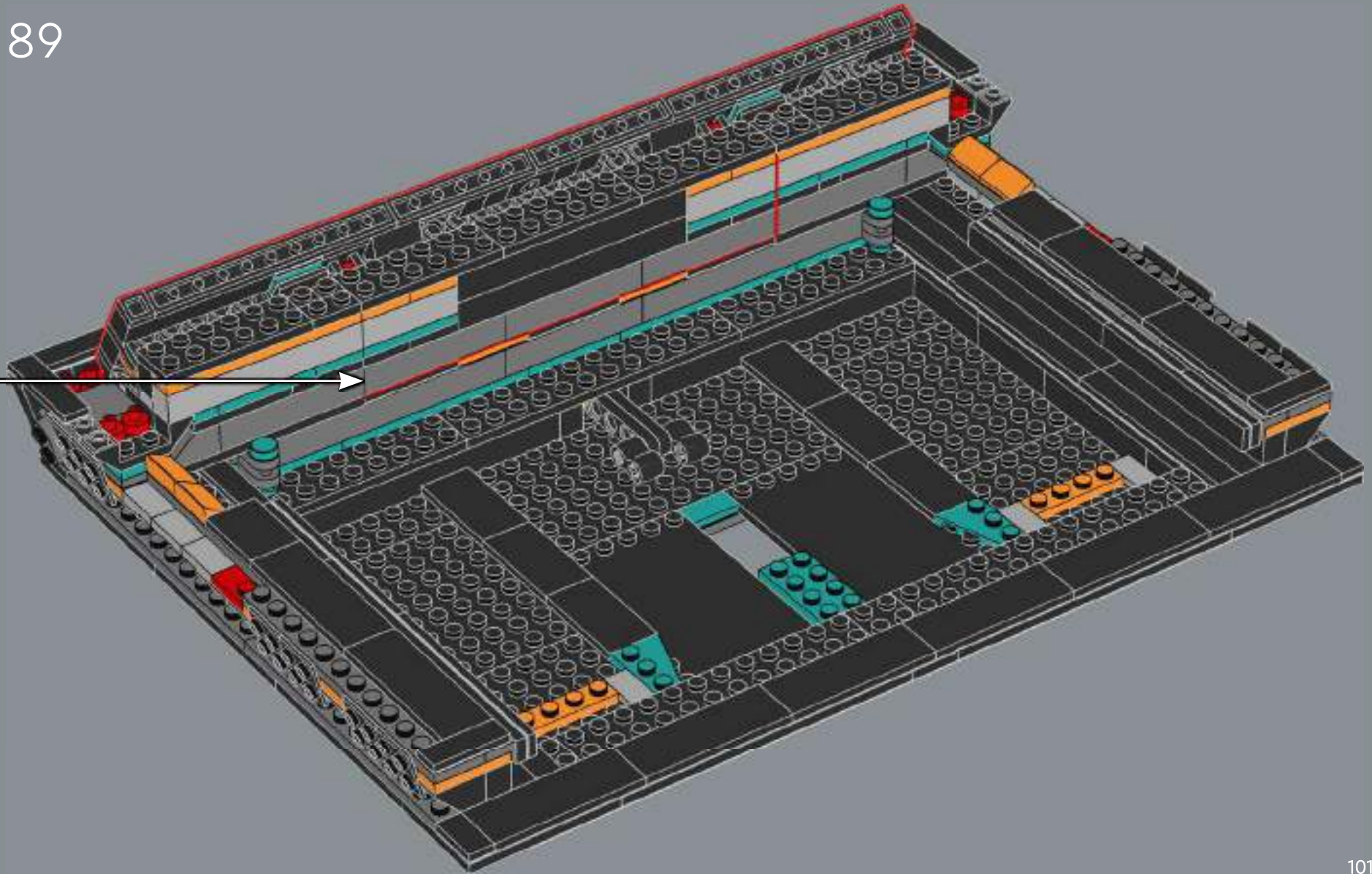



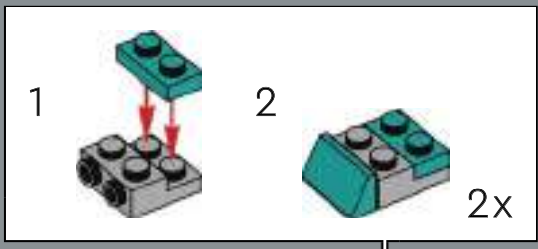
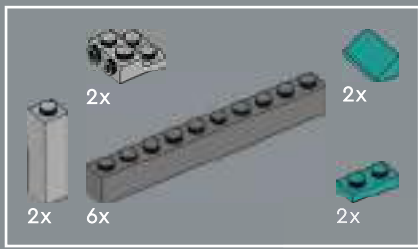

90

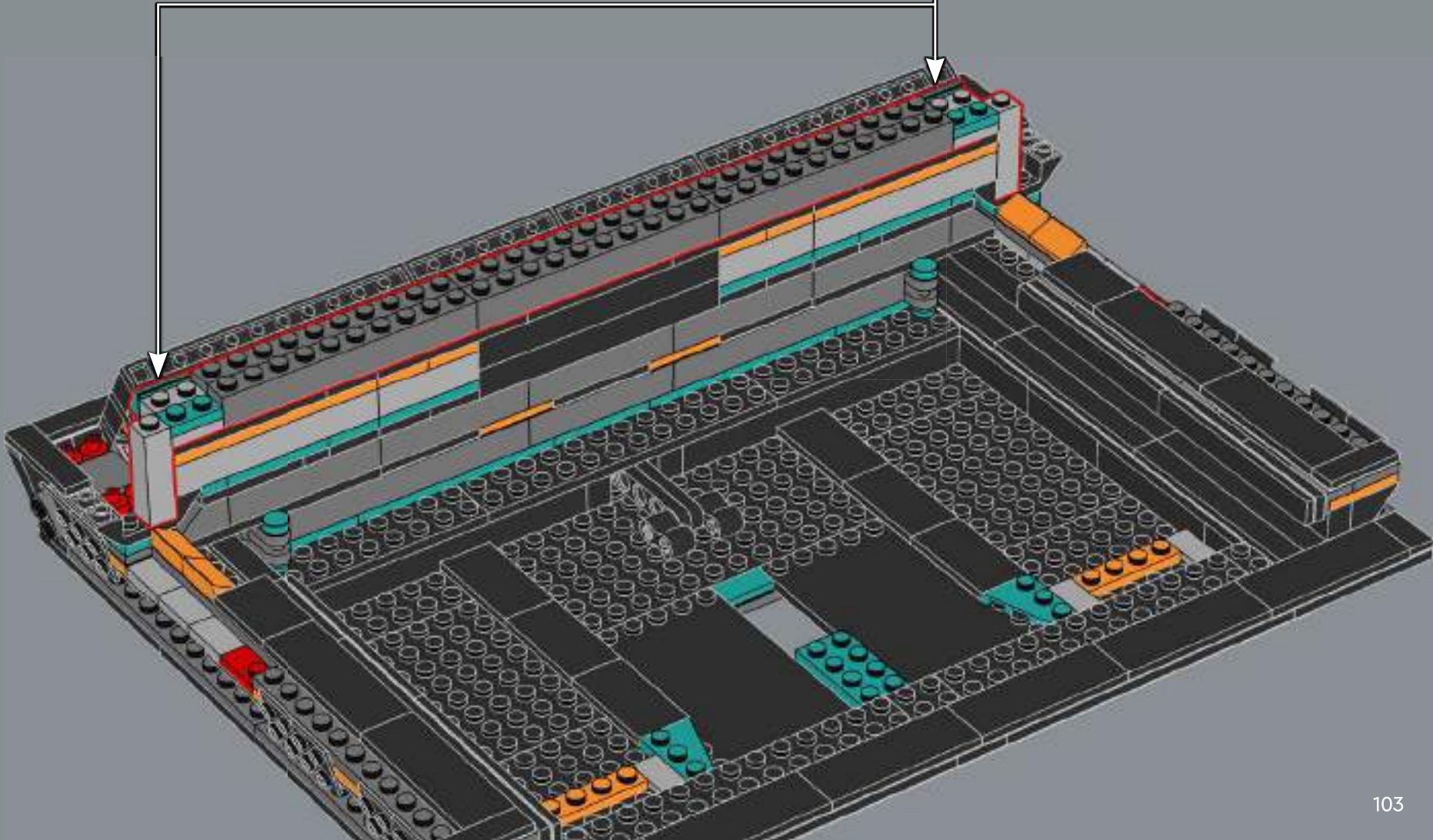



91

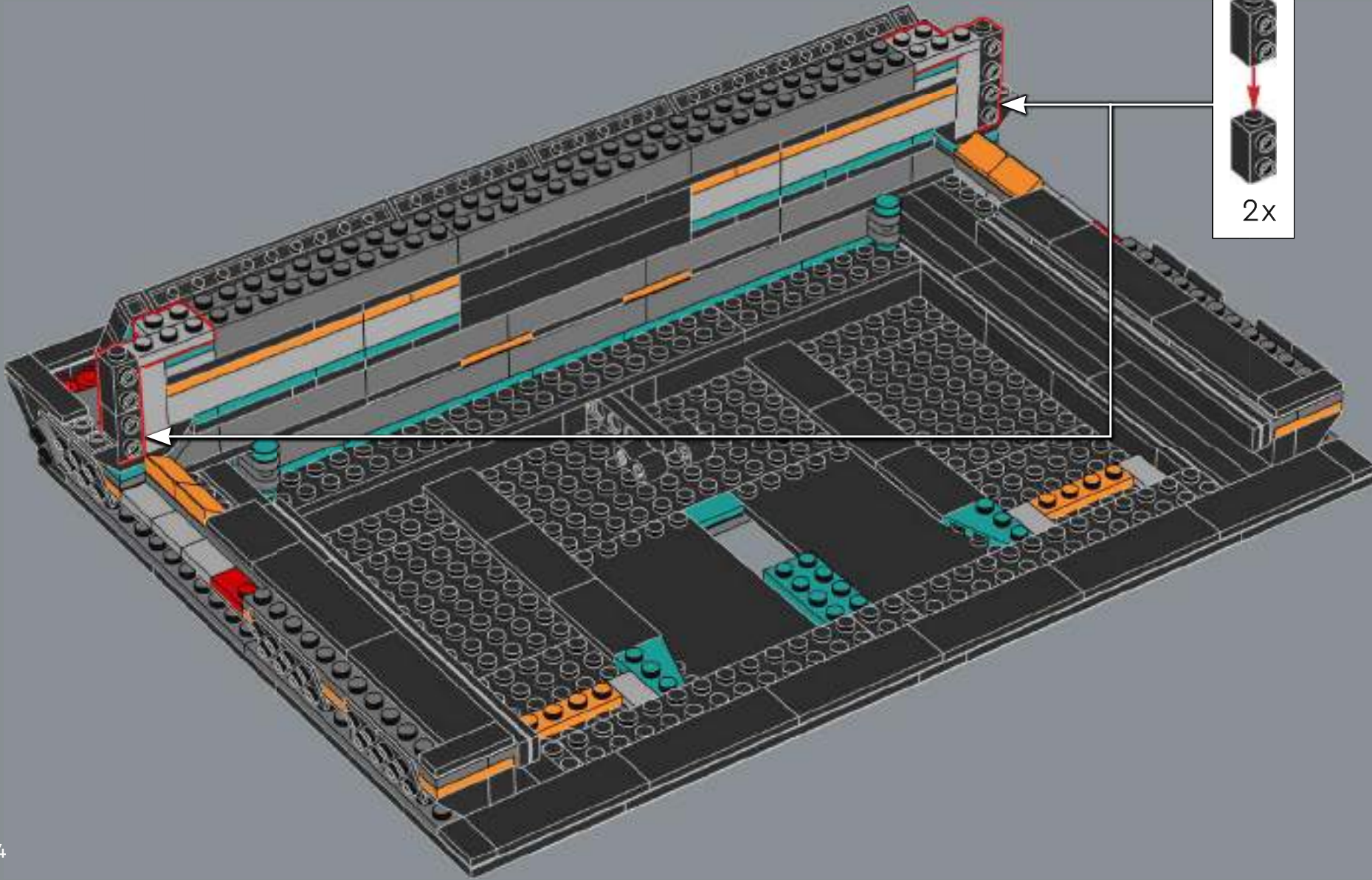

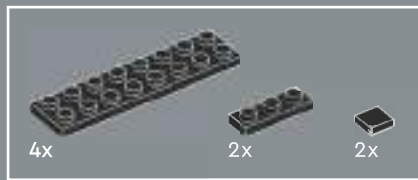

92

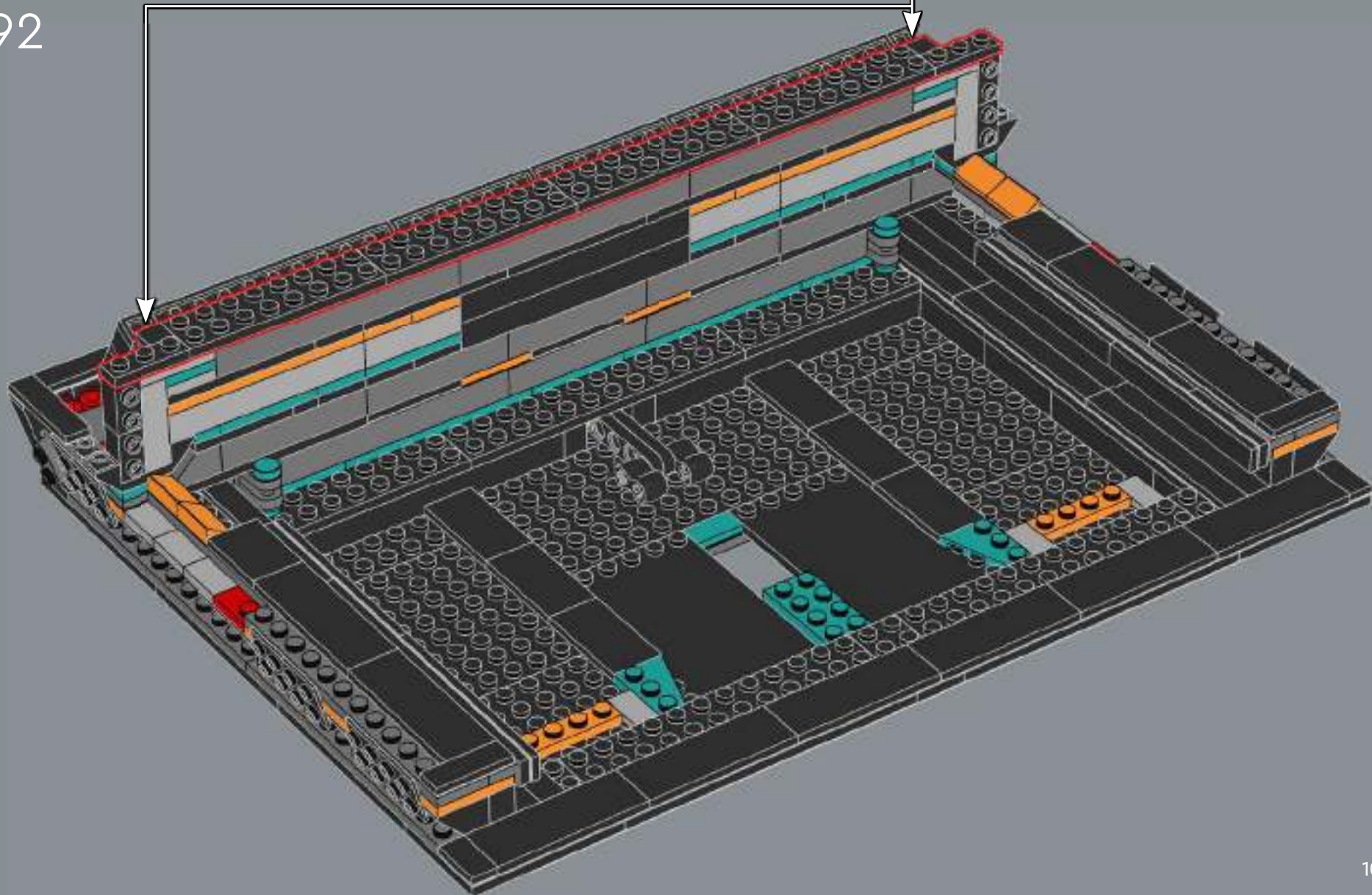



93

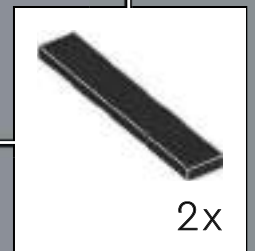
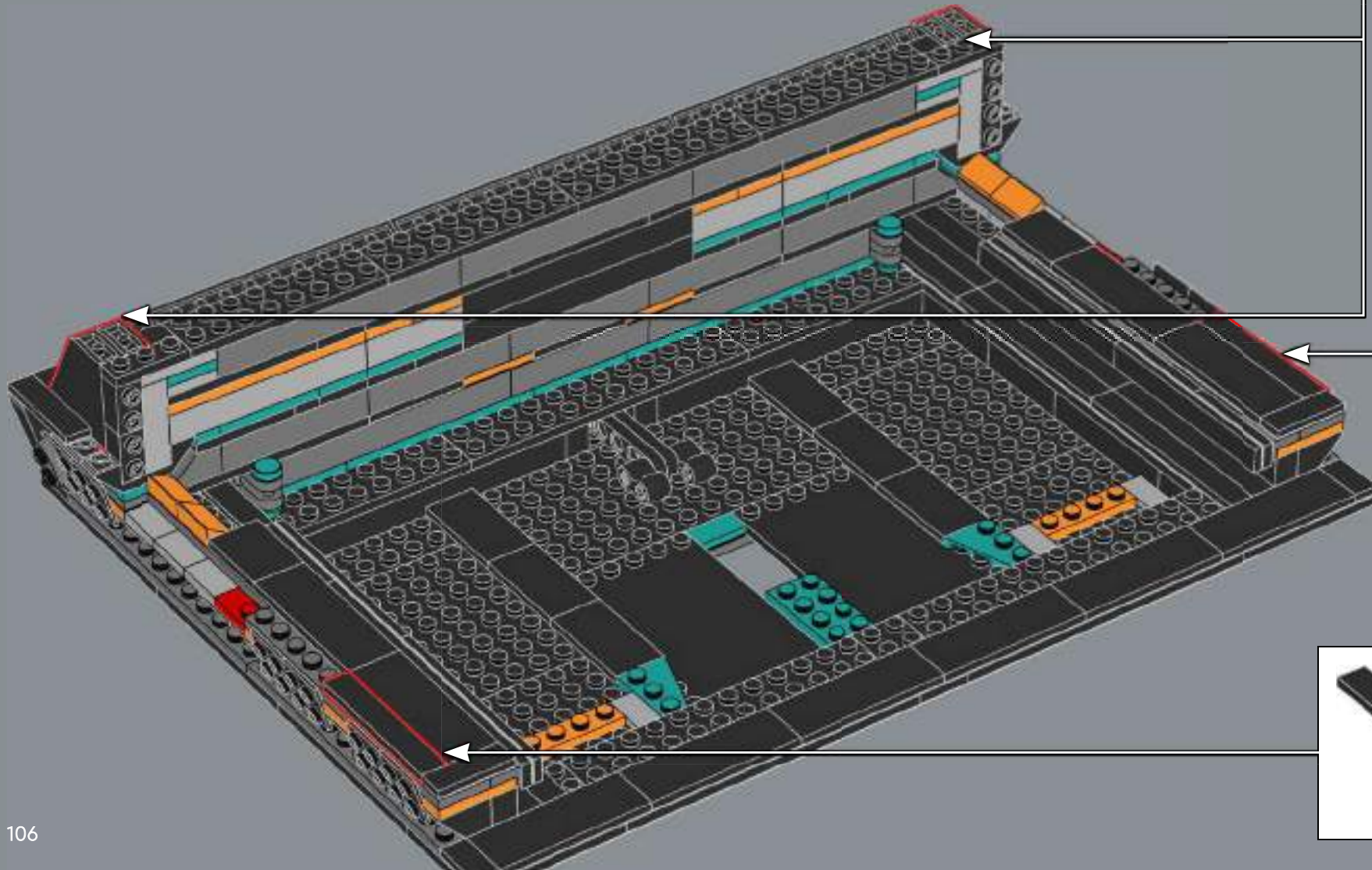
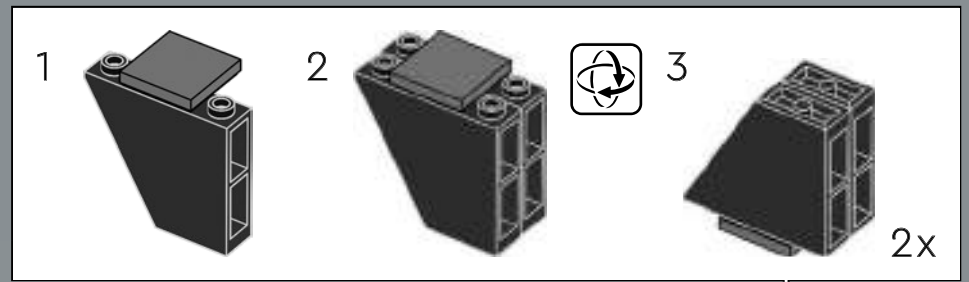

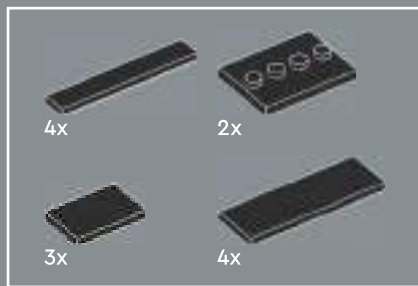

94

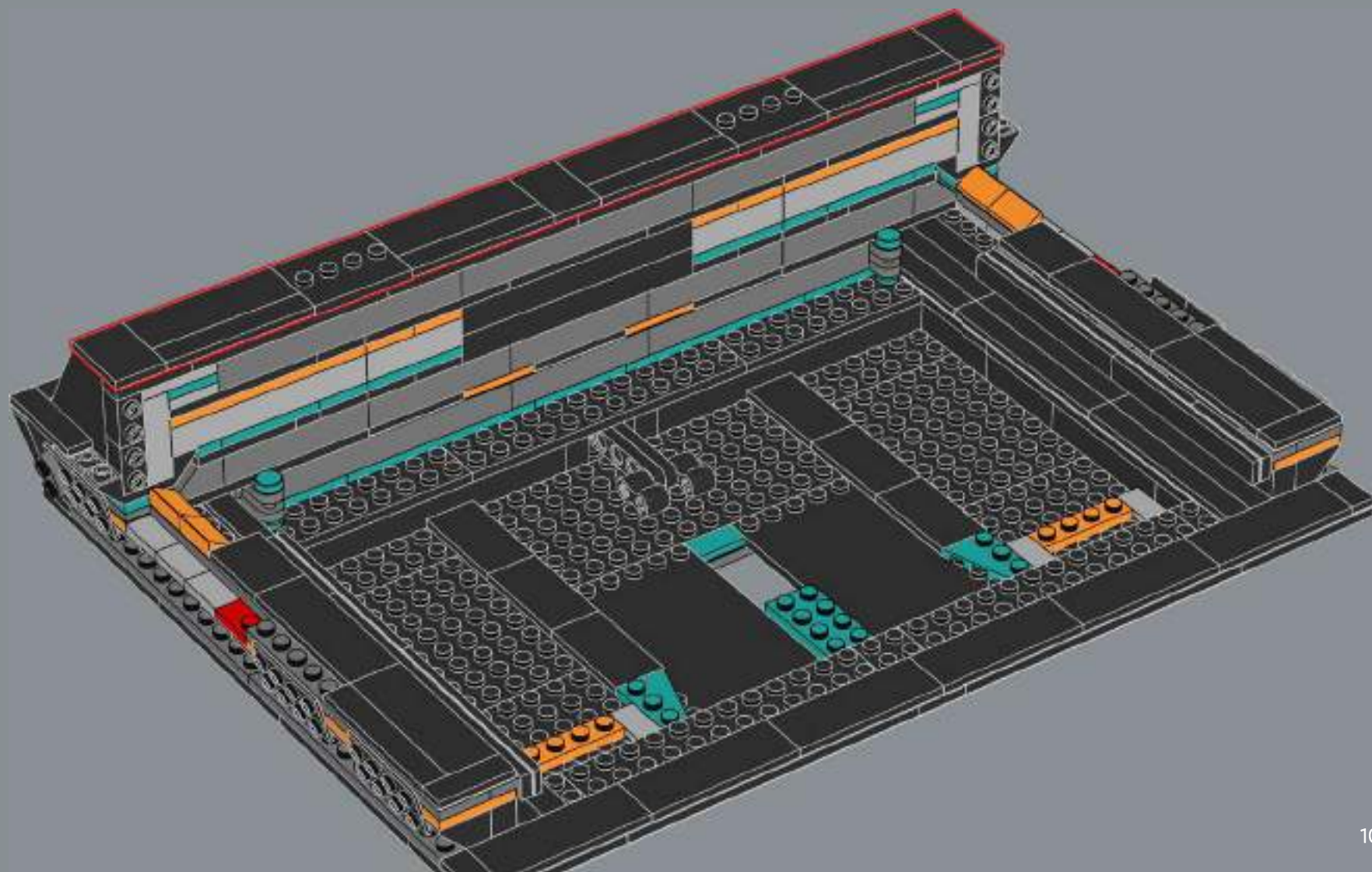

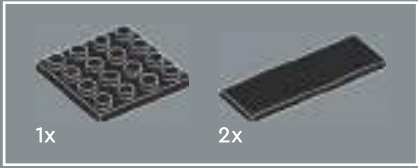

95

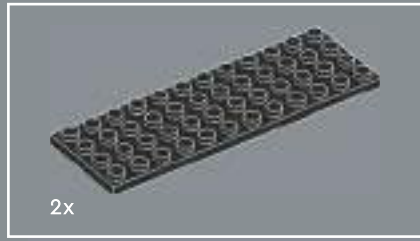
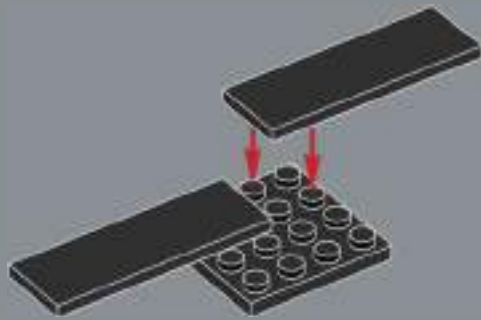

96

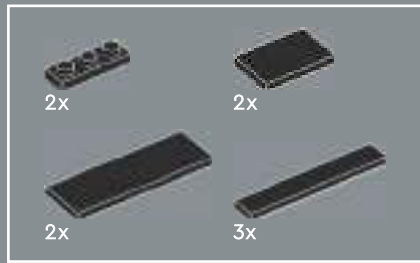
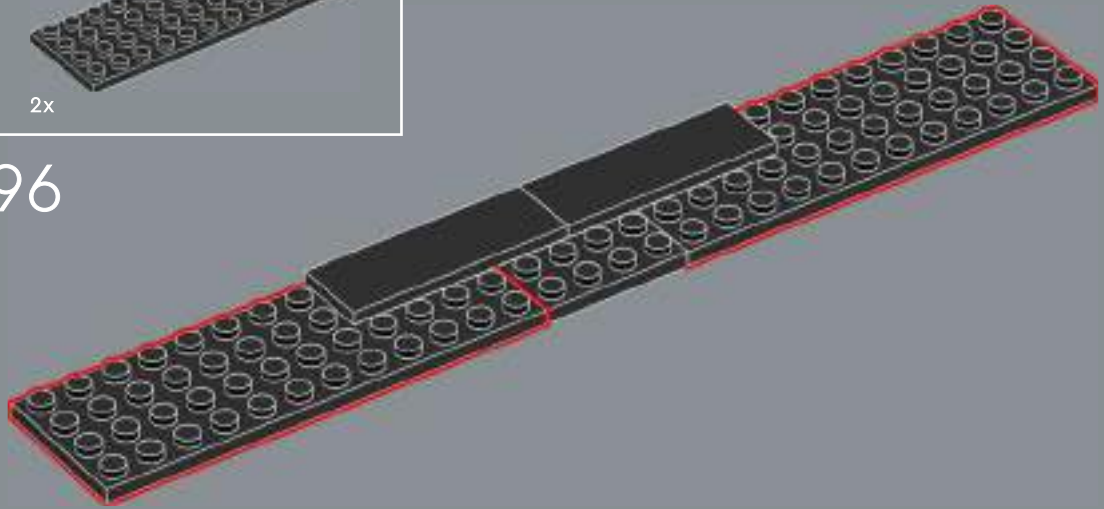

97

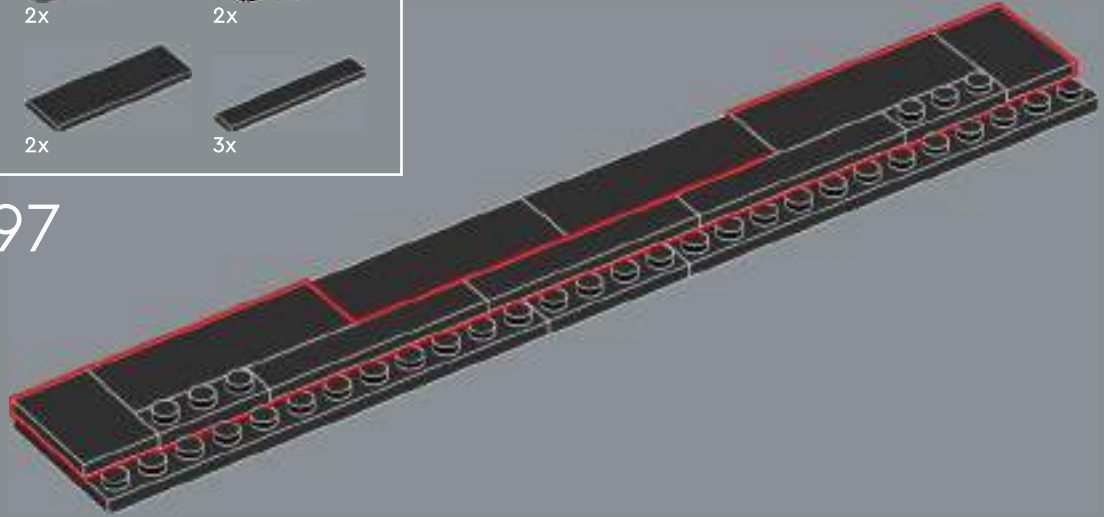



98

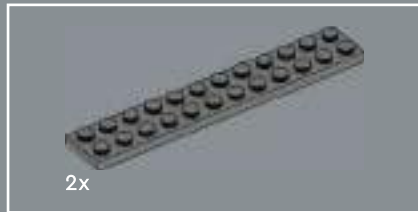
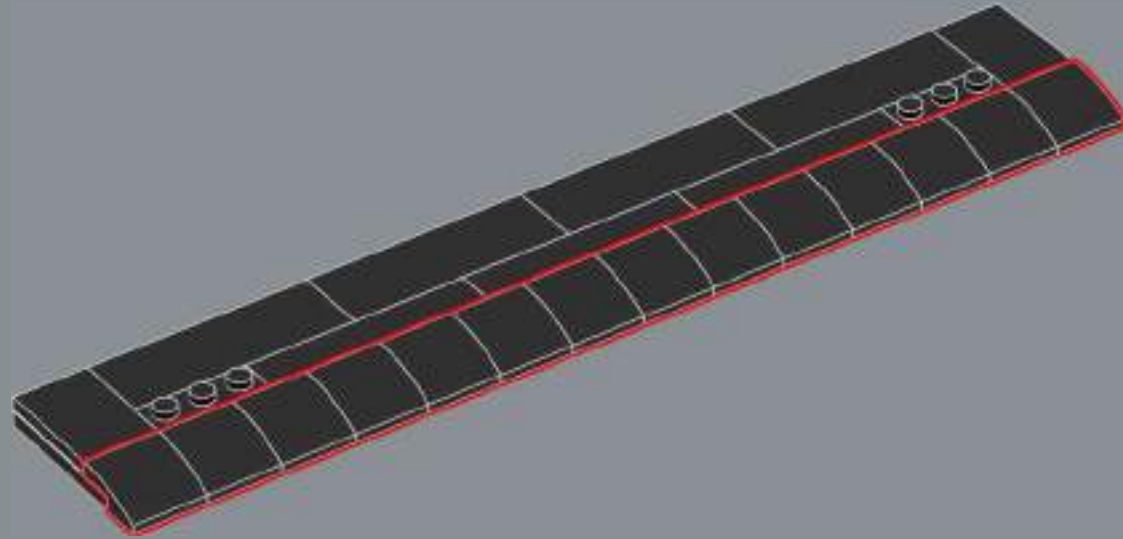

99

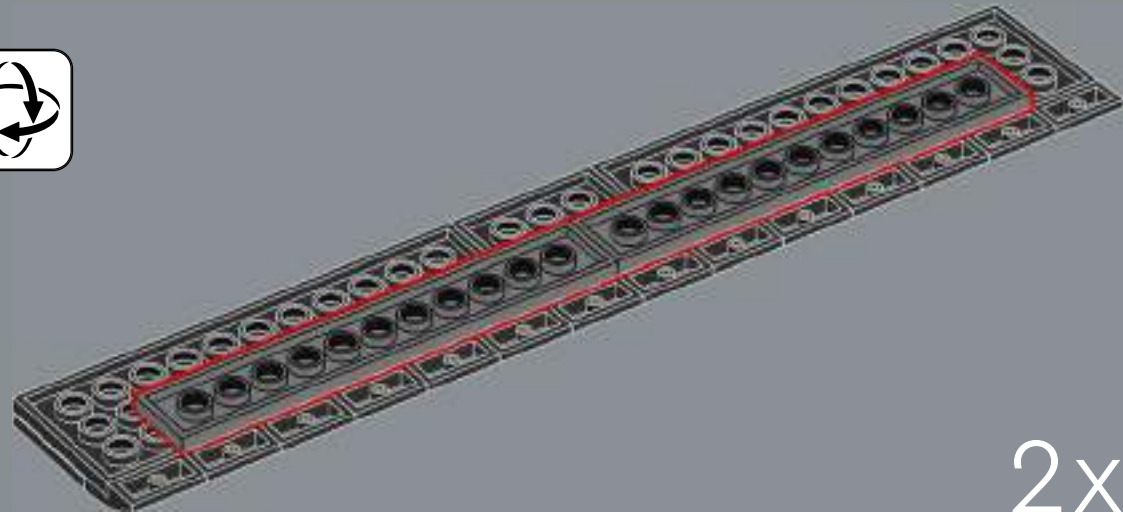

2x

100

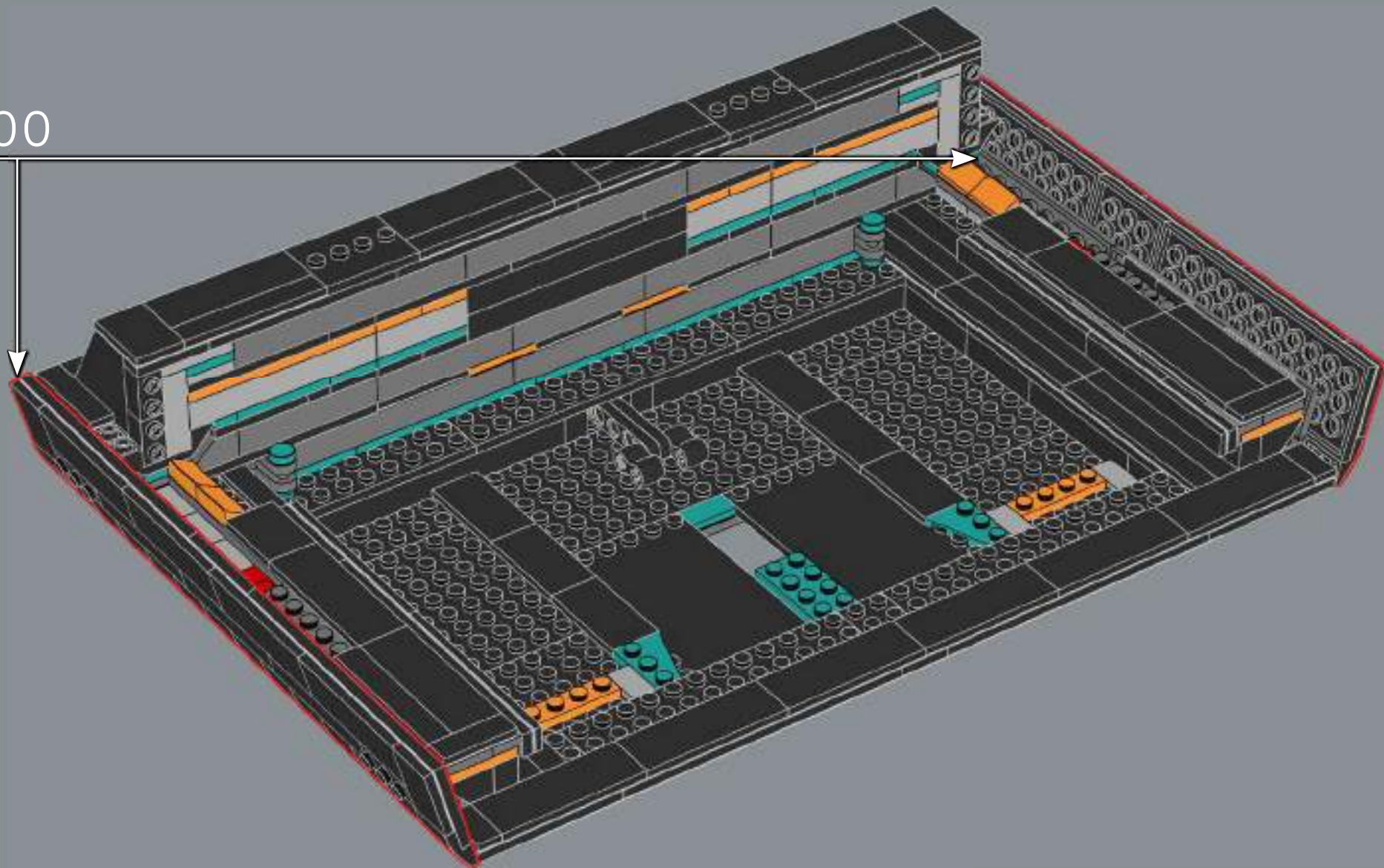

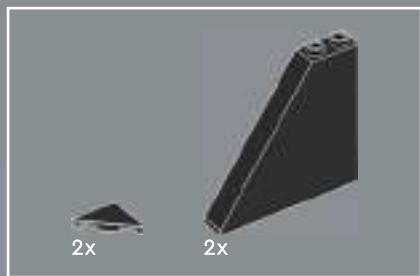

101

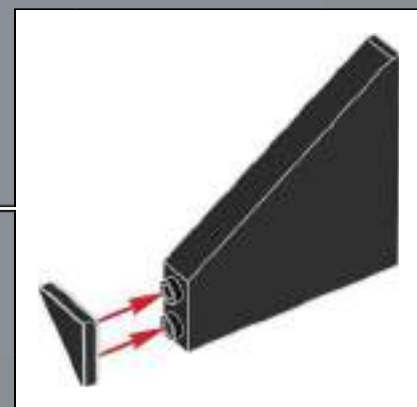
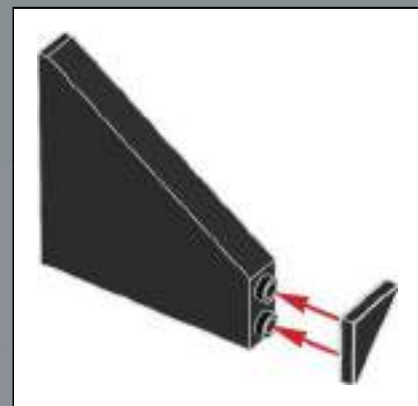
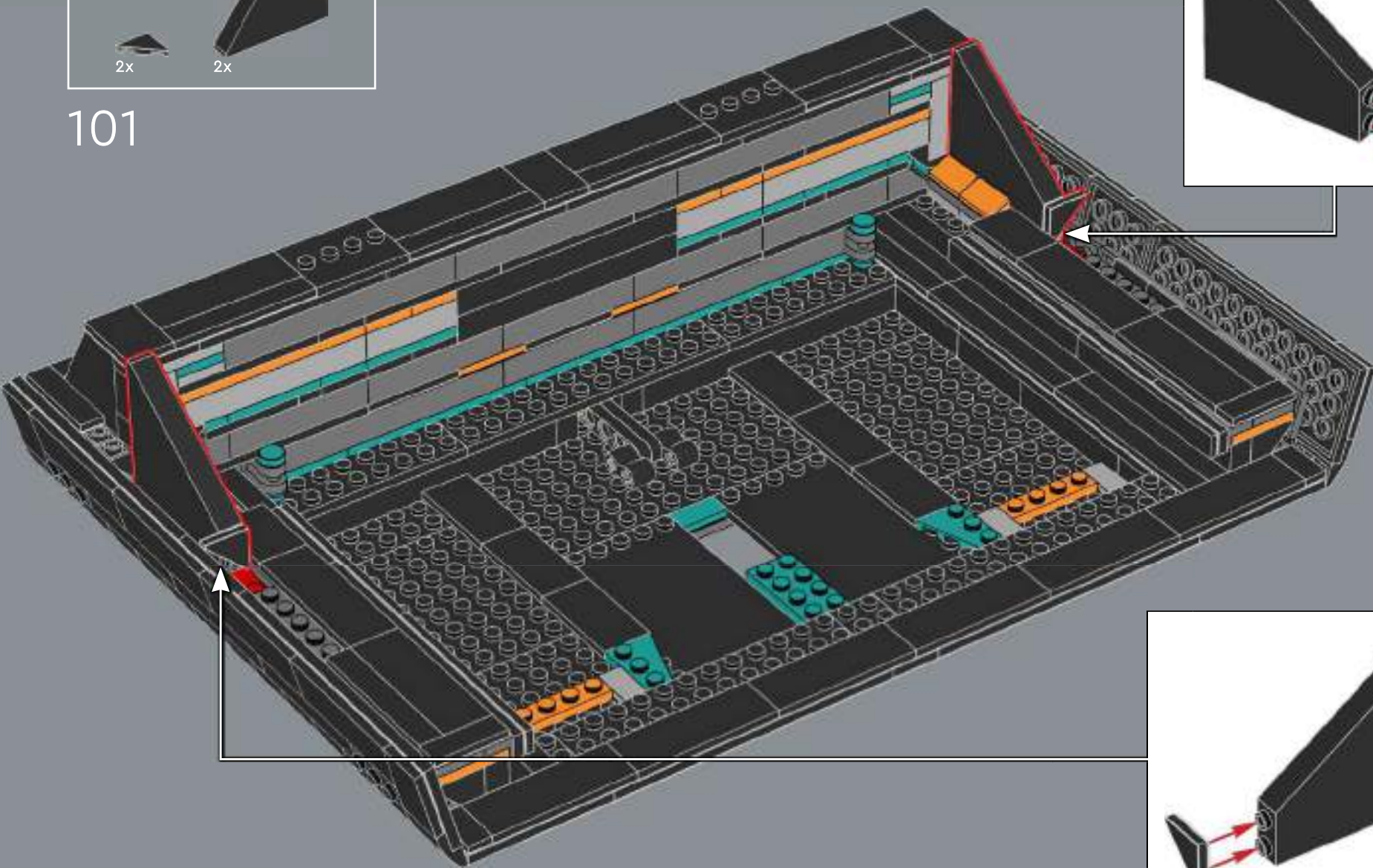



102

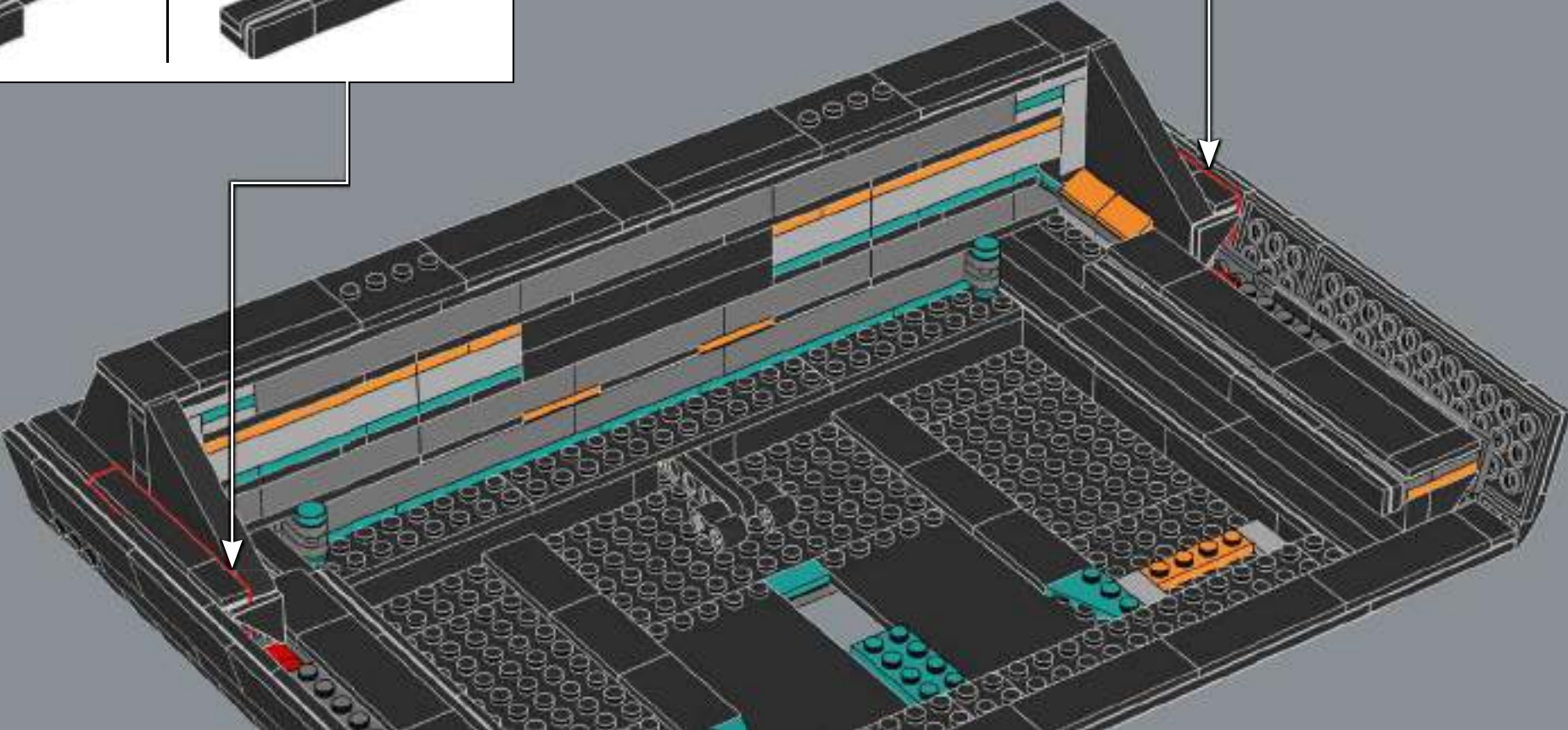
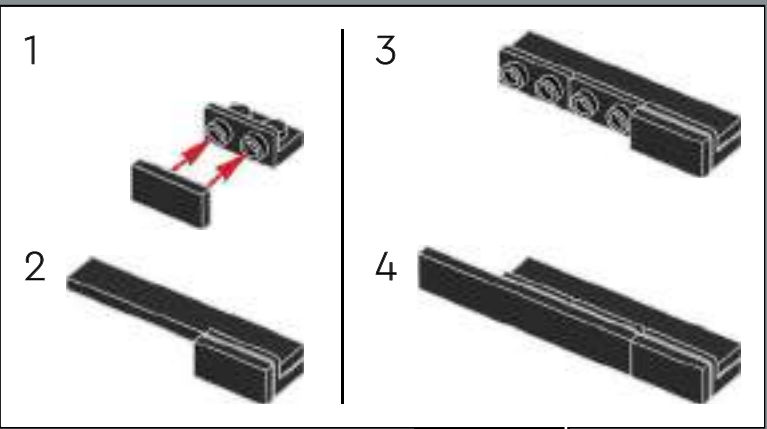
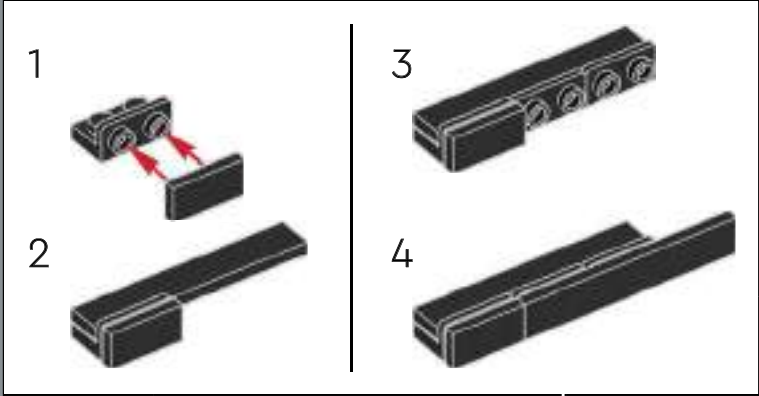



103

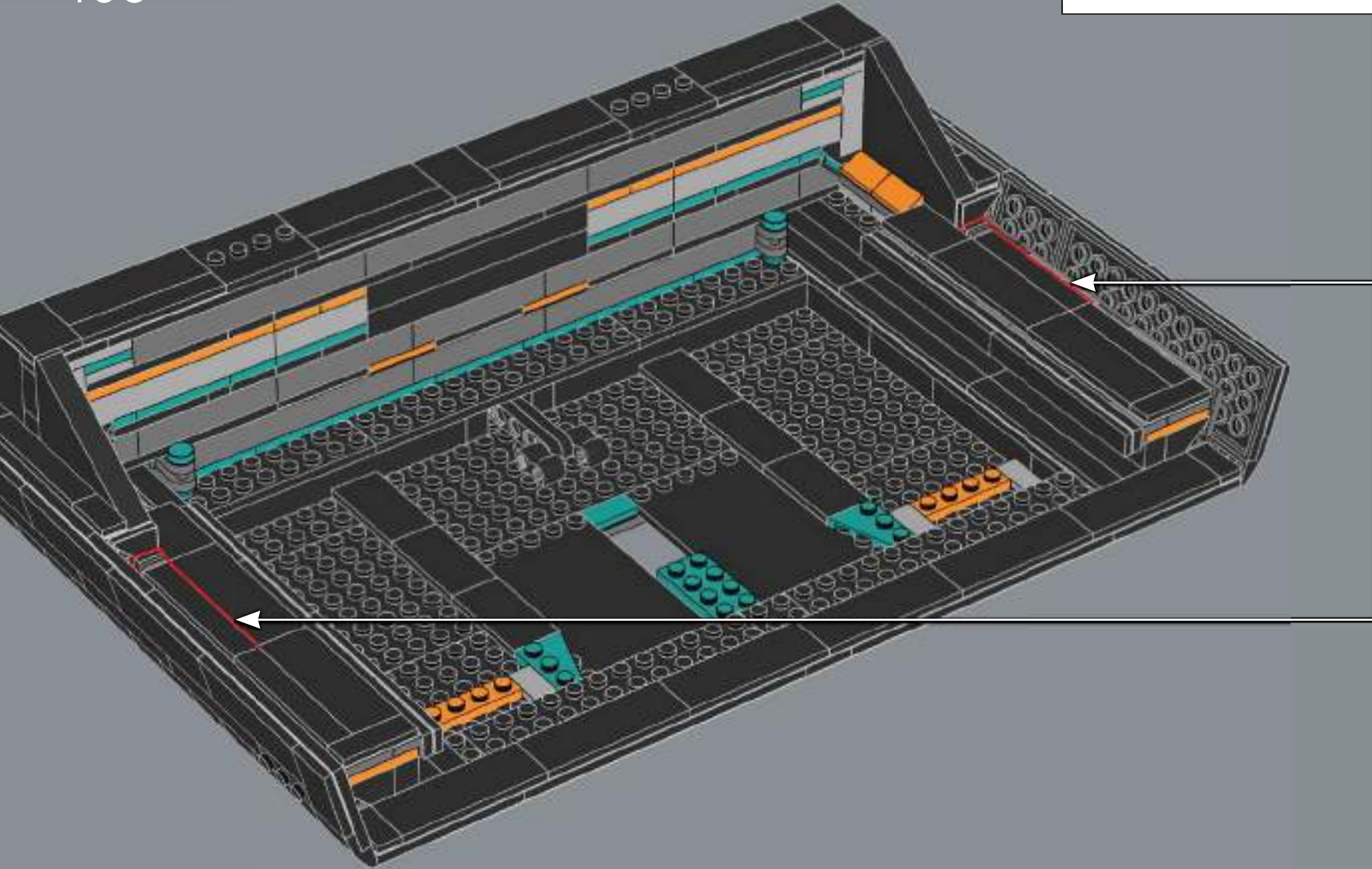
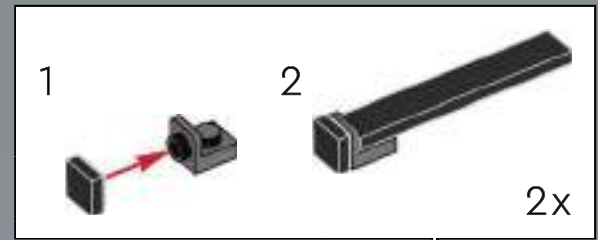

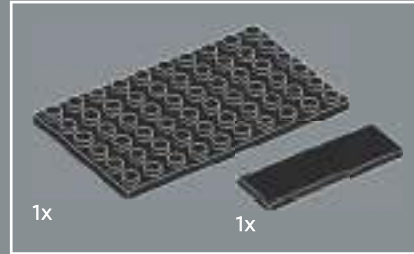

1

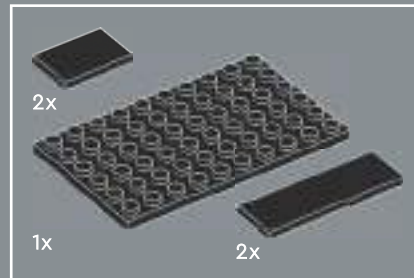
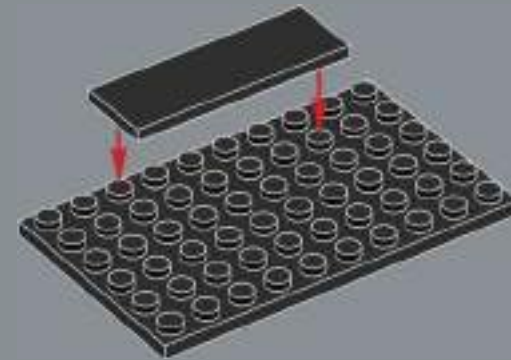

2

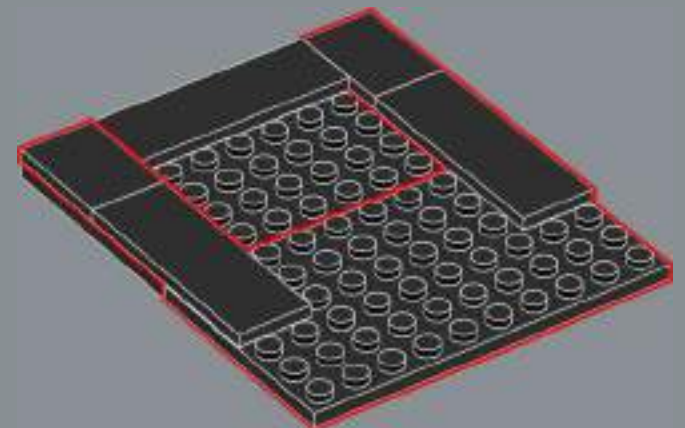

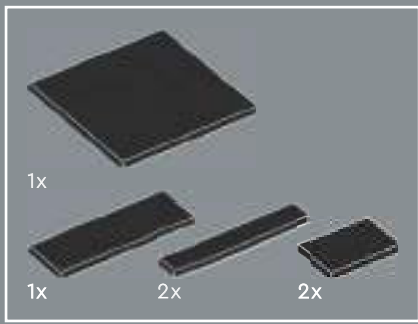

3

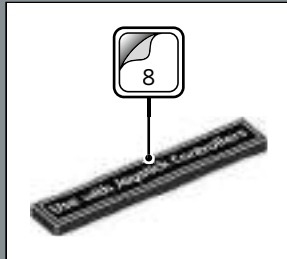

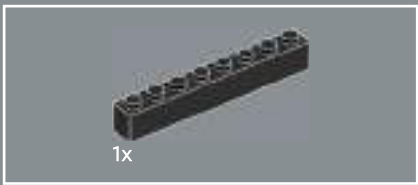

4

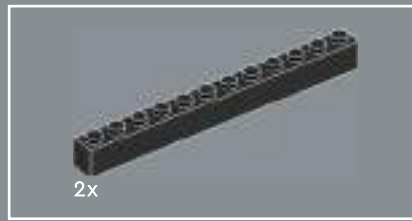
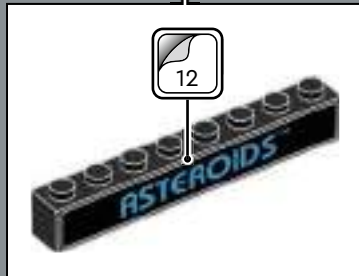

5

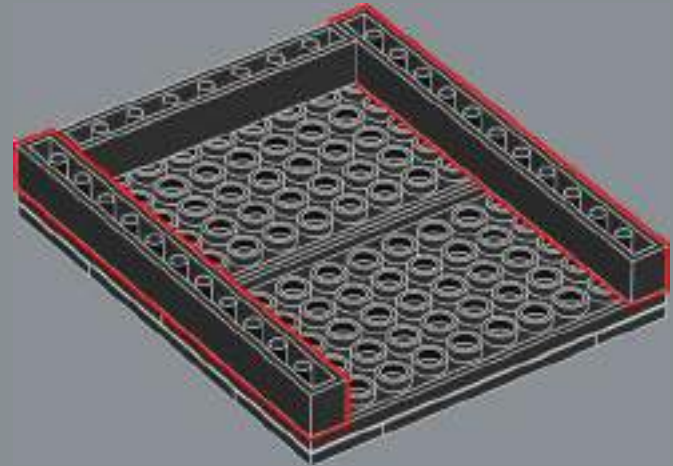



6

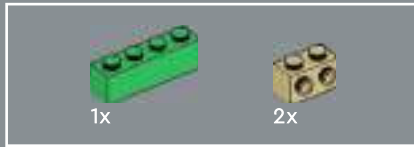
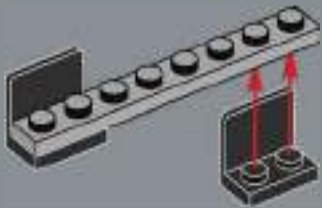

7

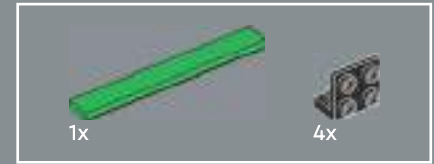
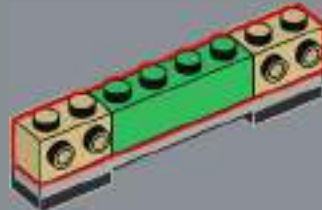

8

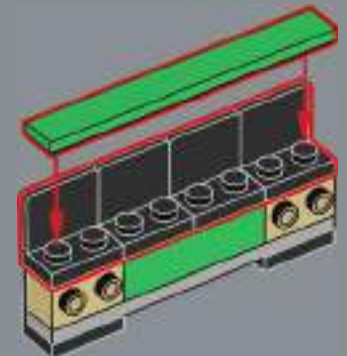

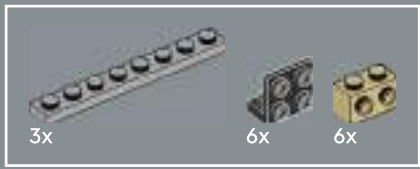

9

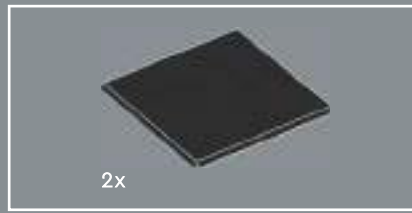
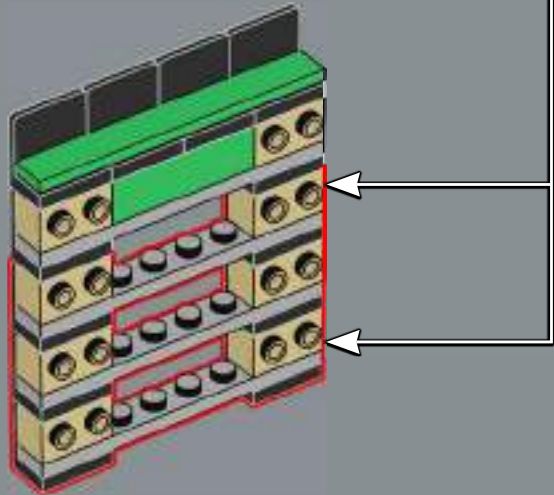
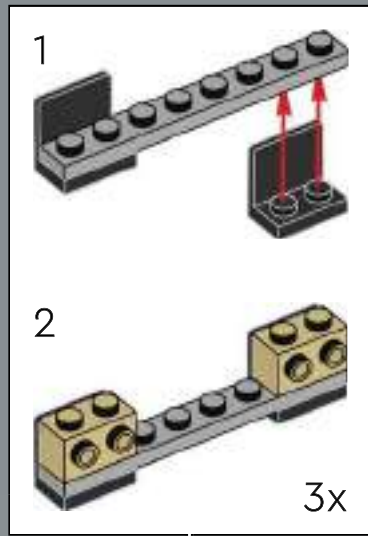

10

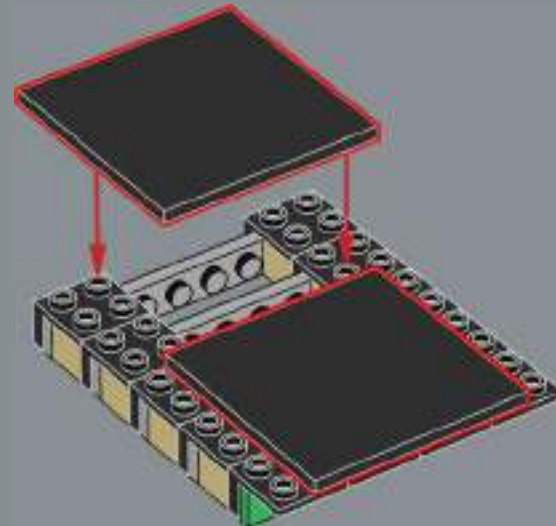

11

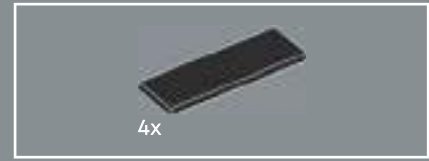
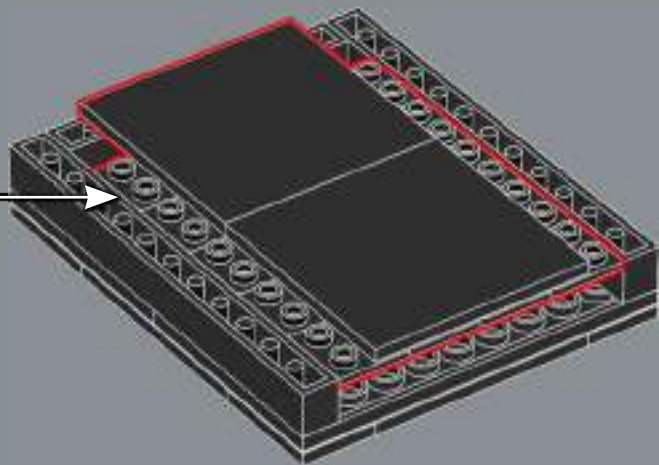

12

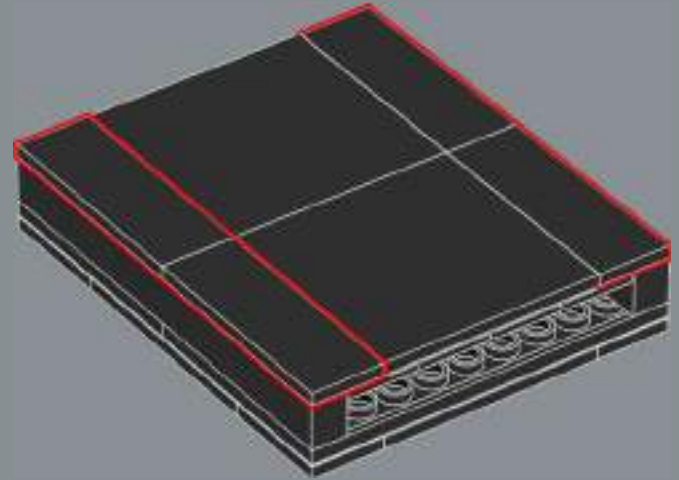

13



All cartridge artwork has been abstracted to include LEGO® elements, but the Asteroids artwork is particularly special because it features the new LEGO 10497 Galaxy Explorer. 

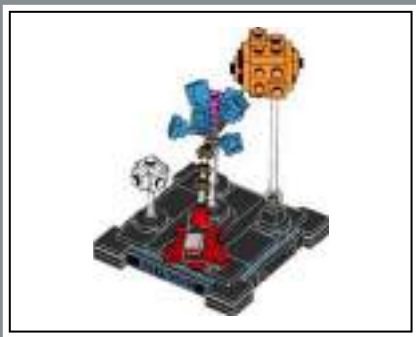

1

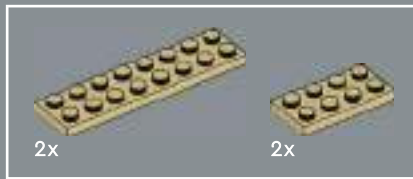

2

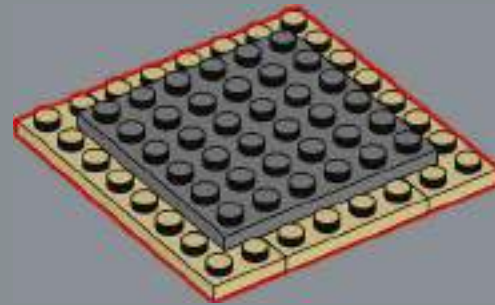

3

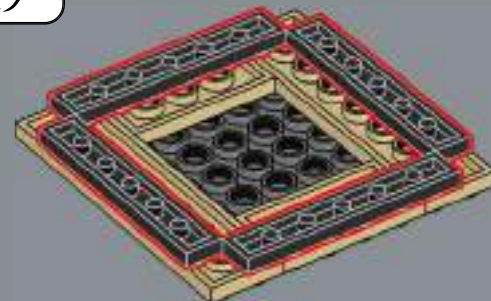



4

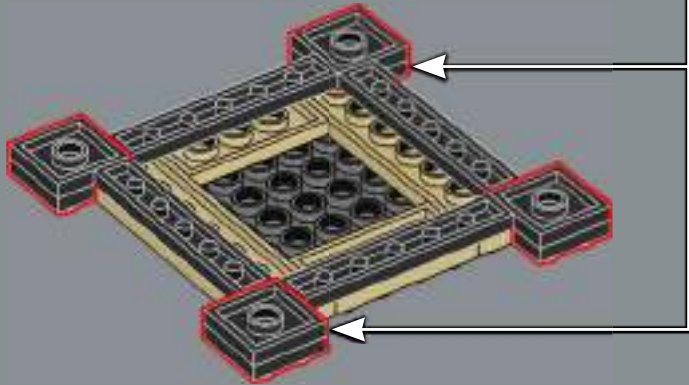
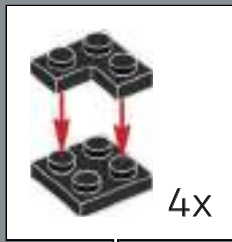

5

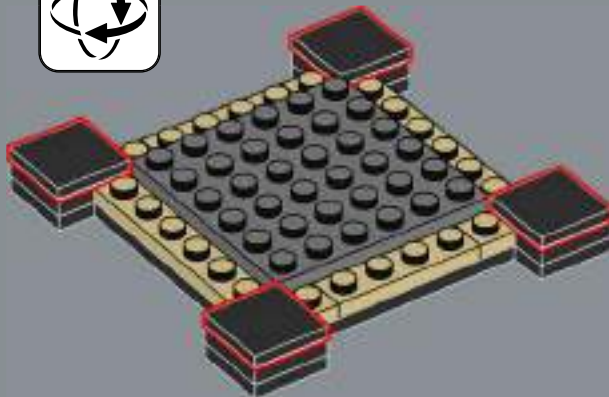

6

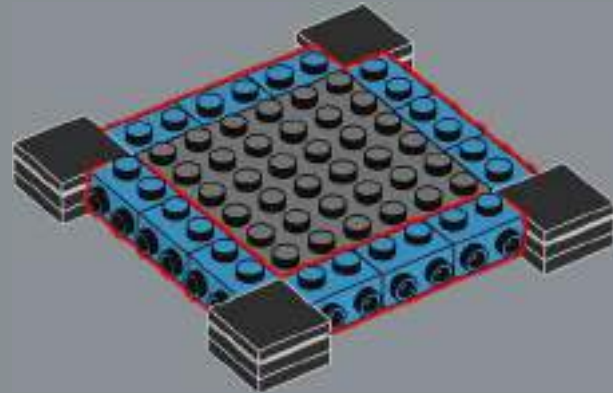

7

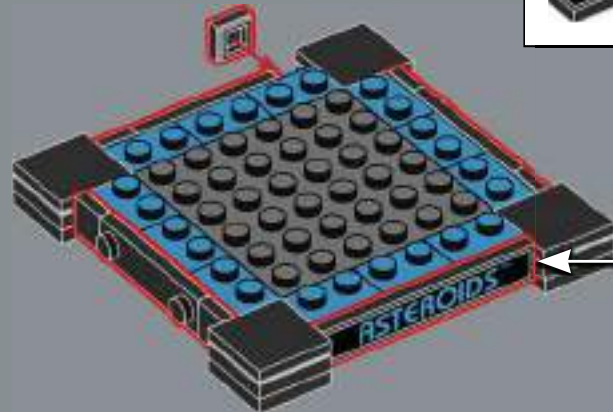
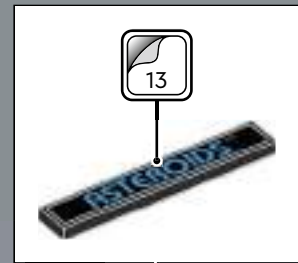

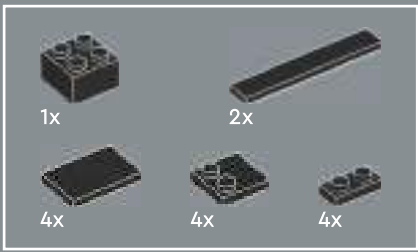

8

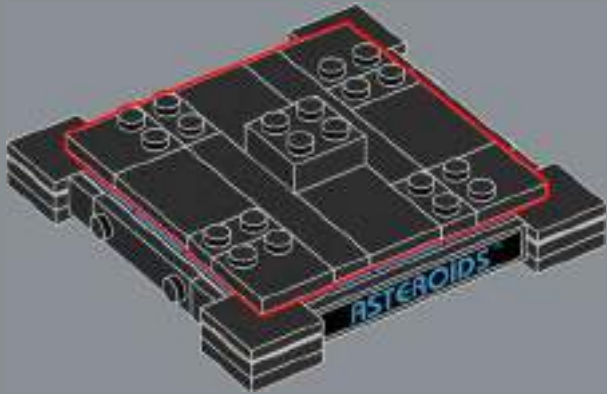

9

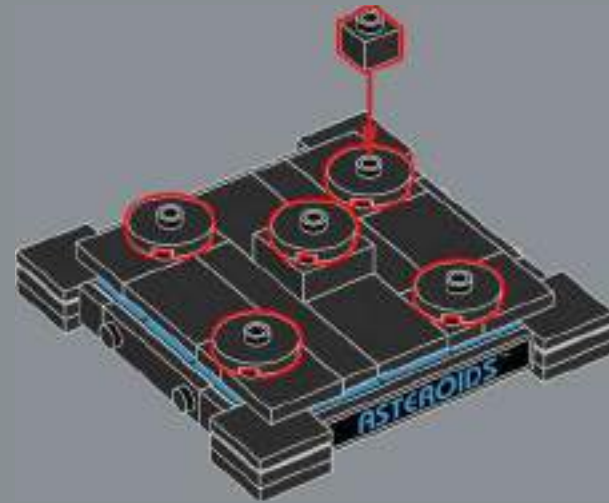

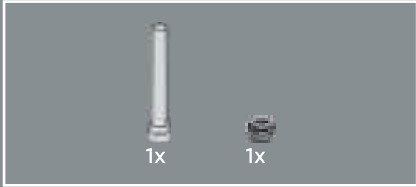

10



11

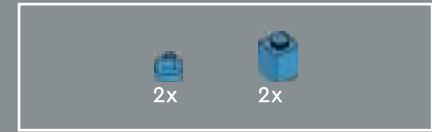

12

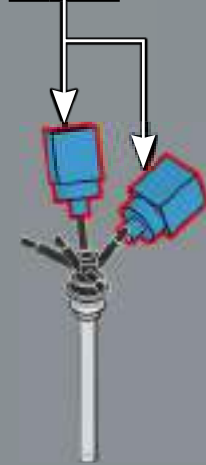

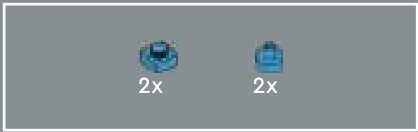

13

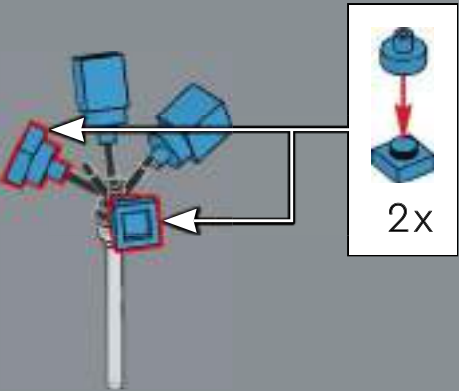

14

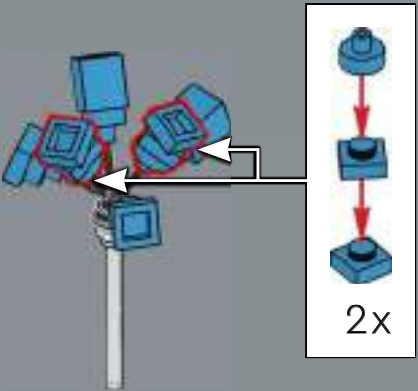

15

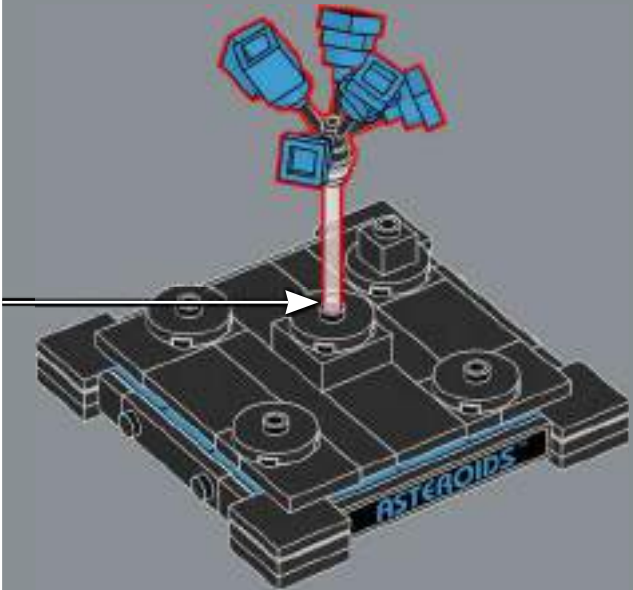

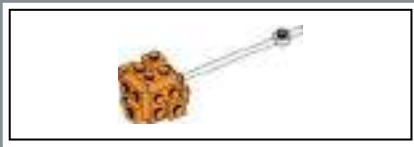

16

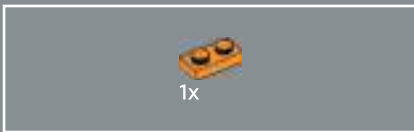

17

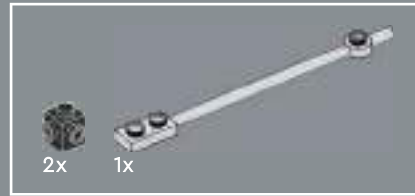

18

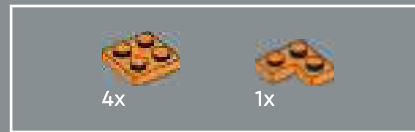
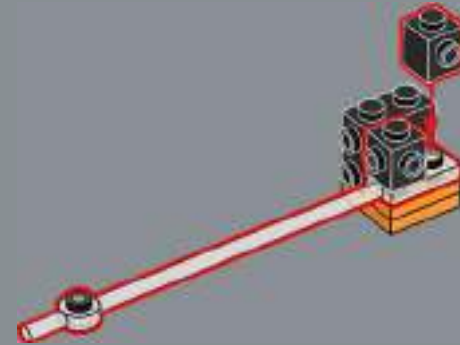

19

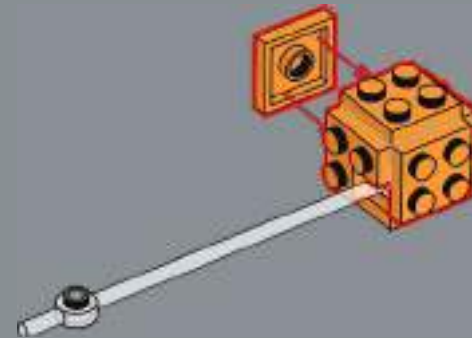

3x

20

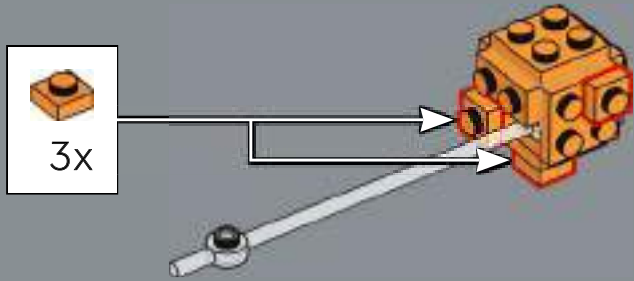

3x

21

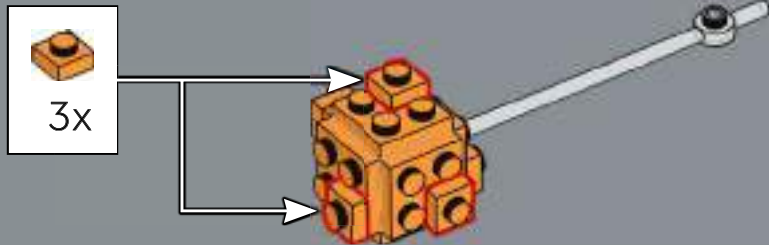

22

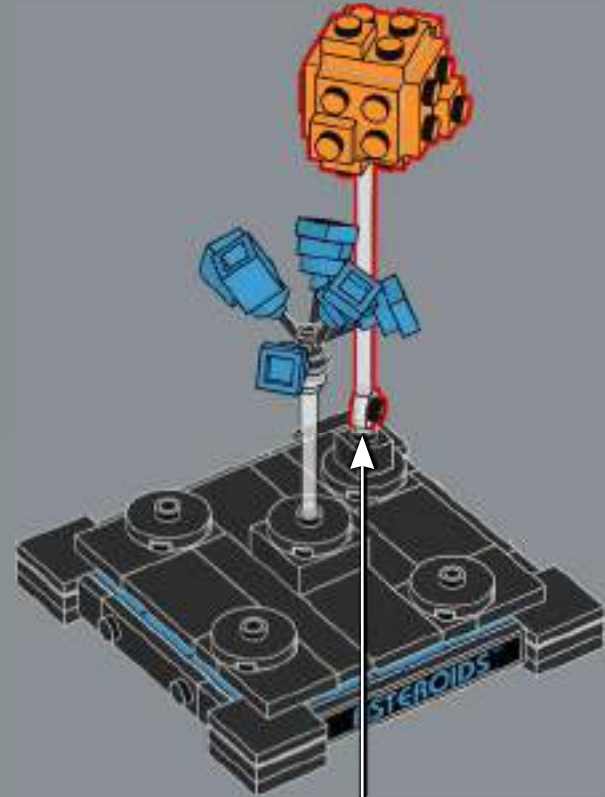

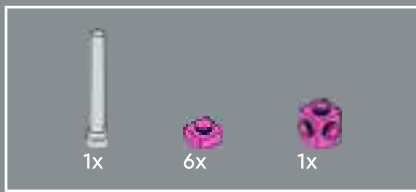

23

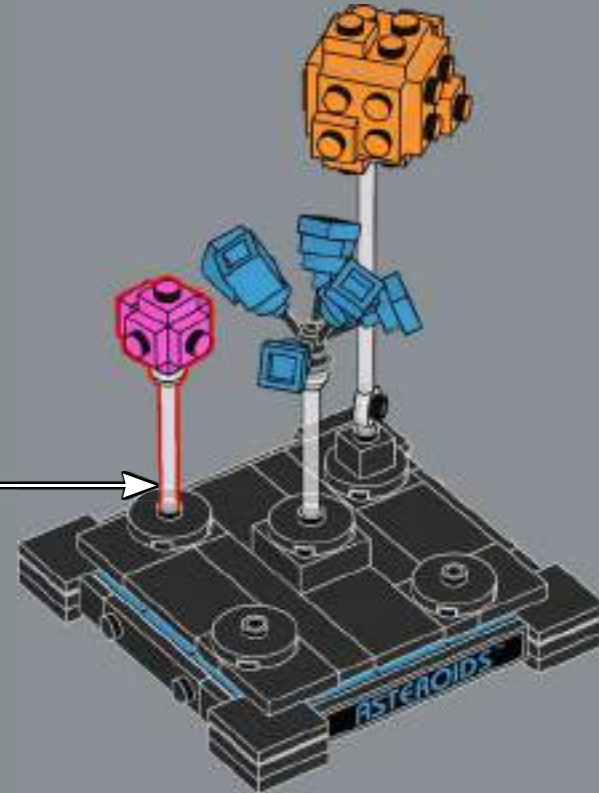
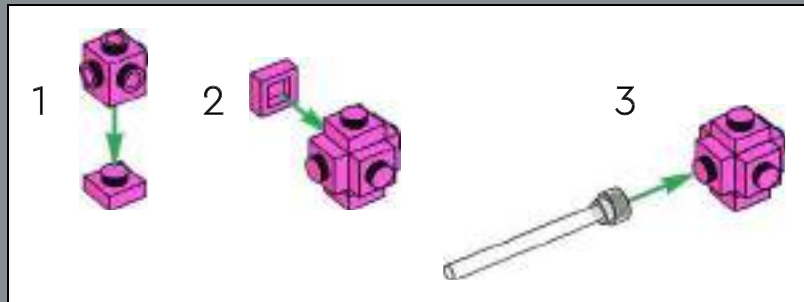



24

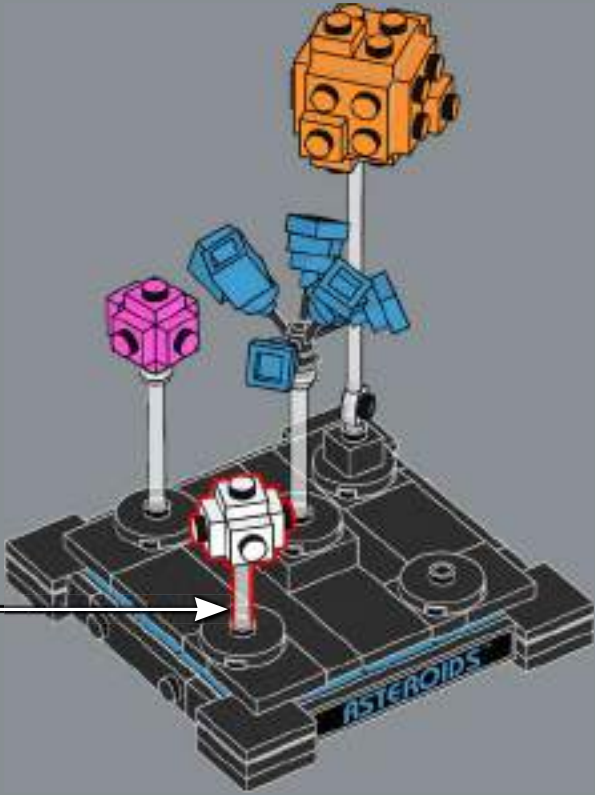
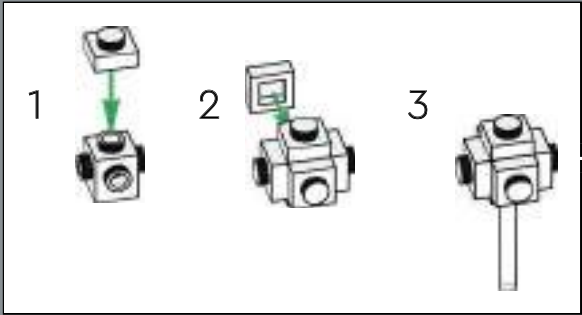



25

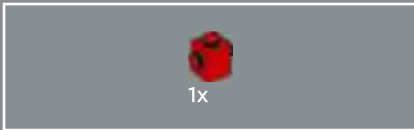

26



27



28



2x

29

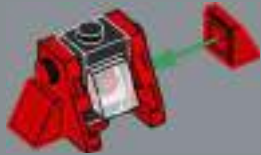

1x

1x

30



1x

31



3x

32





33



34

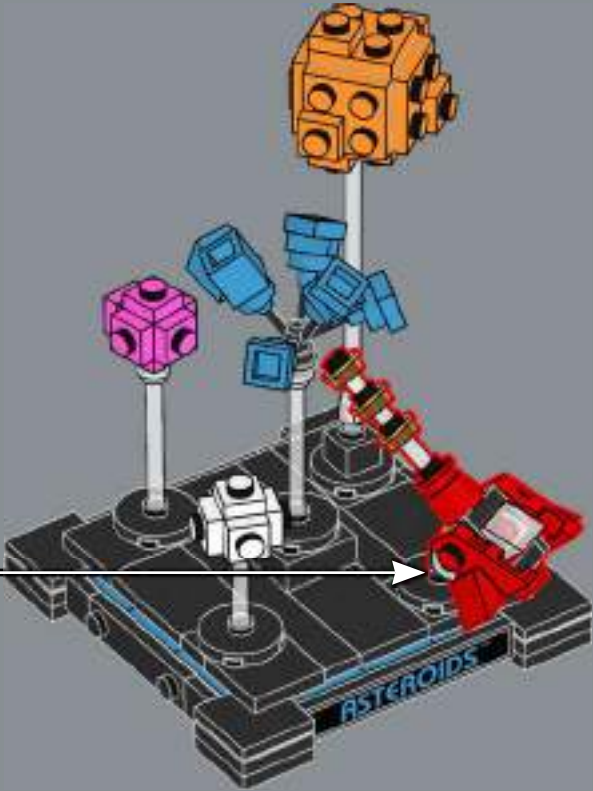

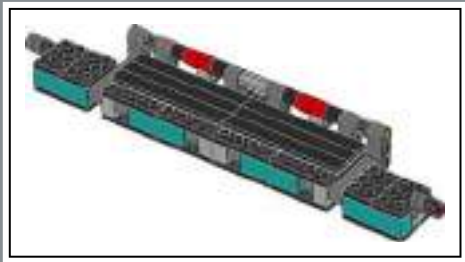

104



105



106





107

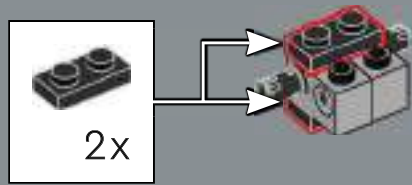

108

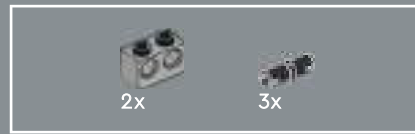
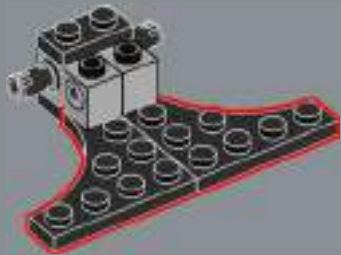

109

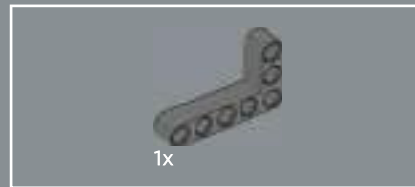
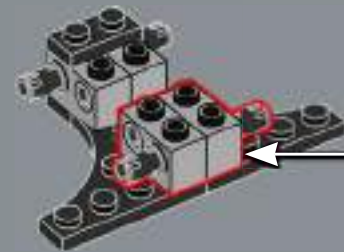
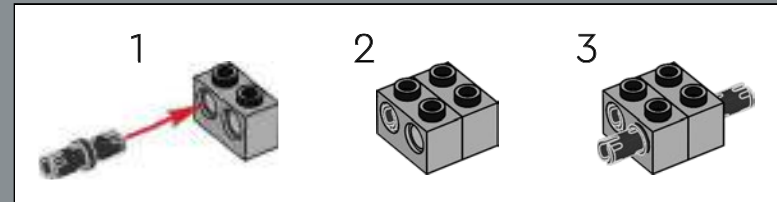

110

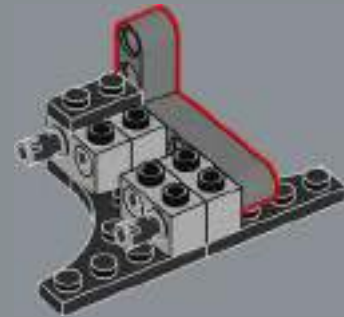

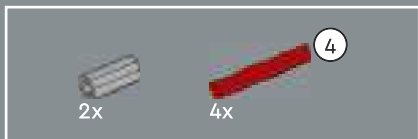

111

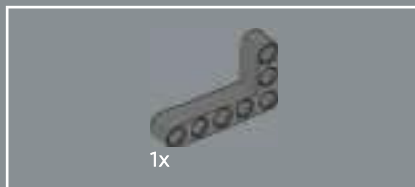
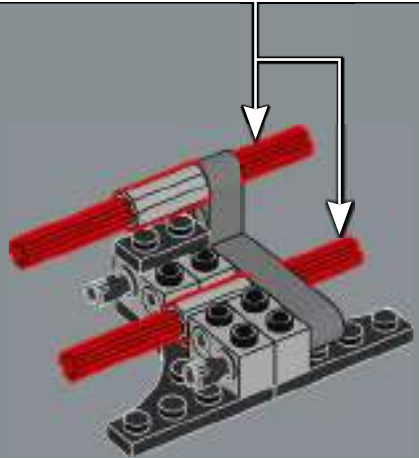
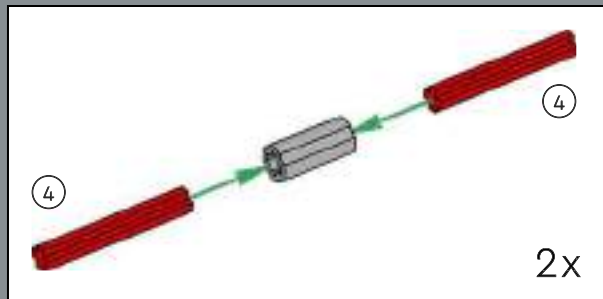

112

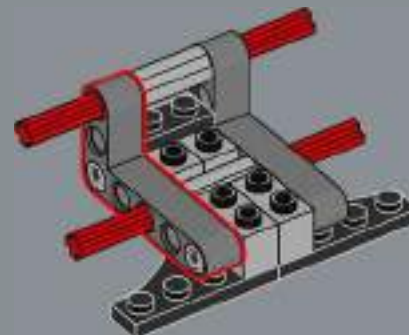

113

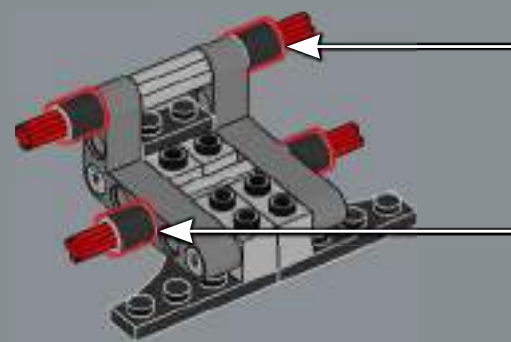



114

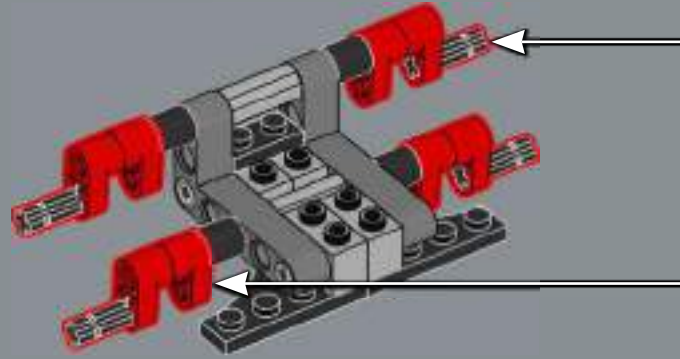
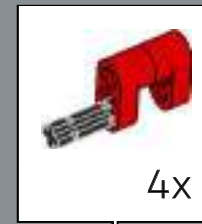

115

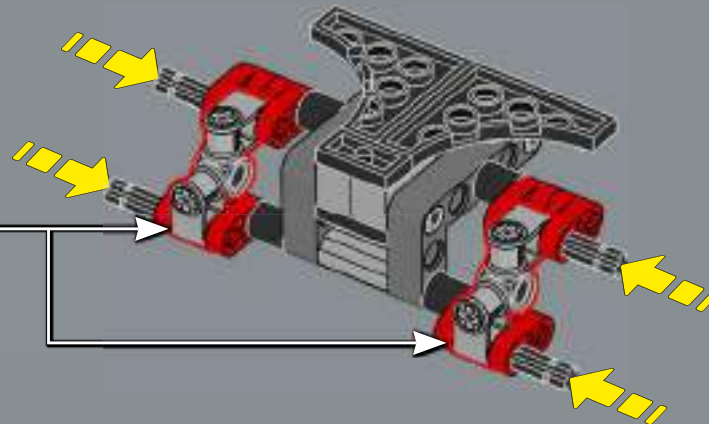
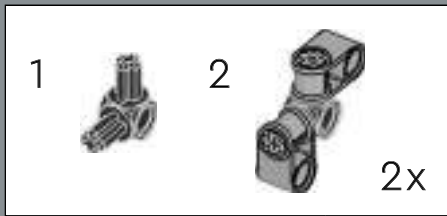

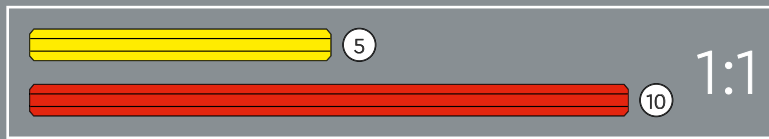
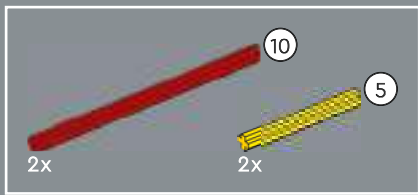

116

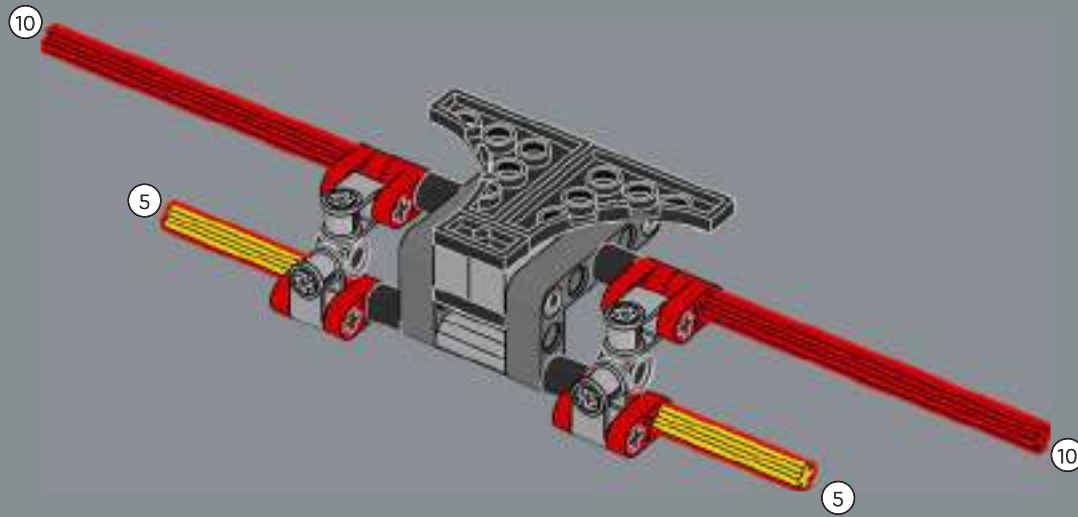



117

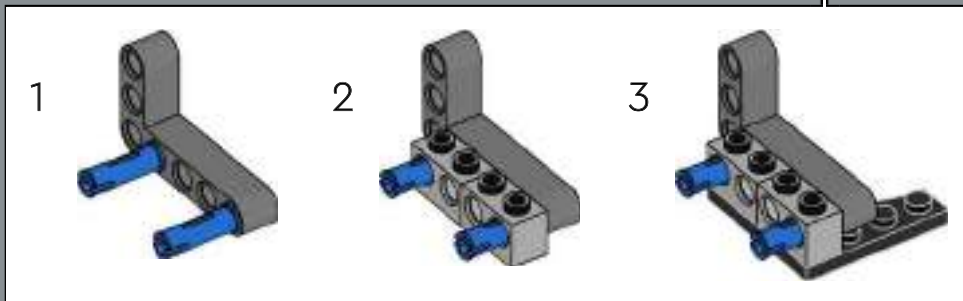
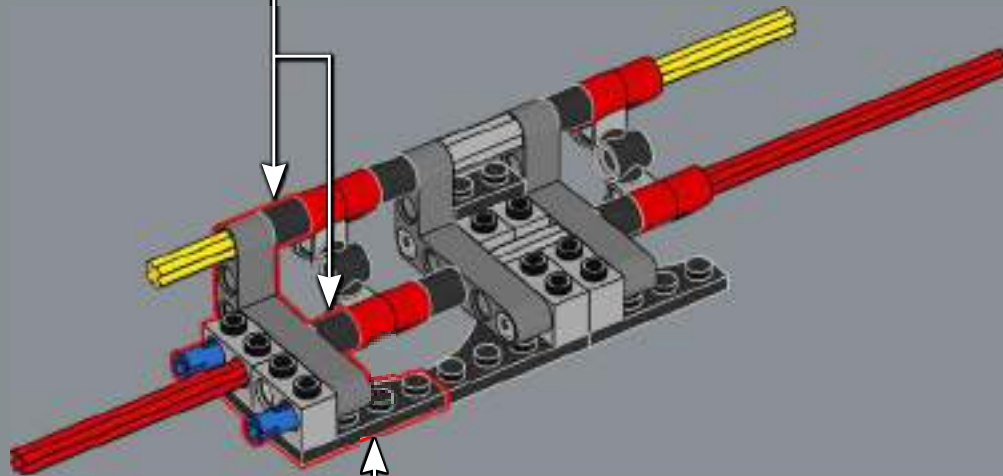



118

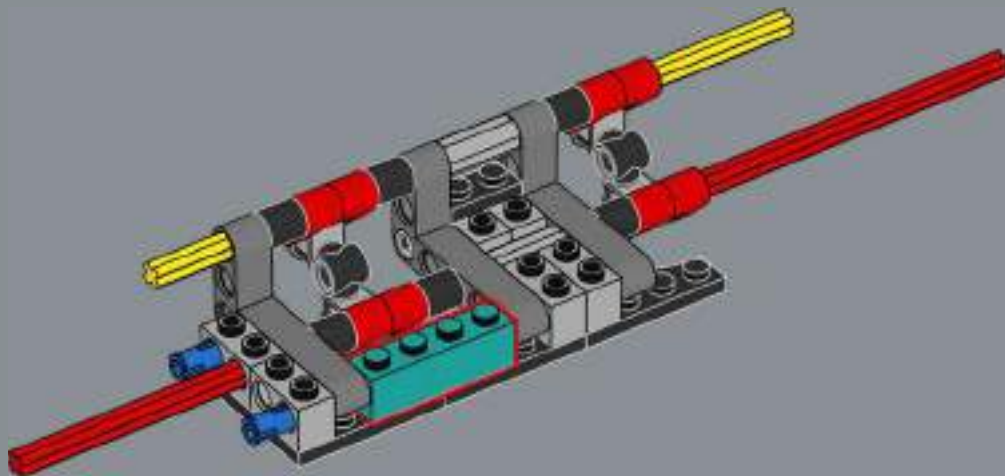



119

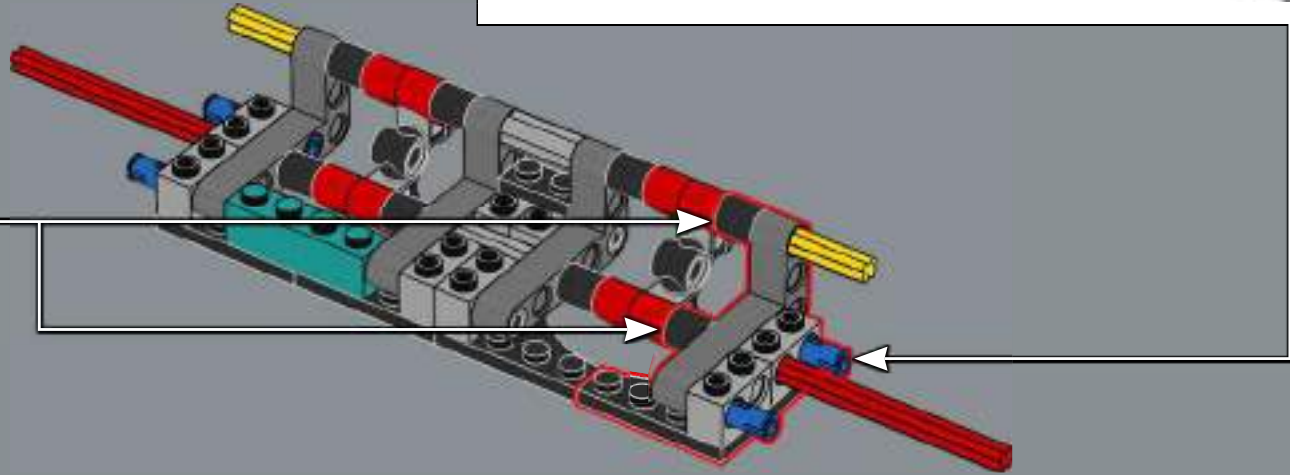
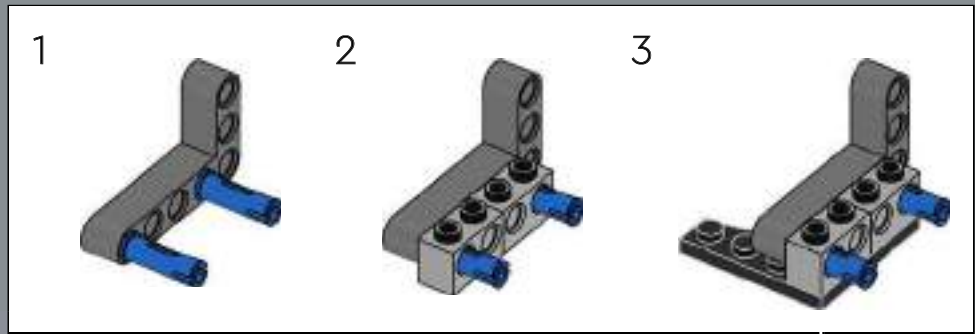

120

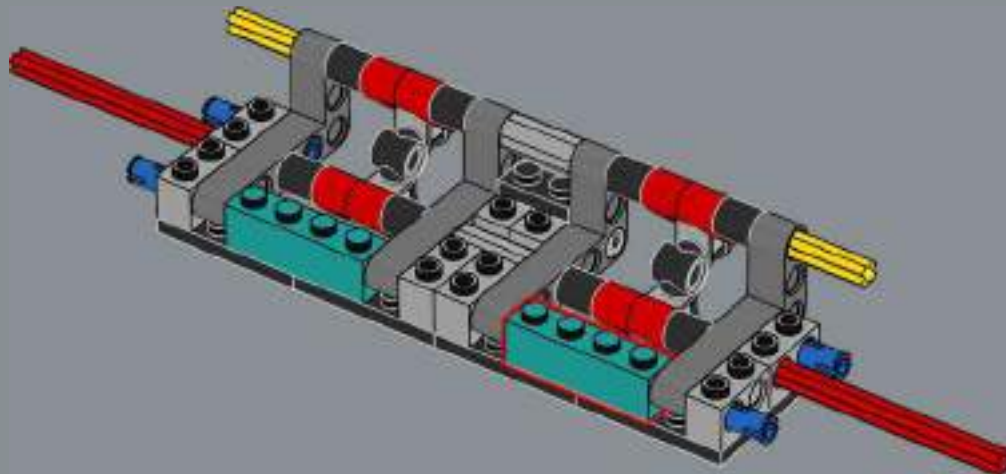



121

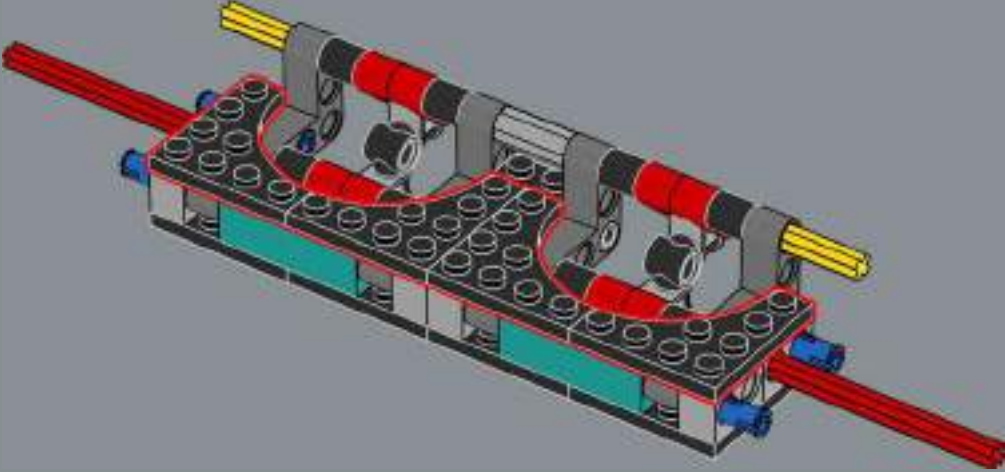

122

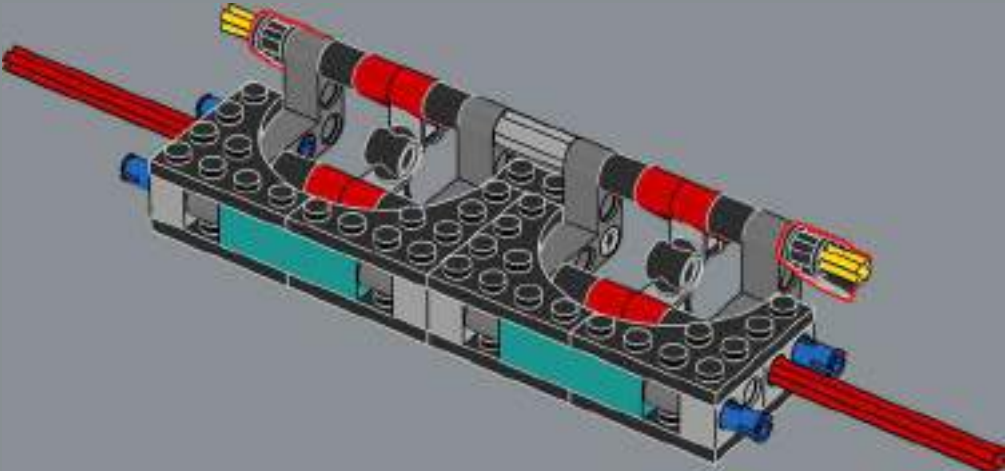



123

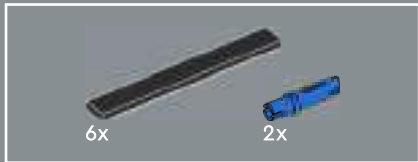
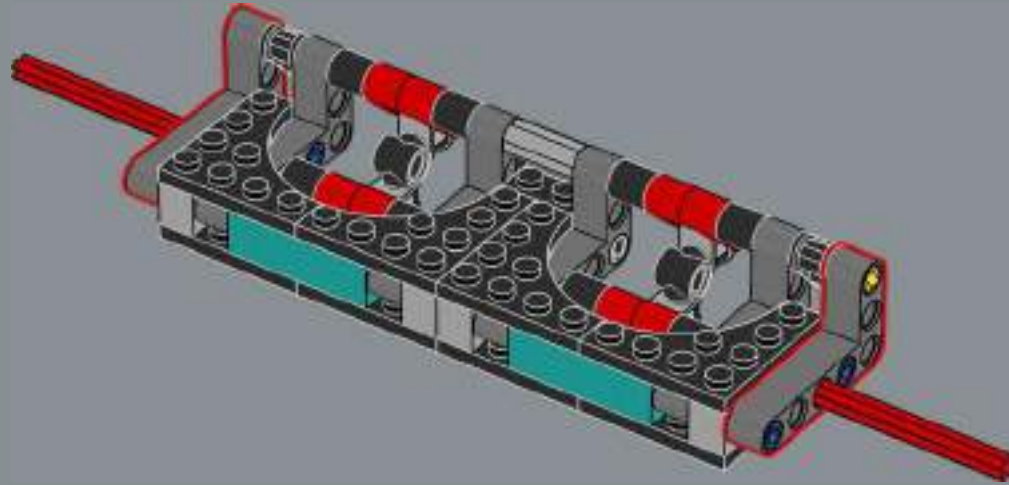

124

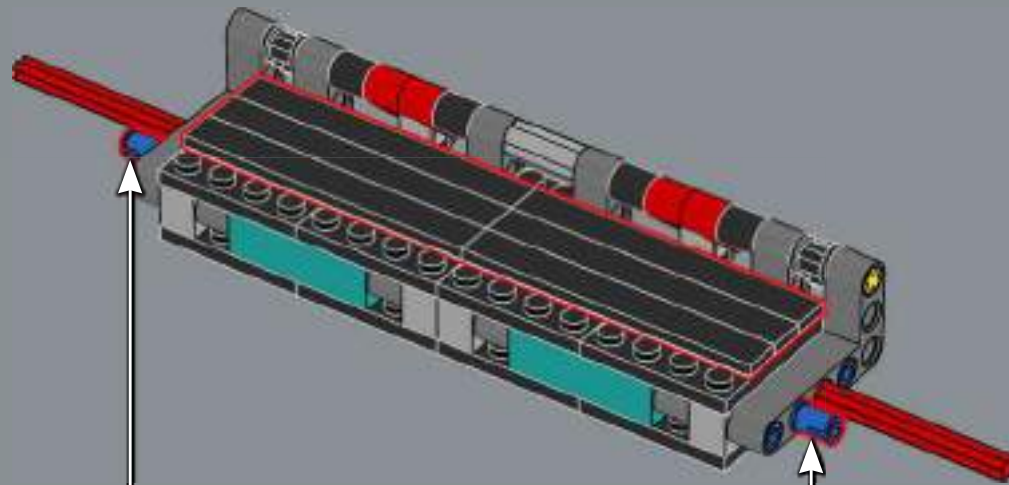

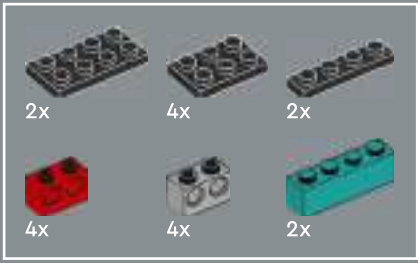

125

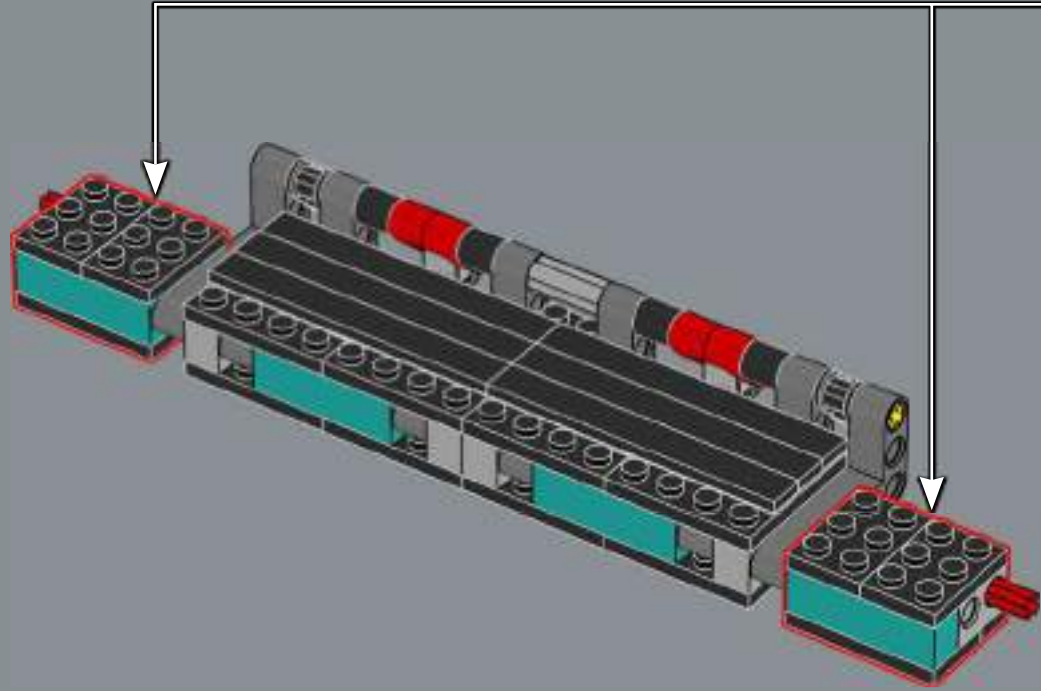
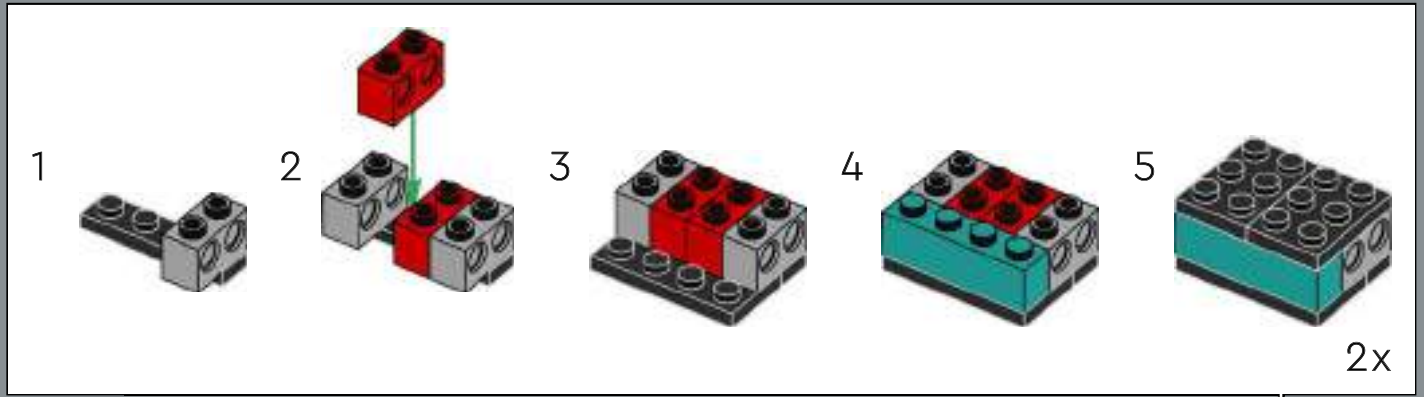



126

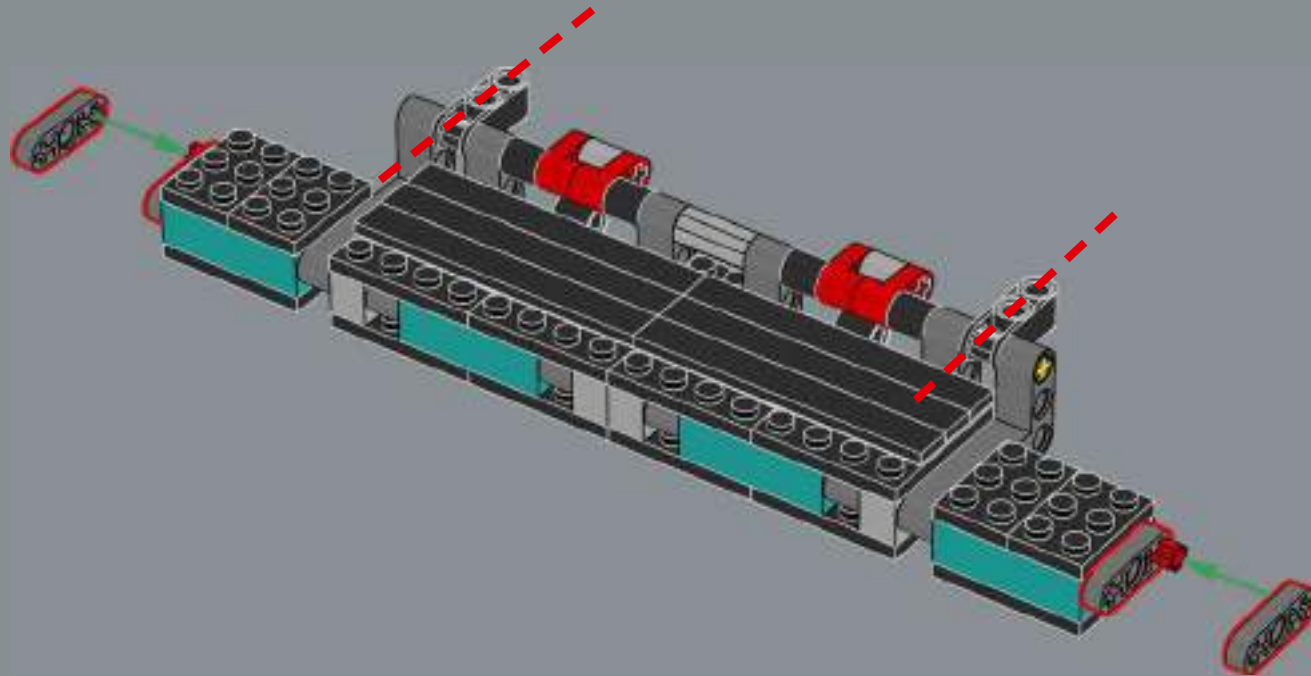

127

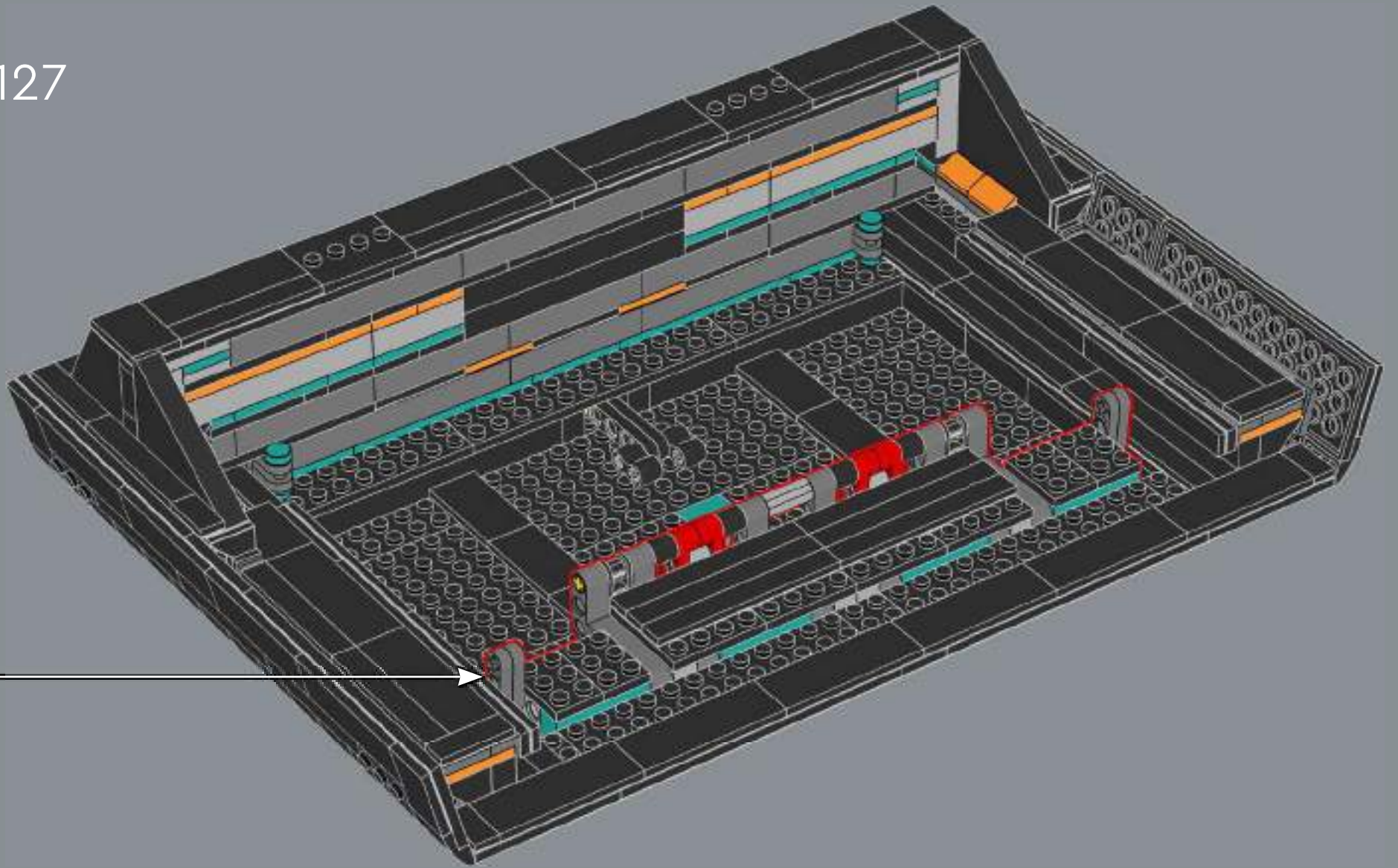



128

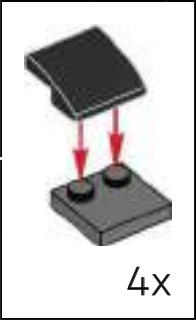
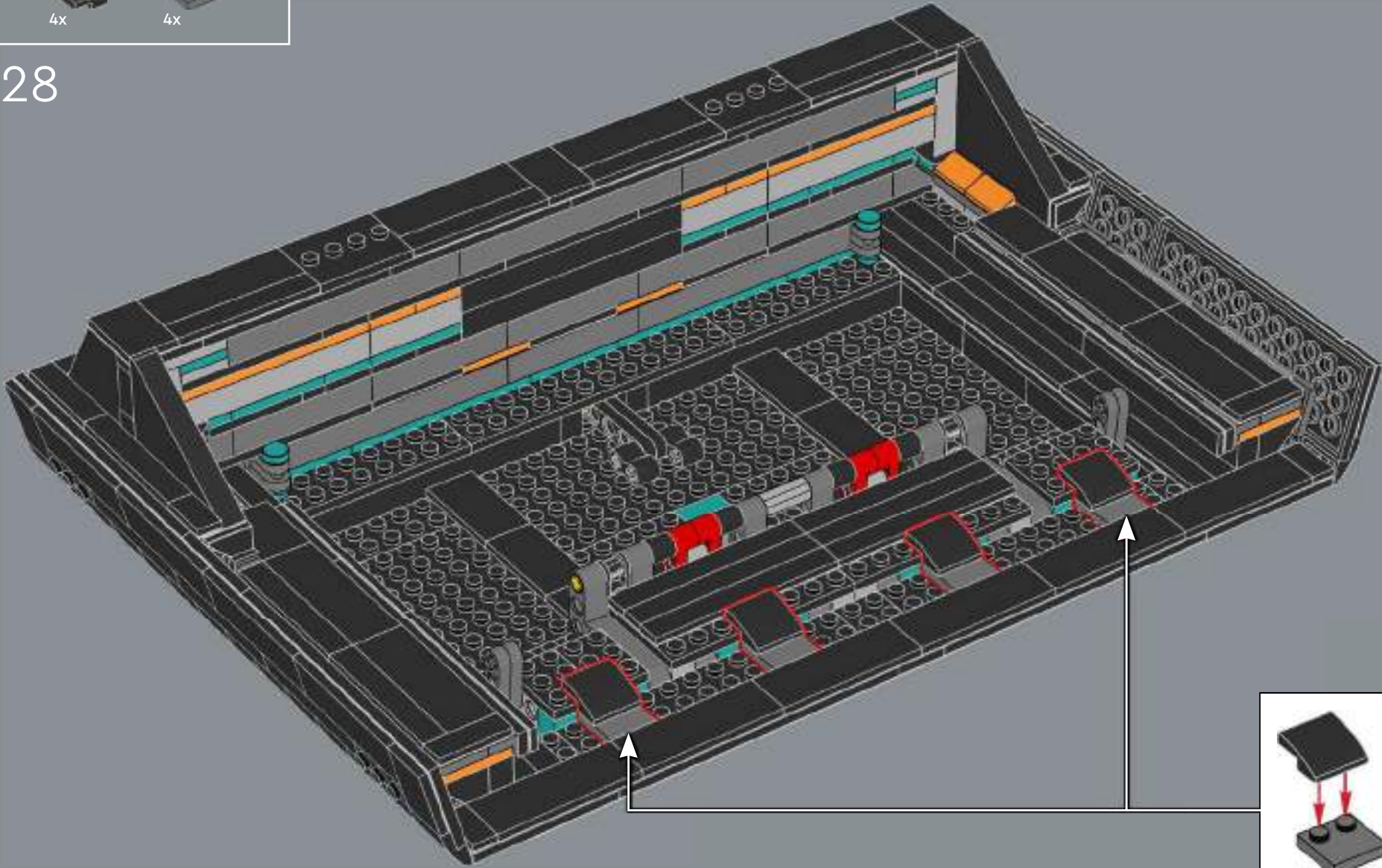



4x

129

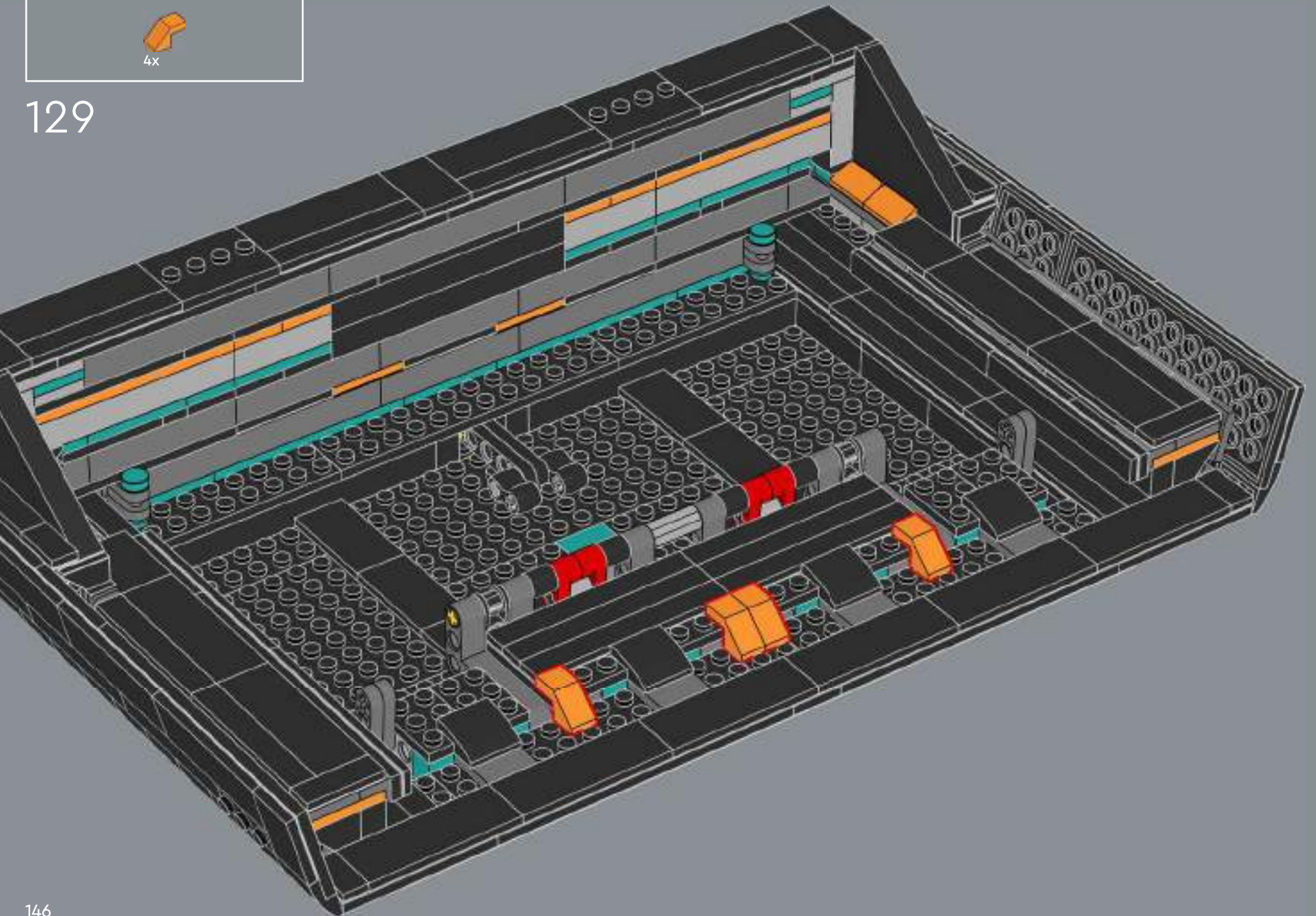

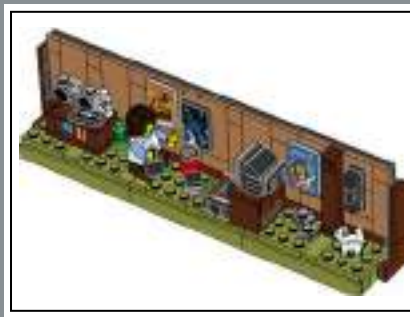

1x

130

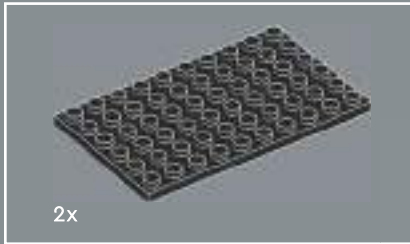

2x

131

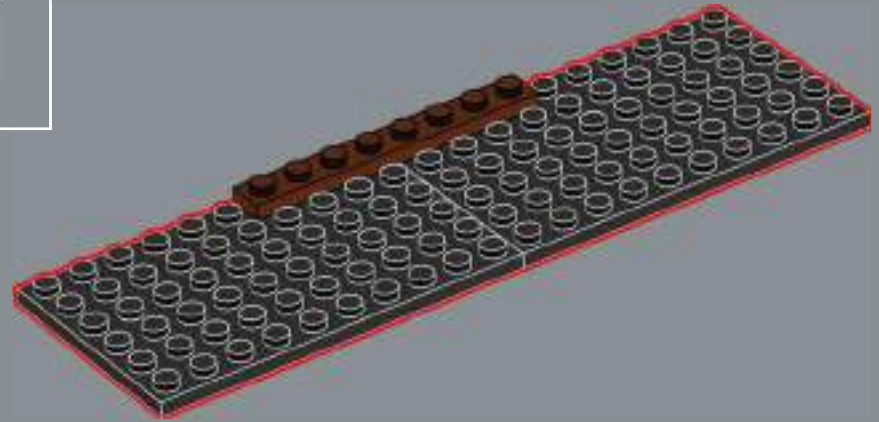



132

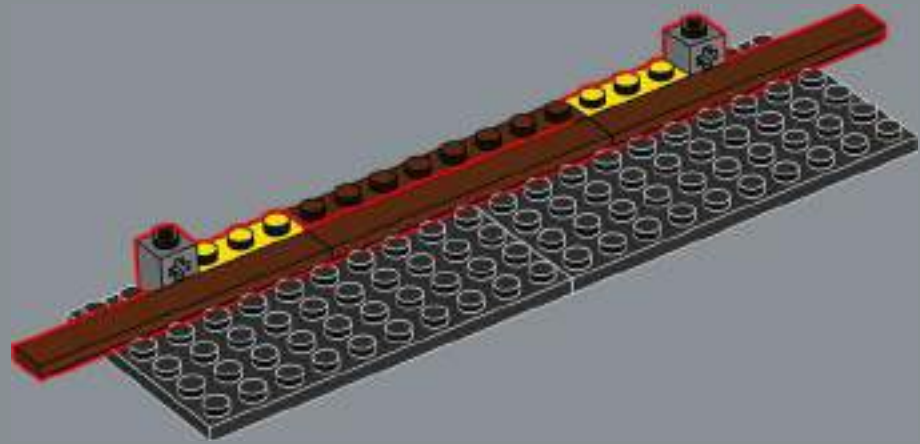

133

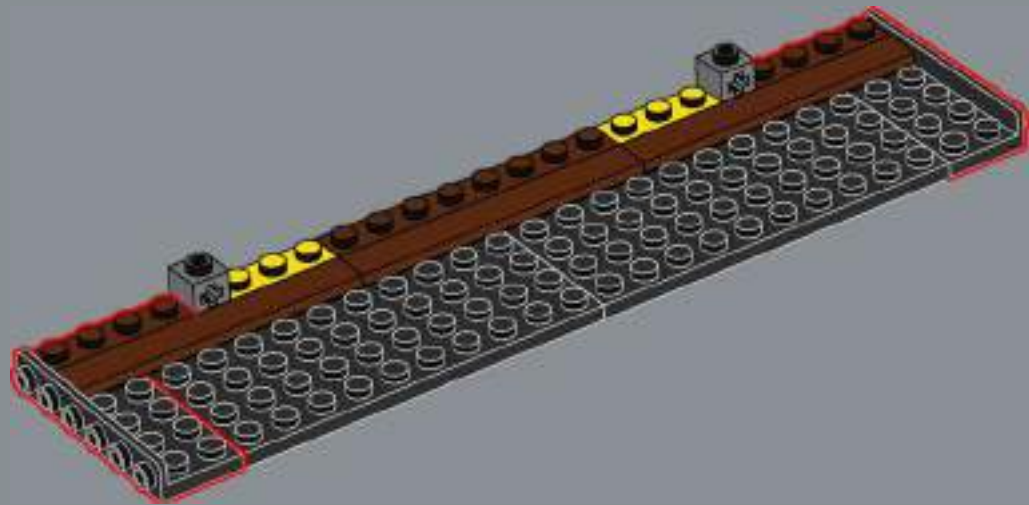

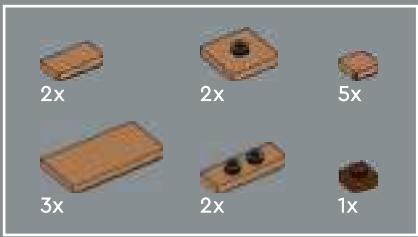

136

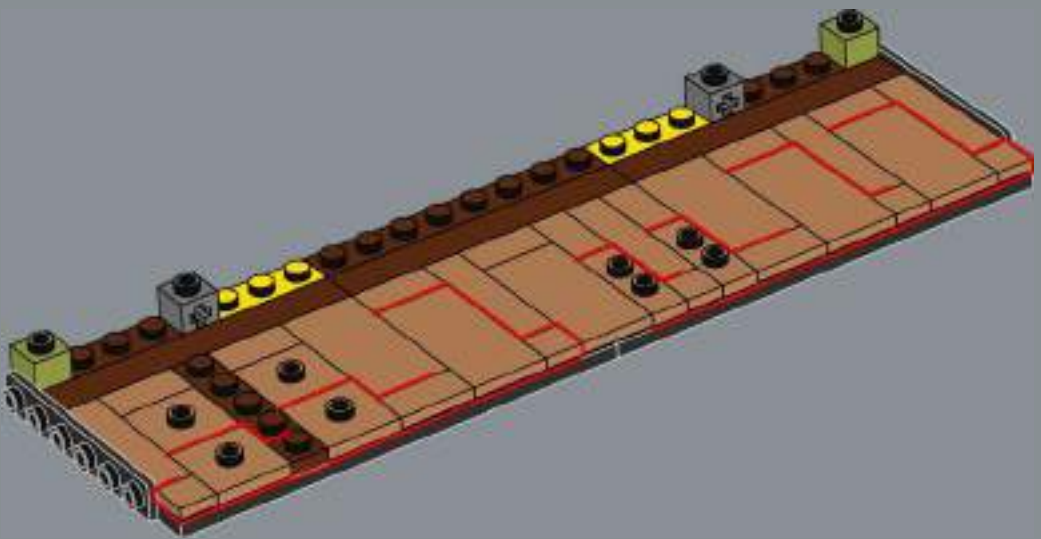

137

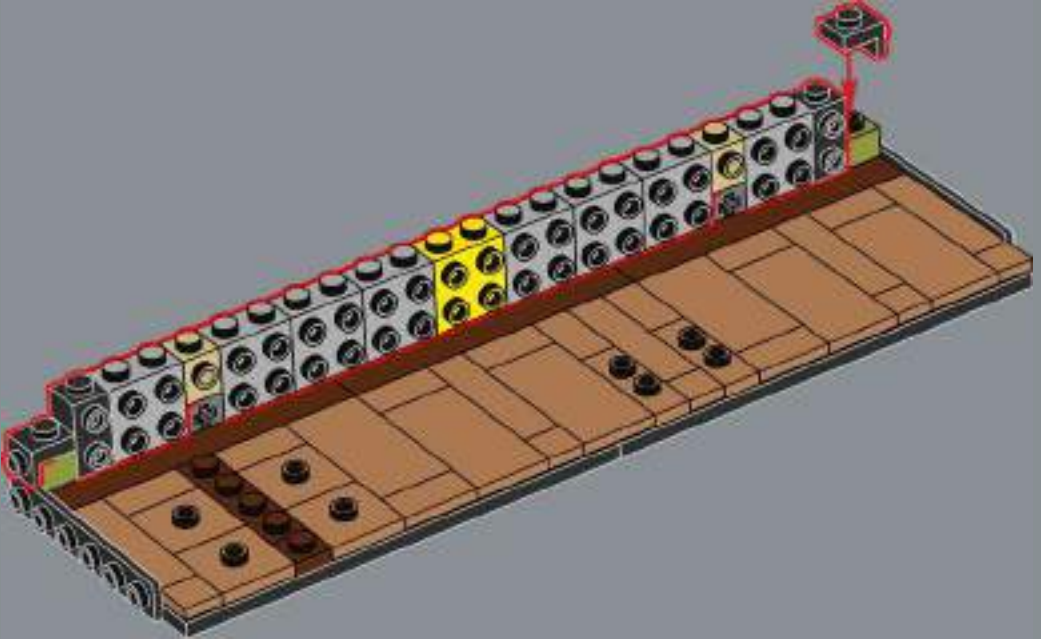



138

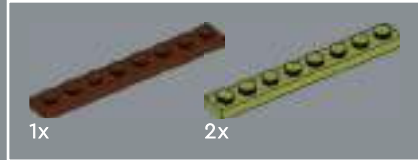
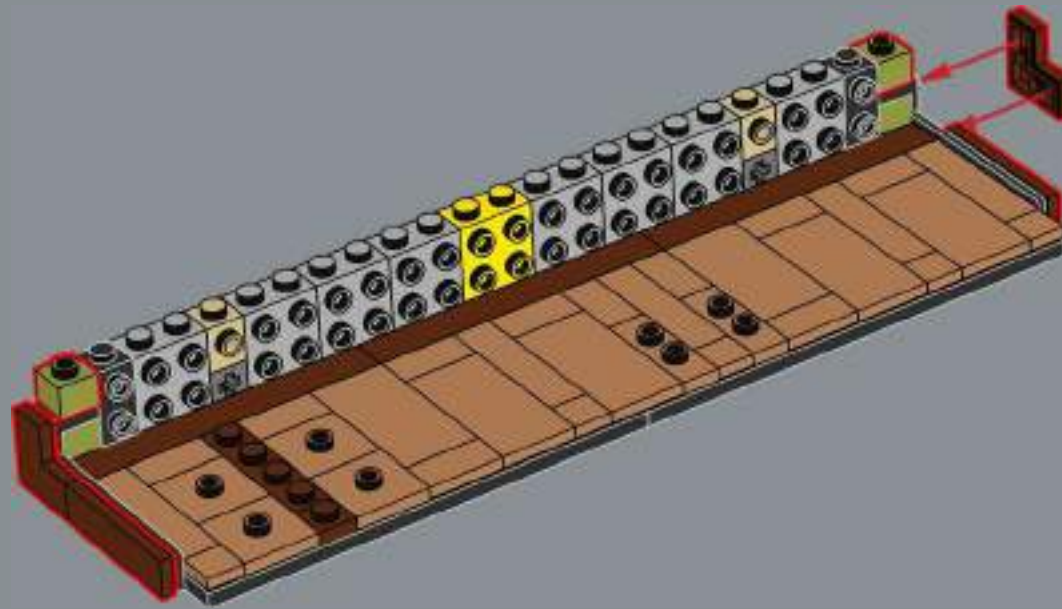

139

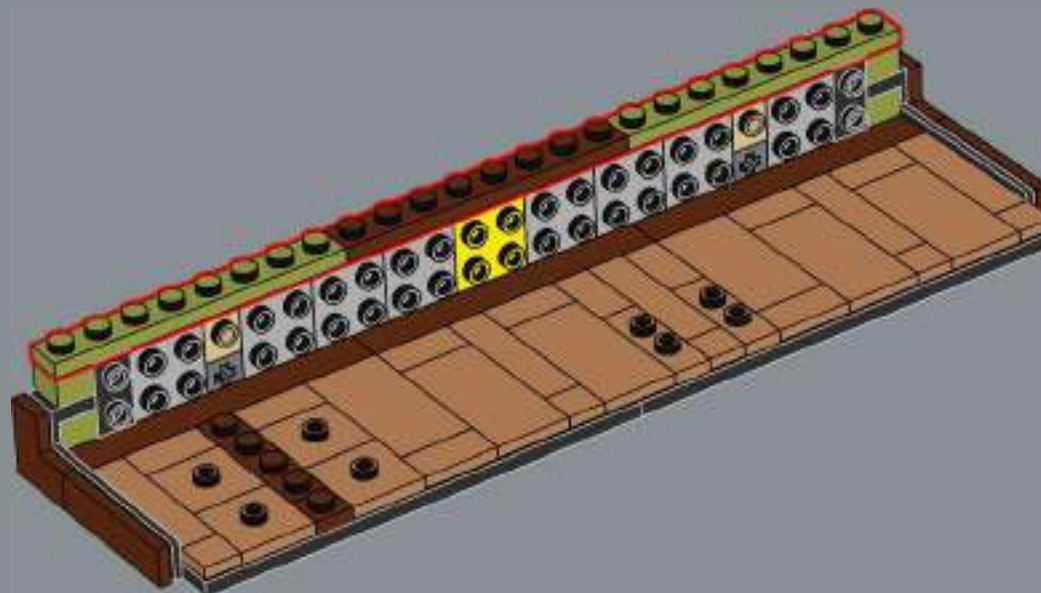



140

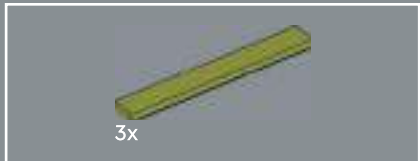
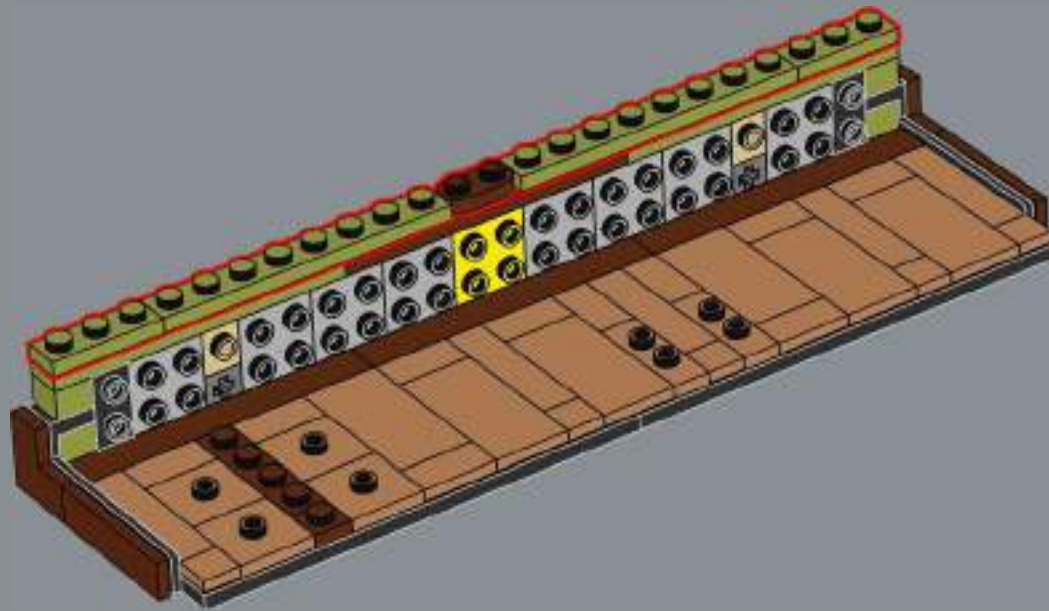

141

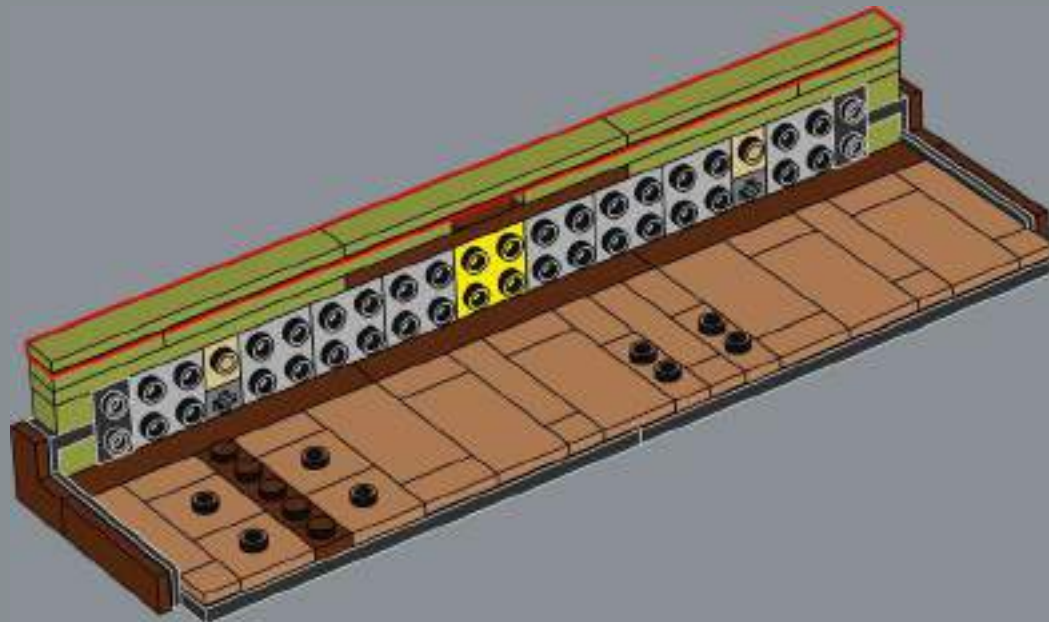

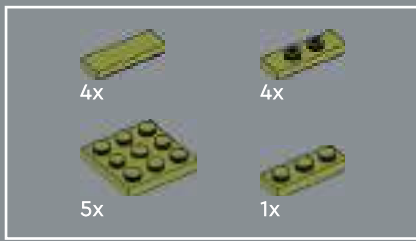

142

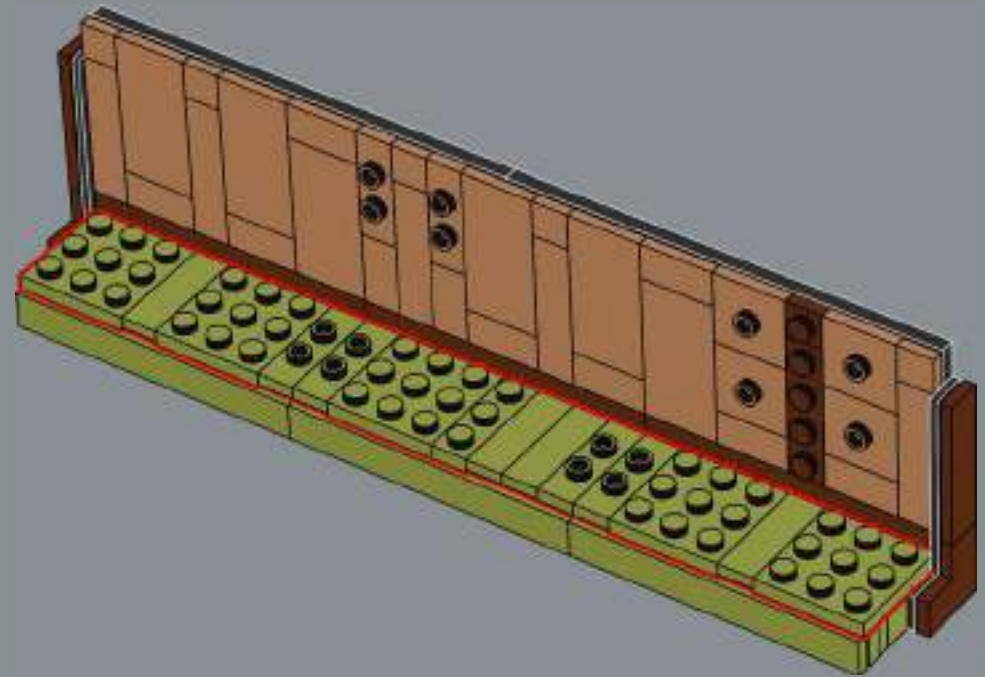

143

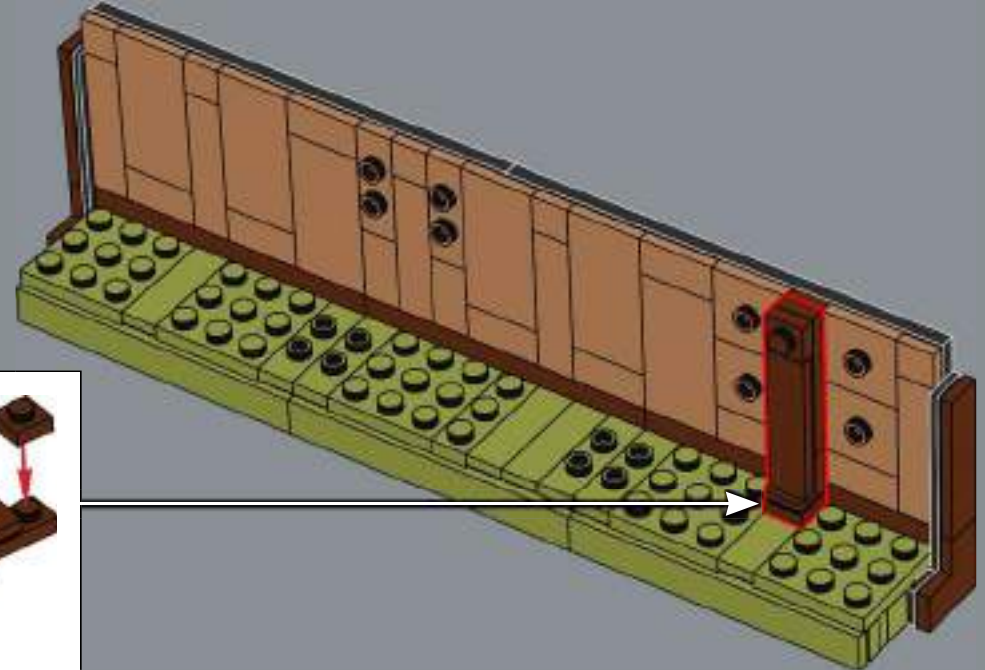

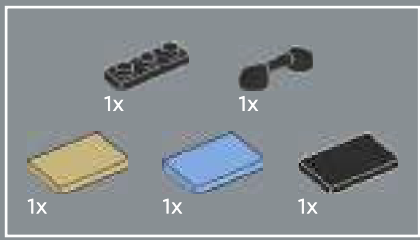

144

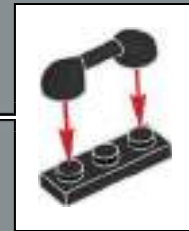
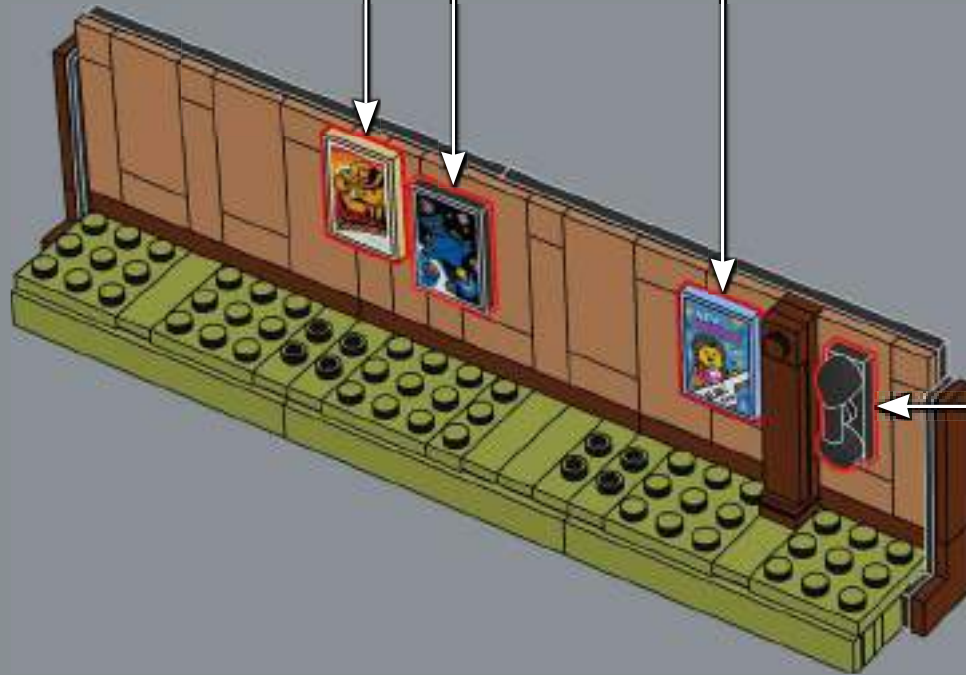



145

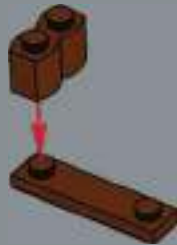

146

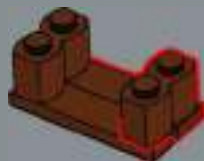

147

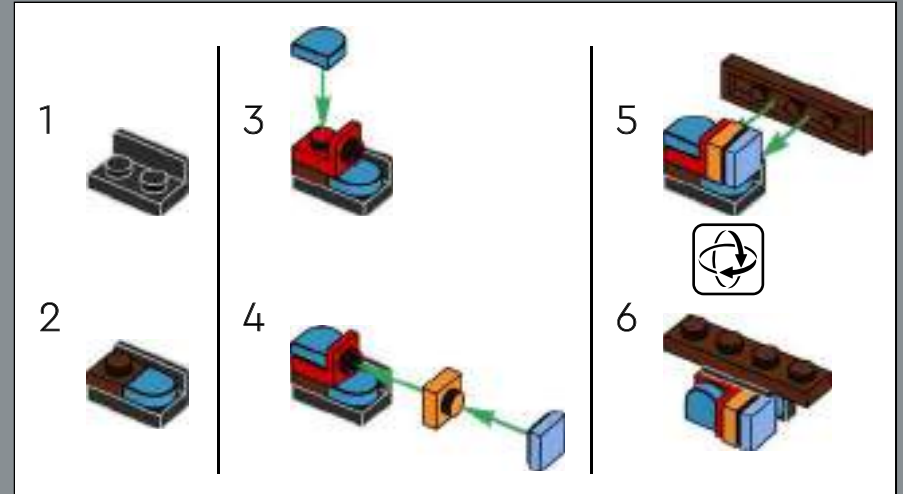



148



149



150

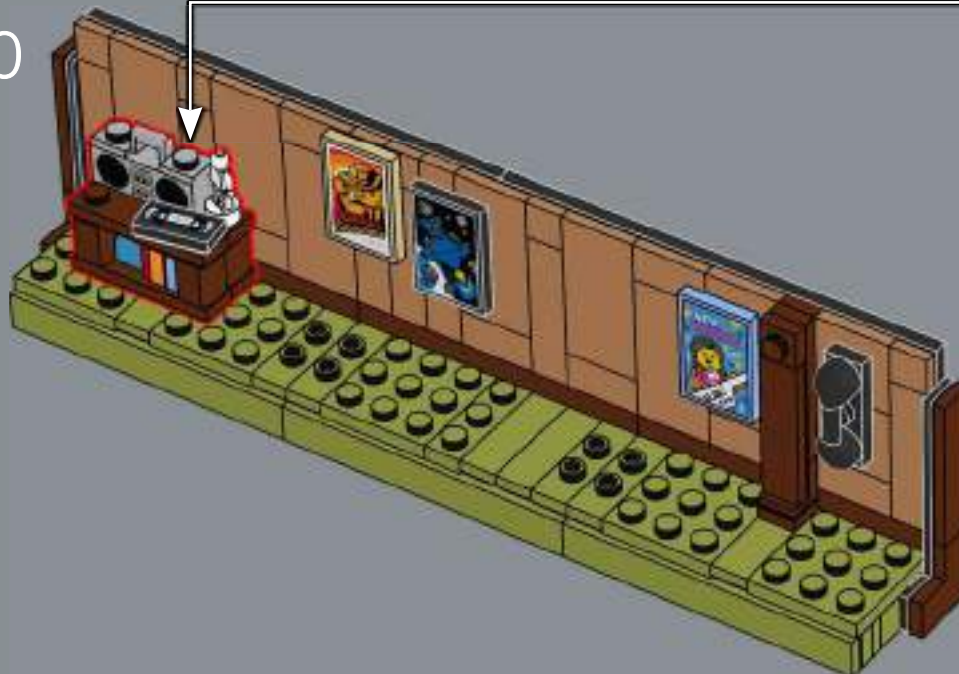

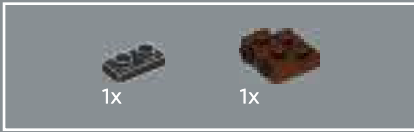

151



152

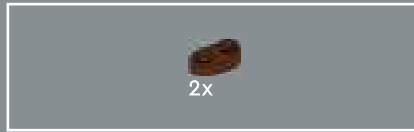

153



154



155

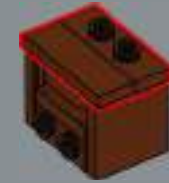

156





1x

157



1x



1x



1x

158

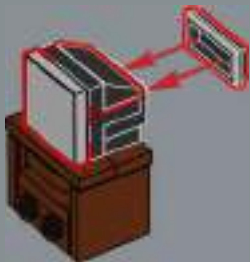

159



1x



3x



2x



1x

160

1



2



3



161

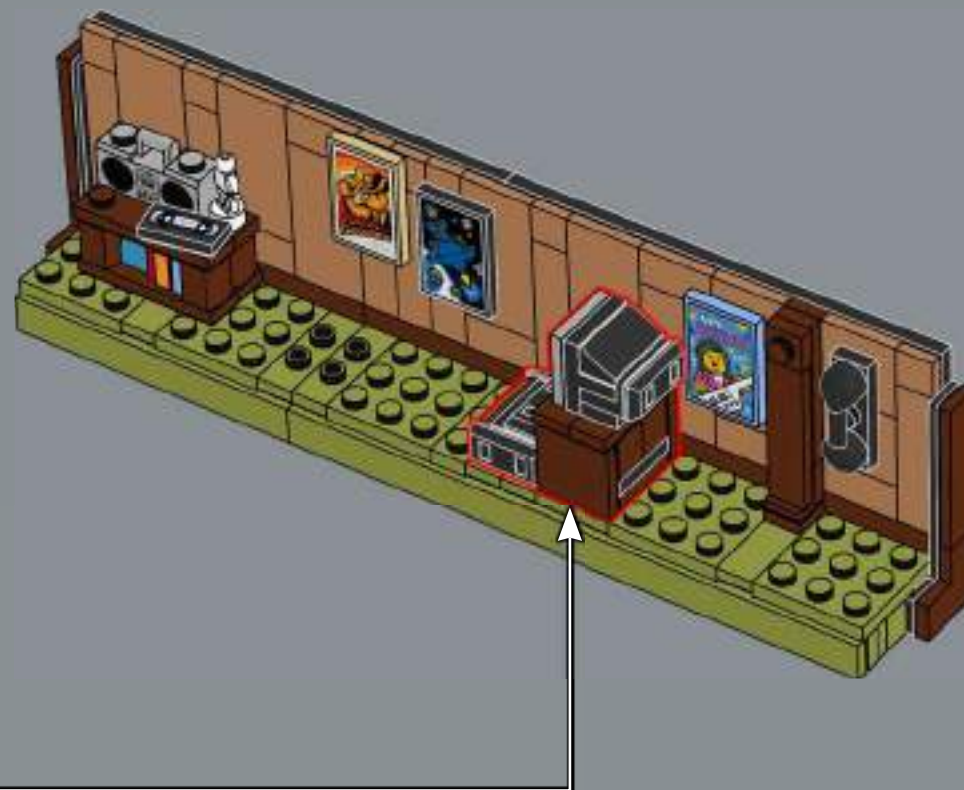



162

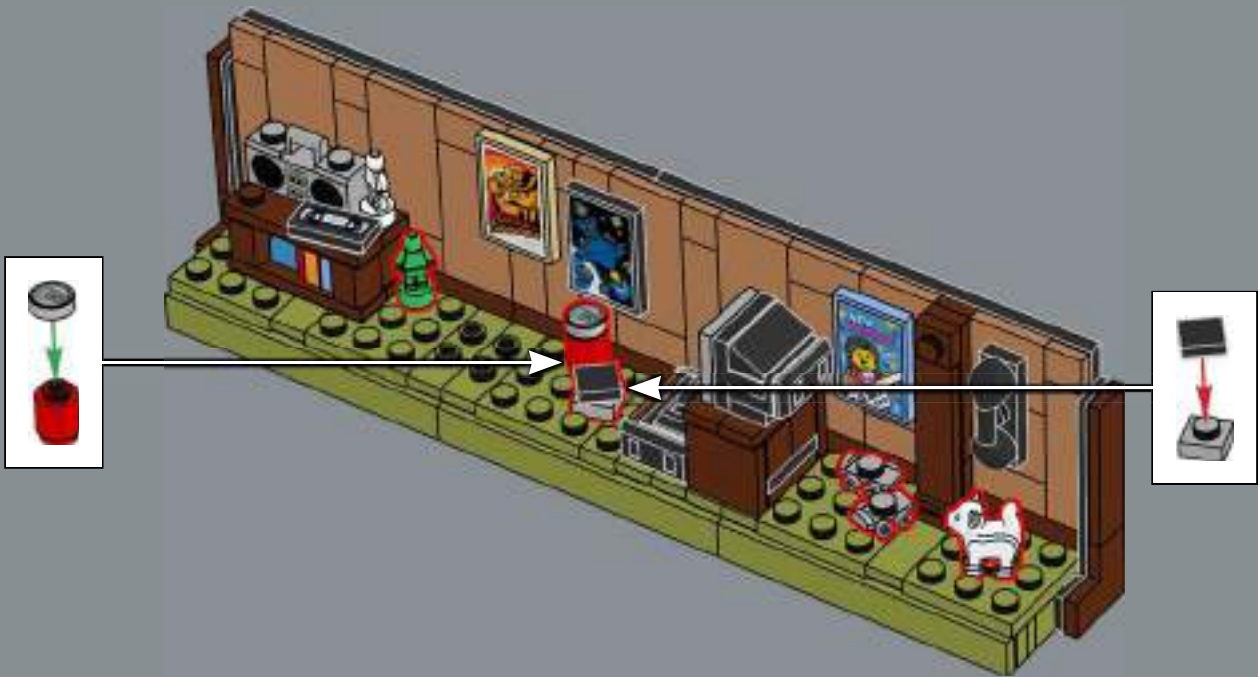

163





164

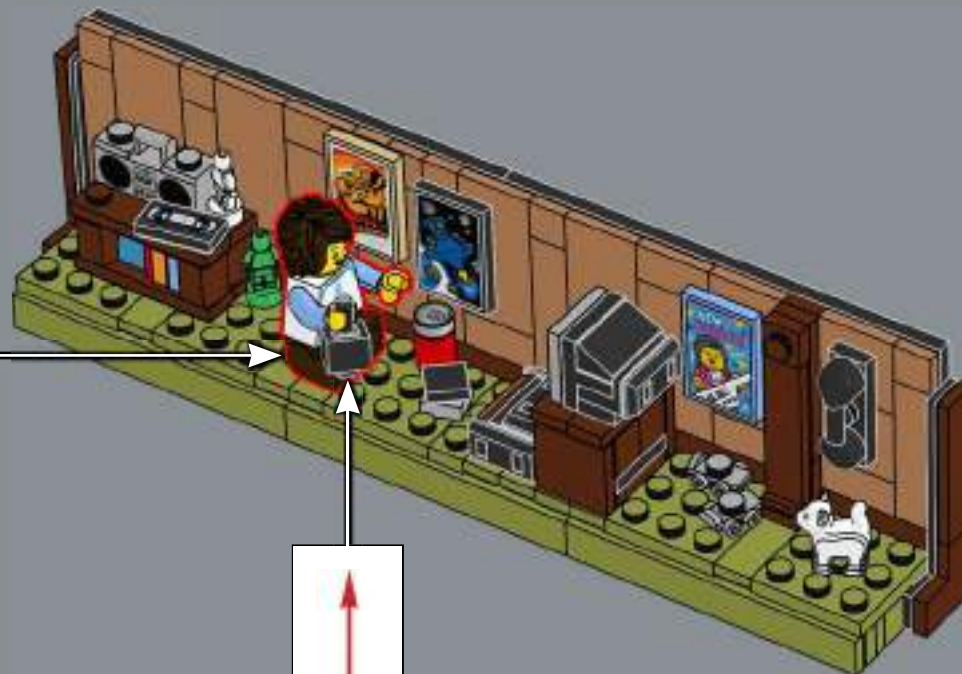

165

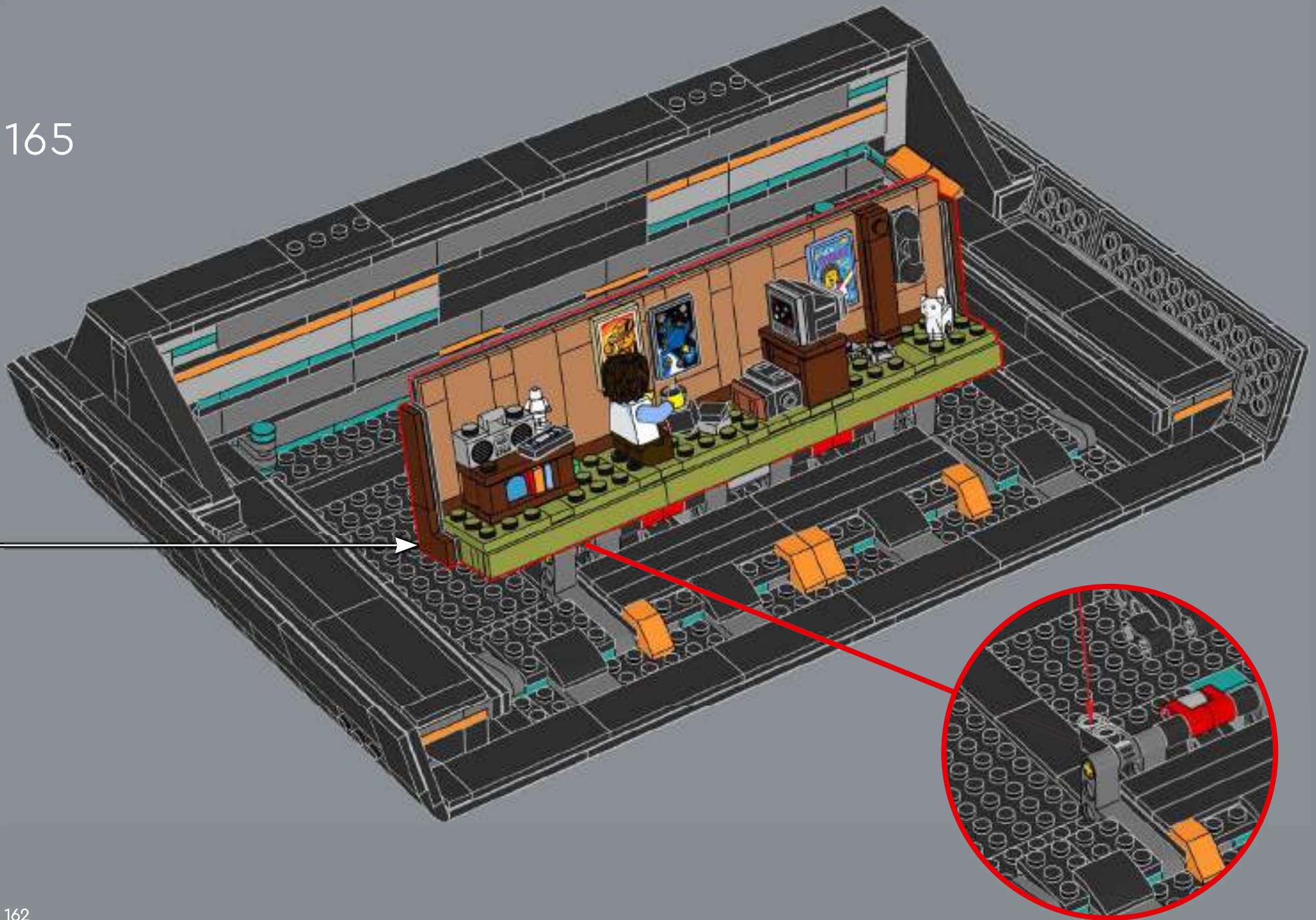

162

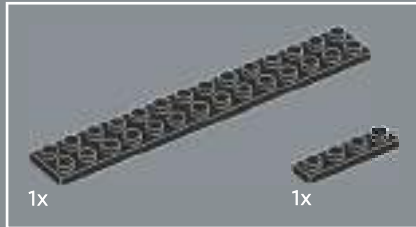
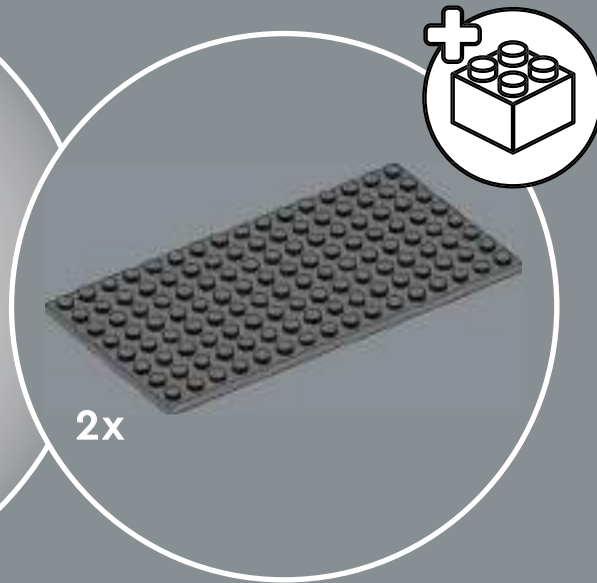

166

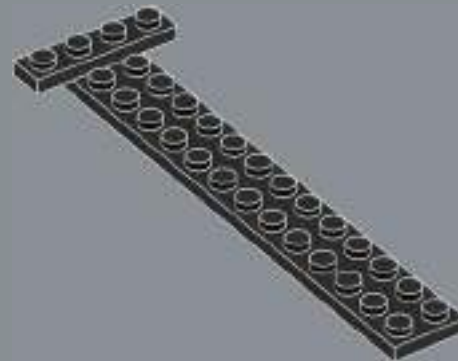



167

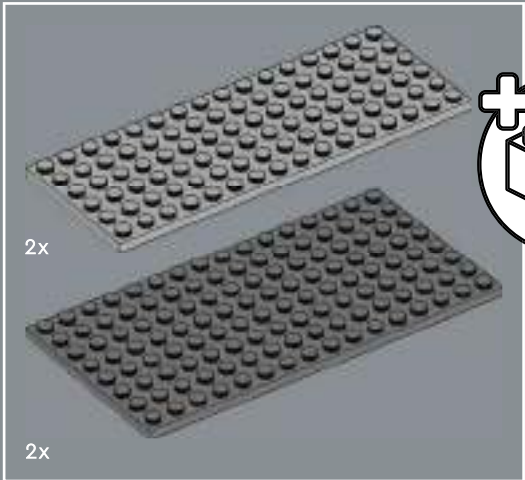
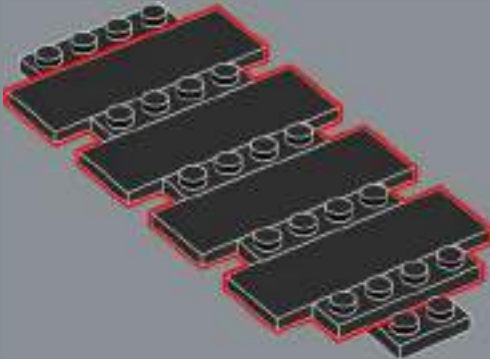

168

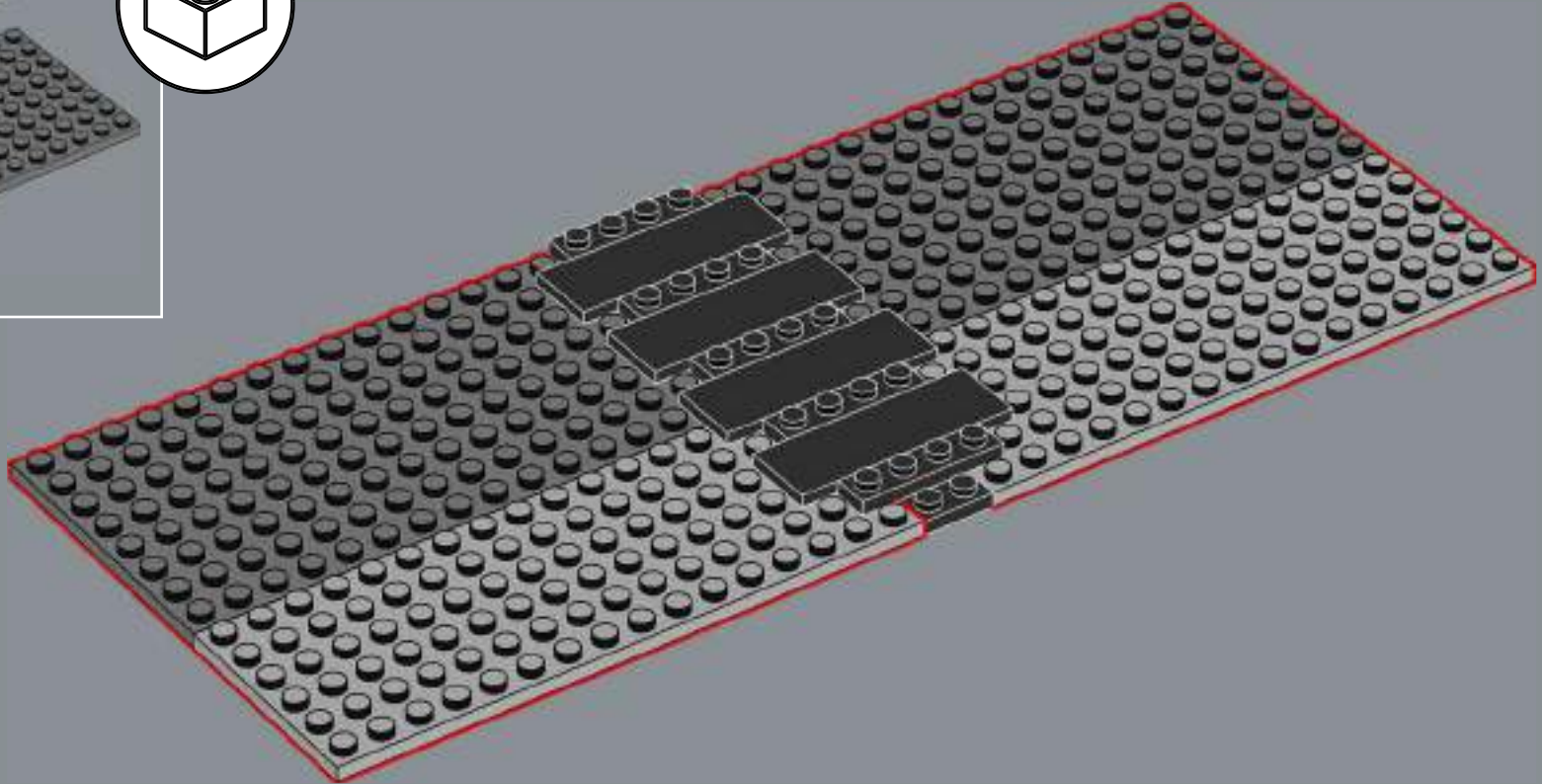

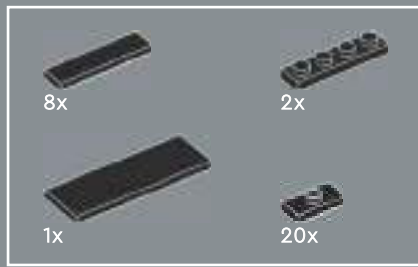

169

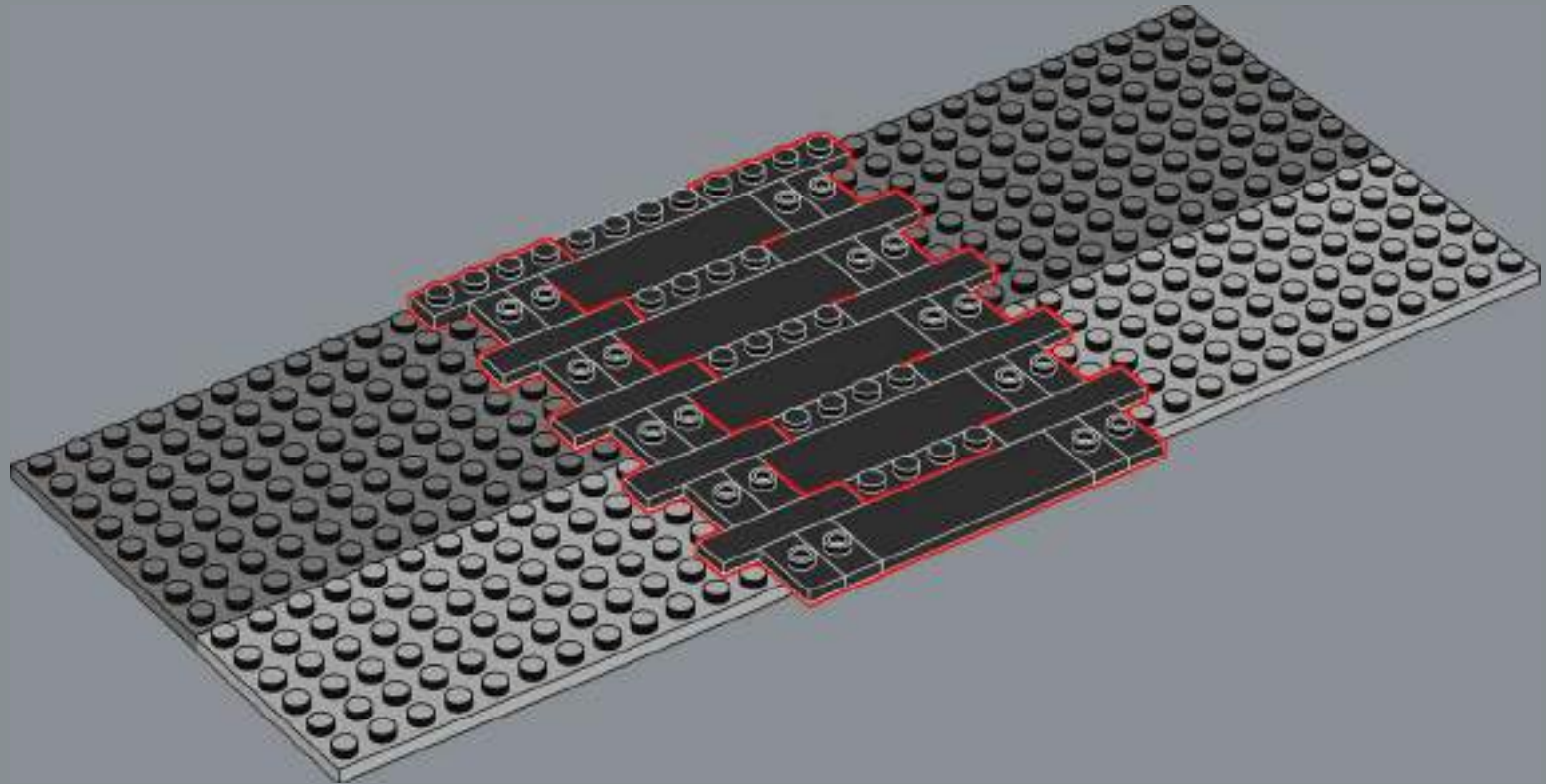

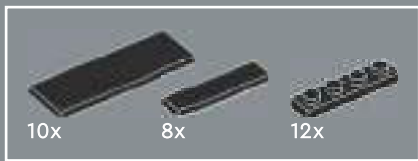

170

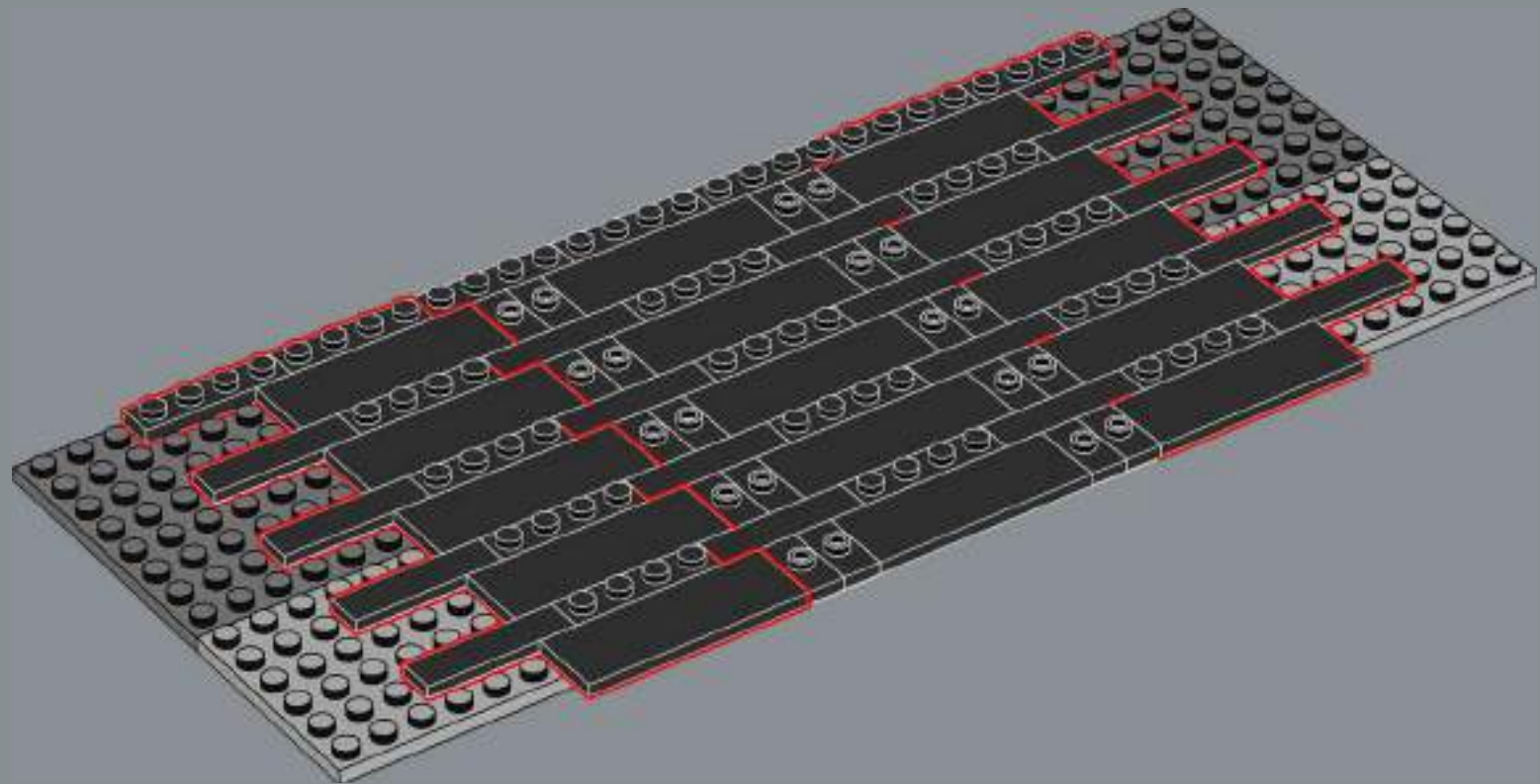



171

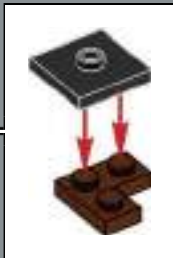
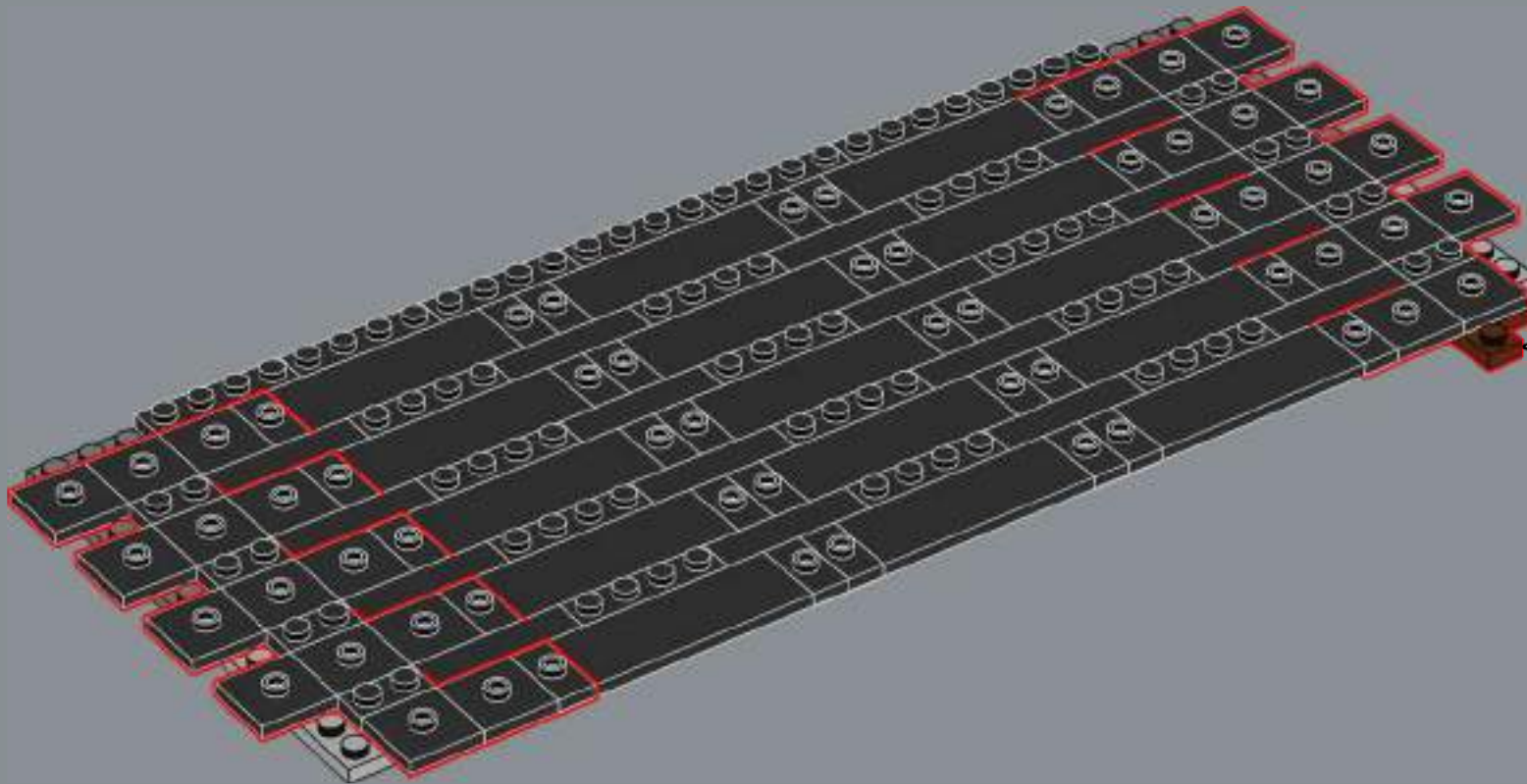

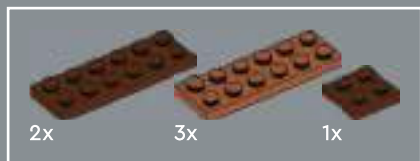

172

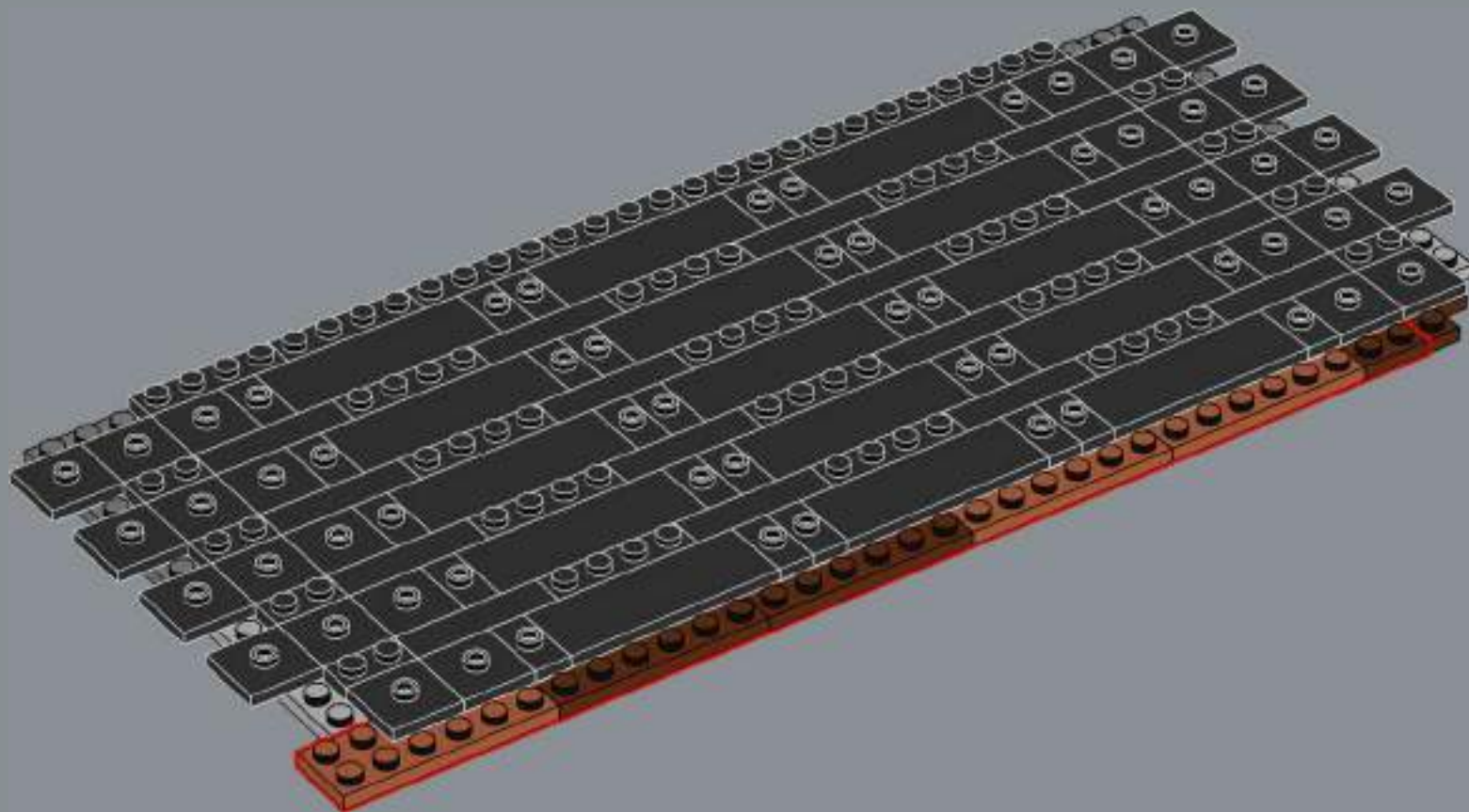

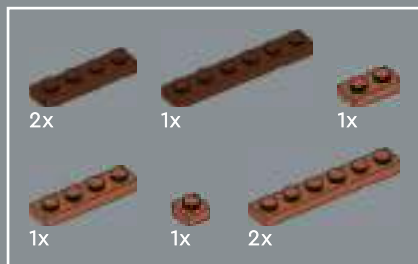

173

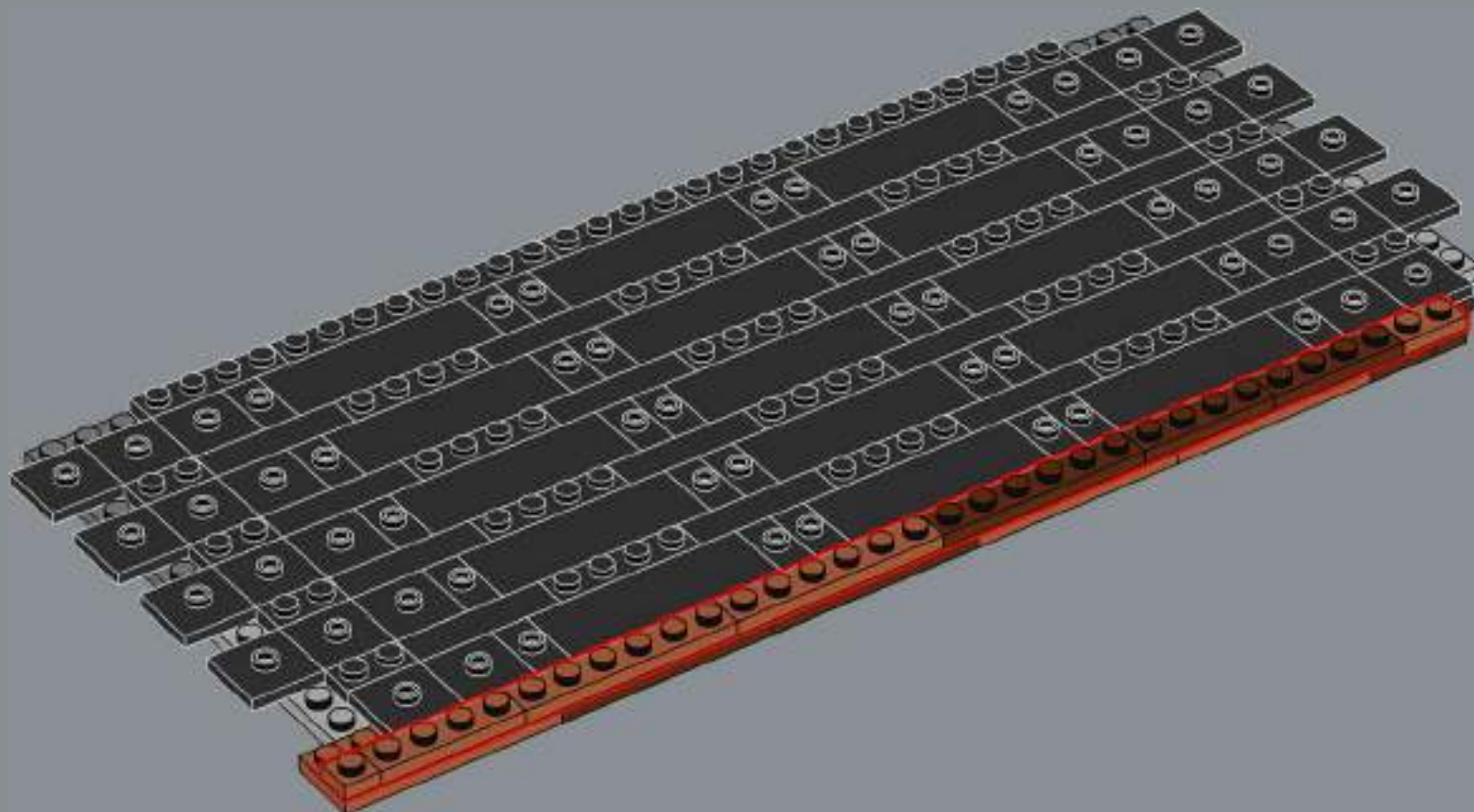



174

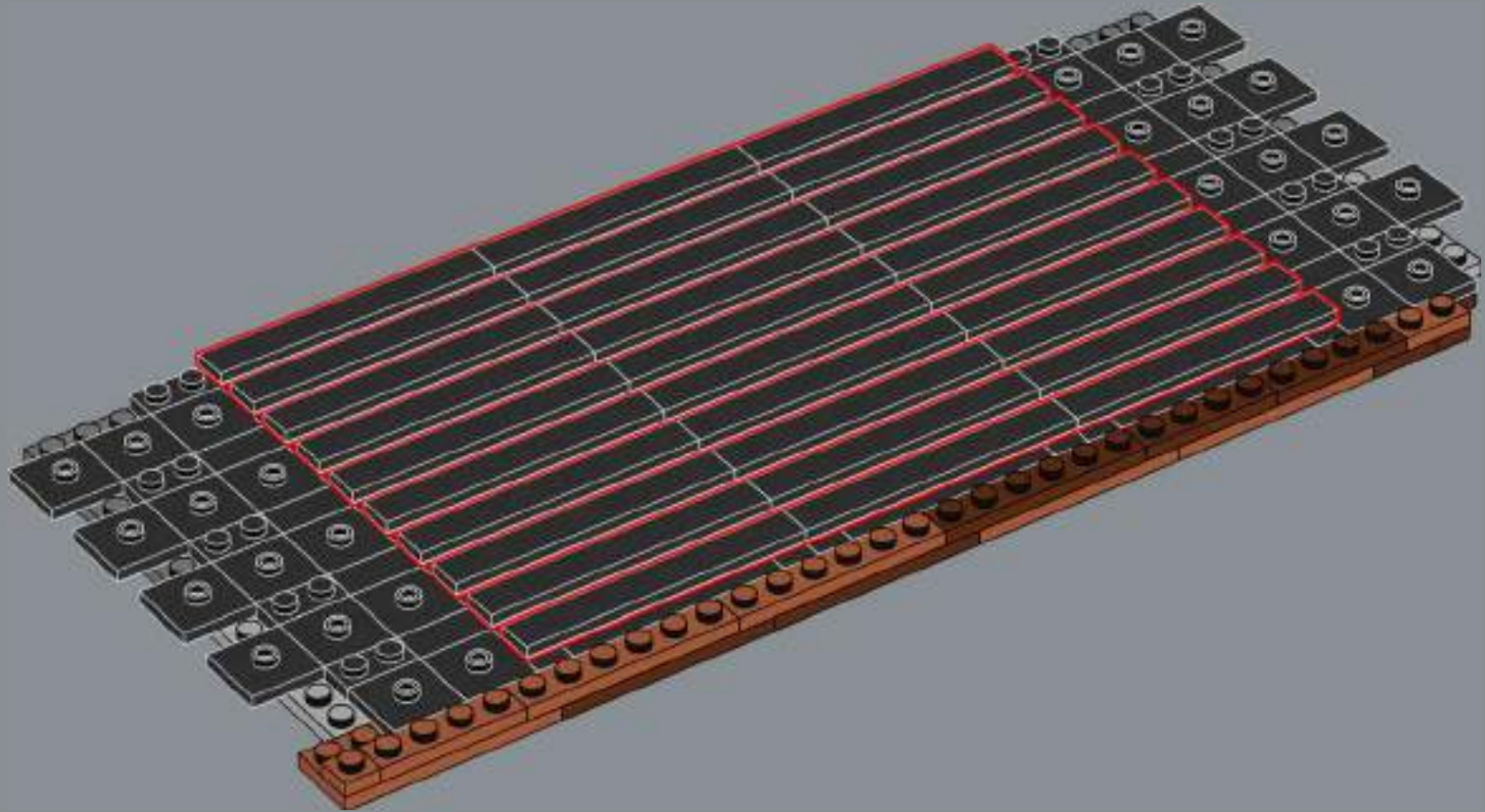



175

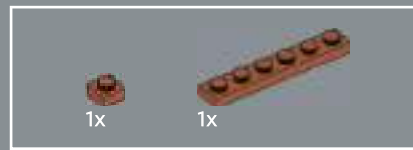

176

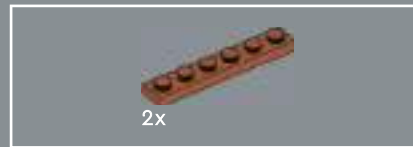
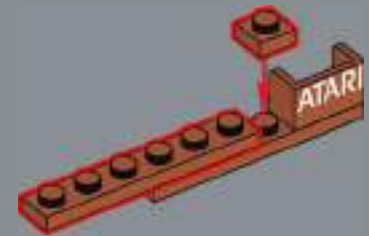

177

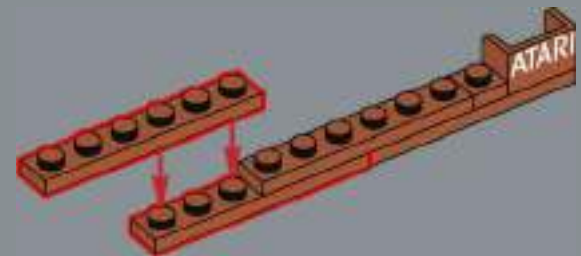

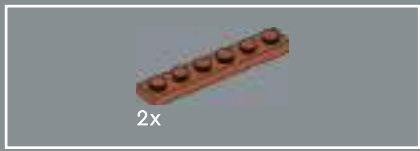

178

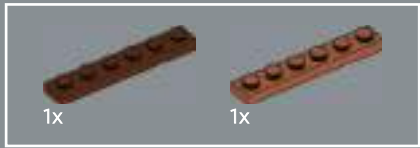
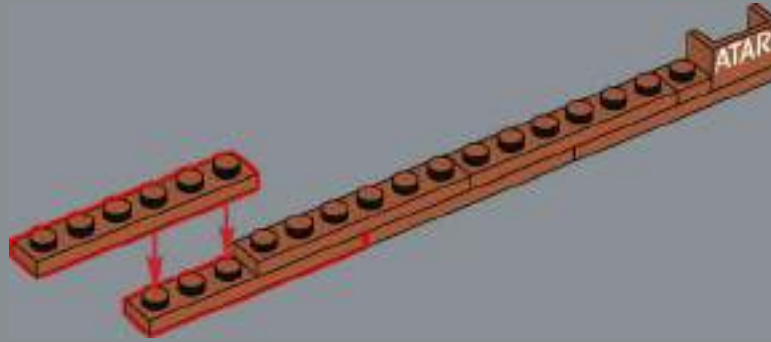

179

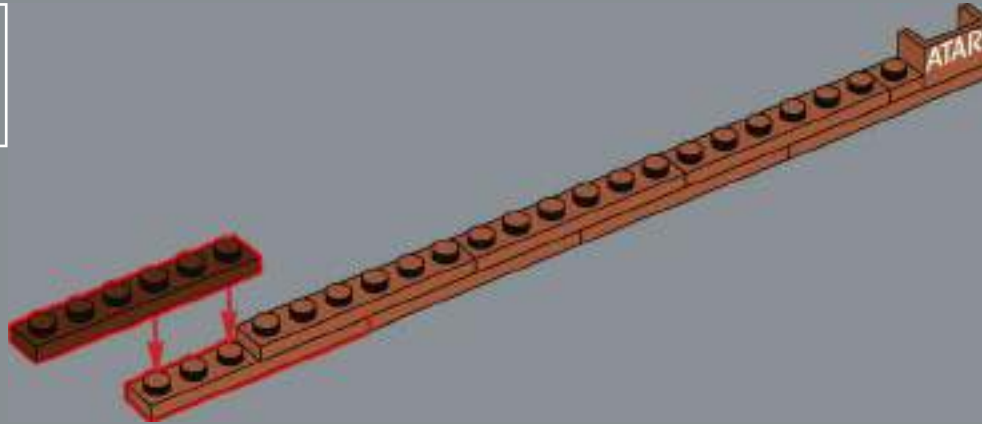

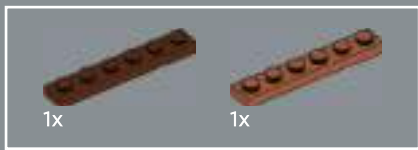

180

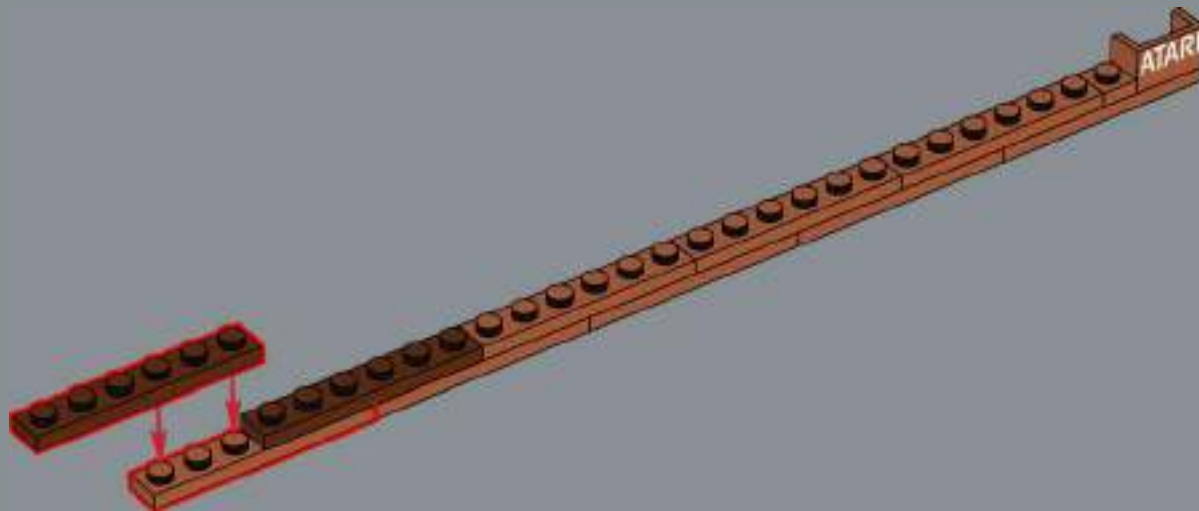

181



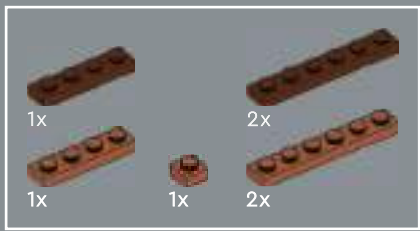

182

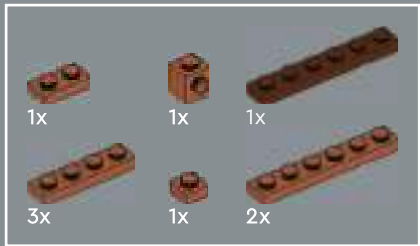
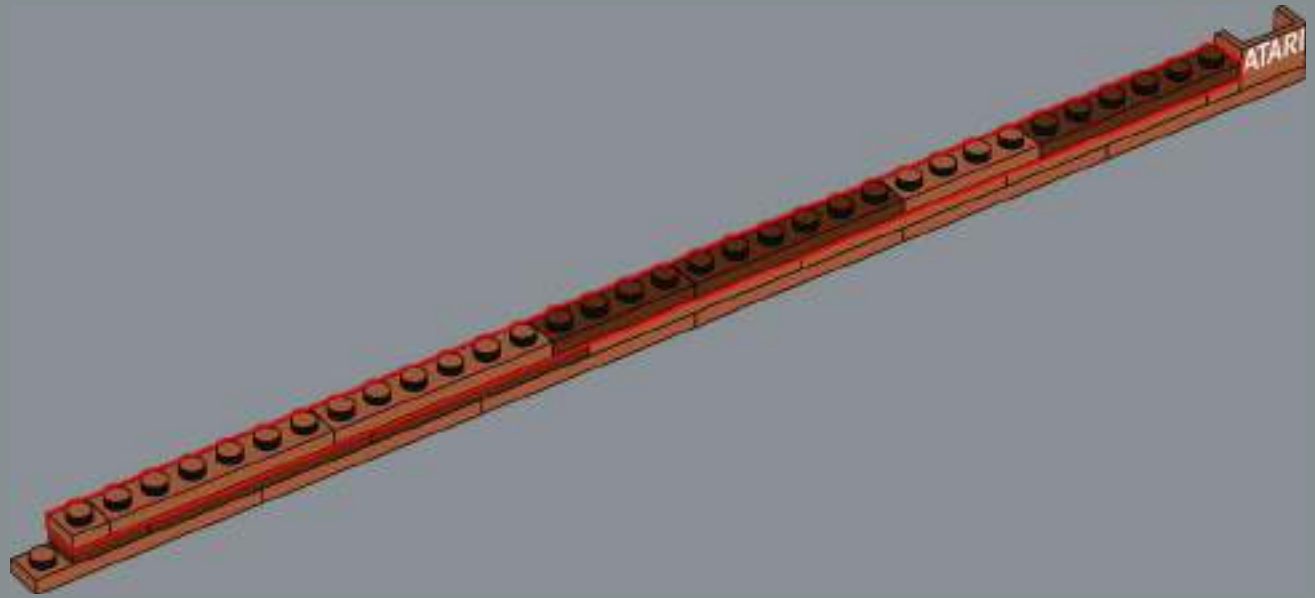

183

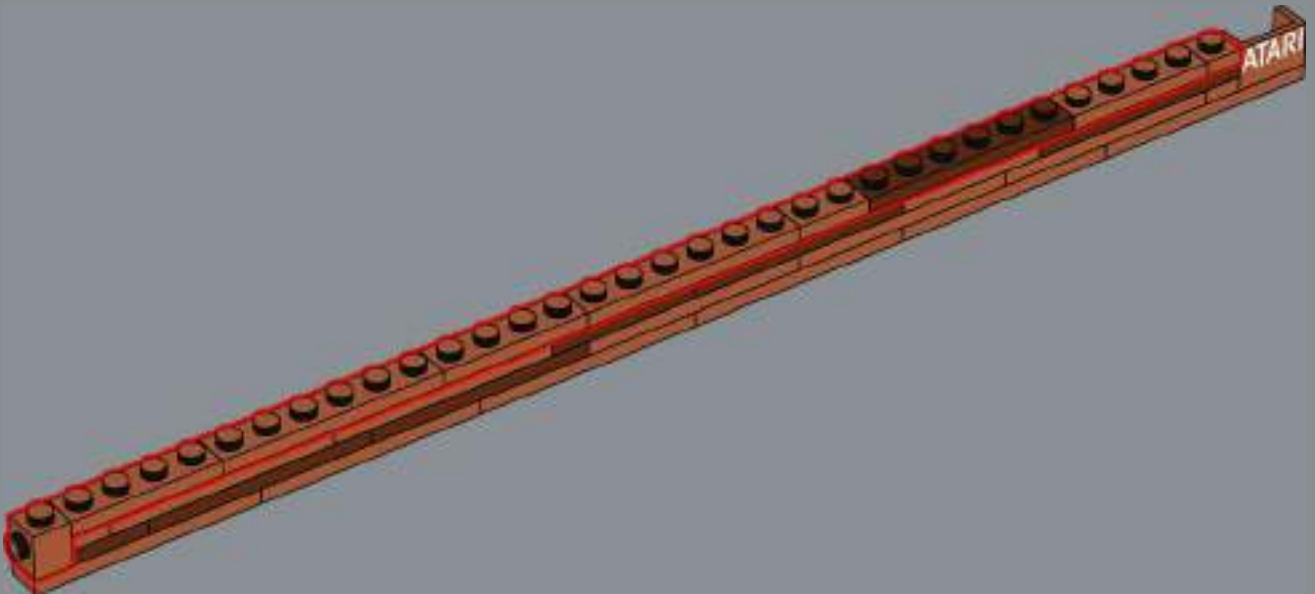

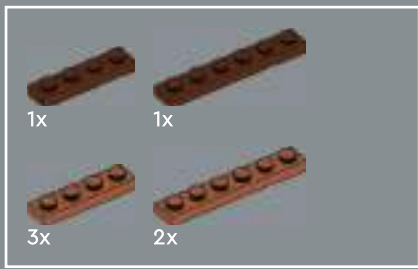

184

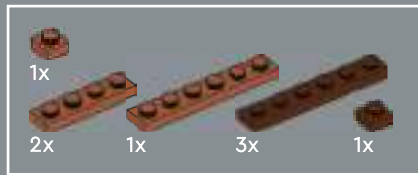
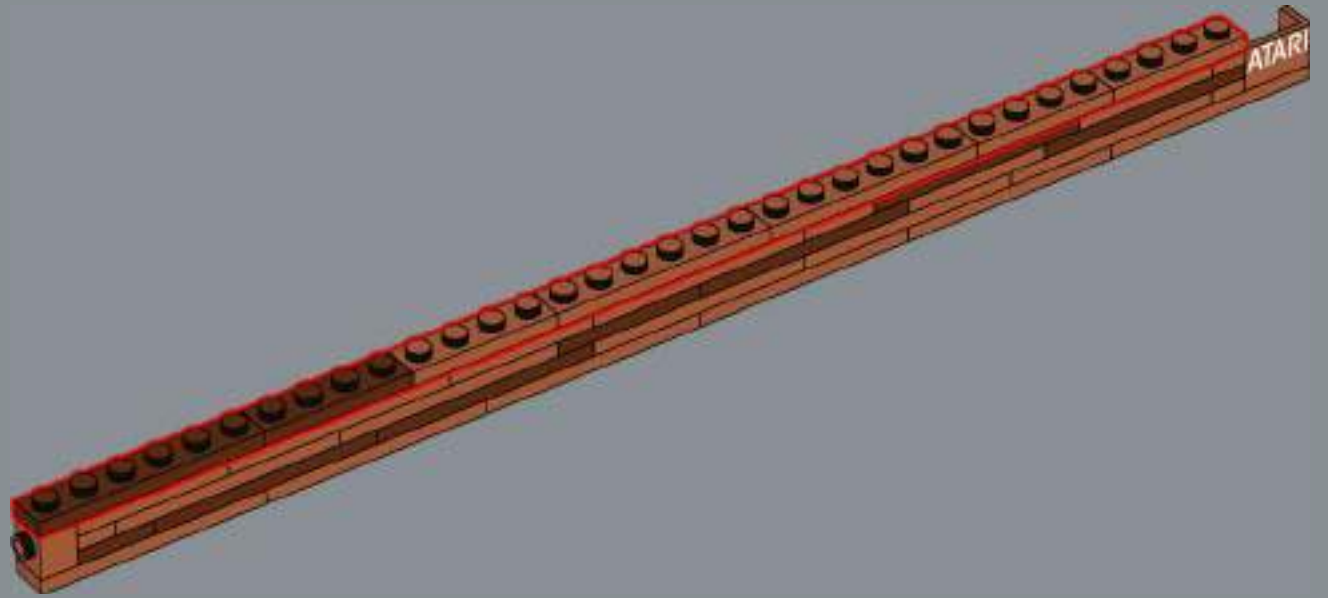

185

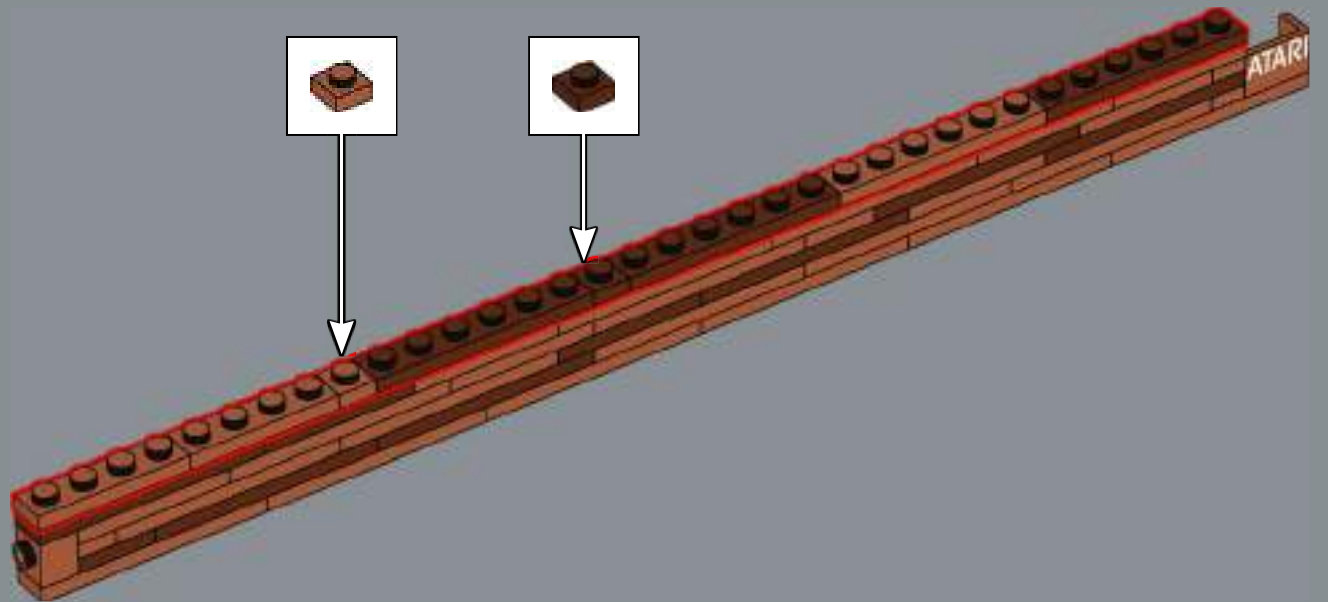

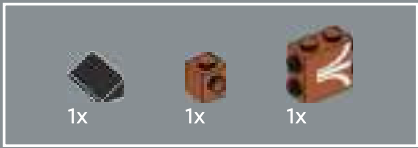

186

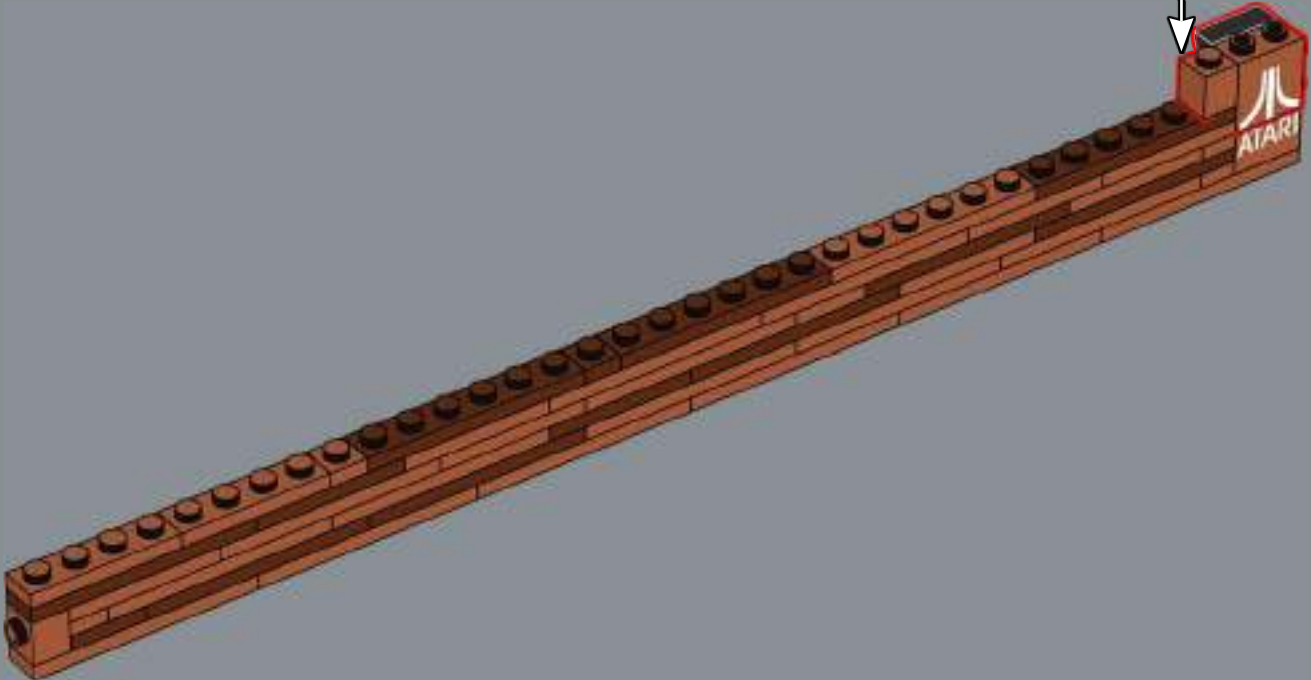
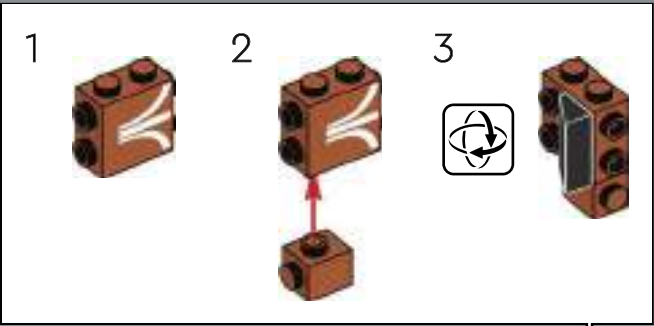

ATARI® was incorporated as a company on 27 June 1972.



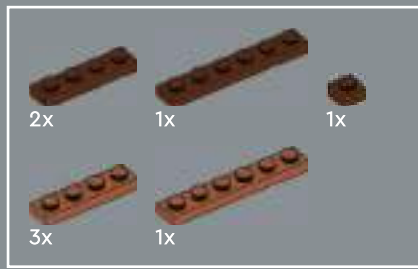

187

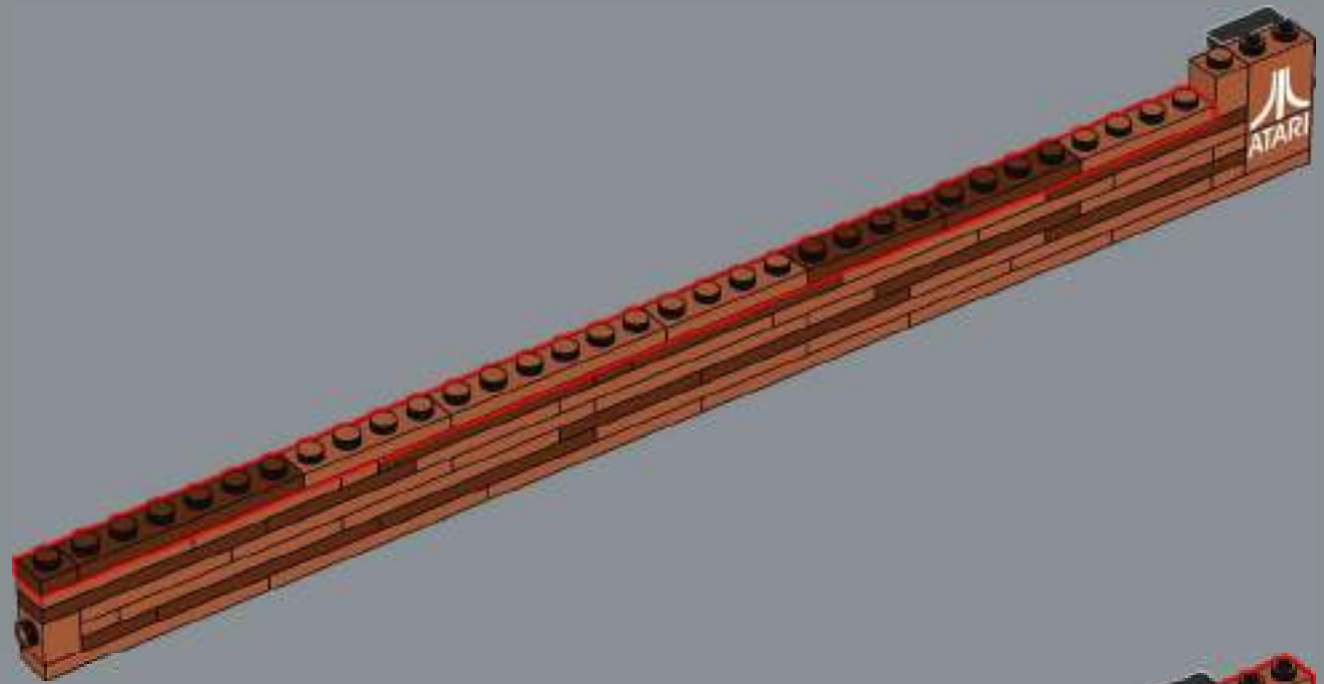

188

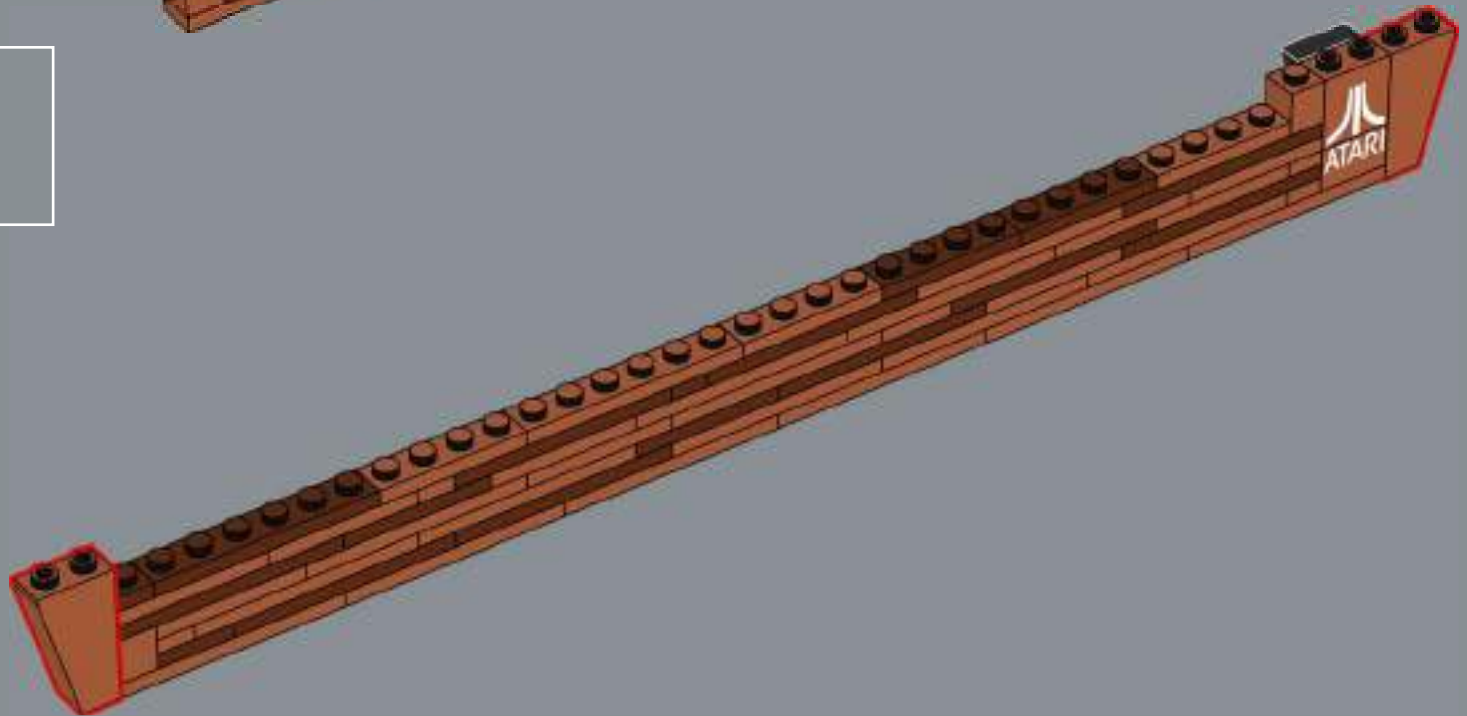

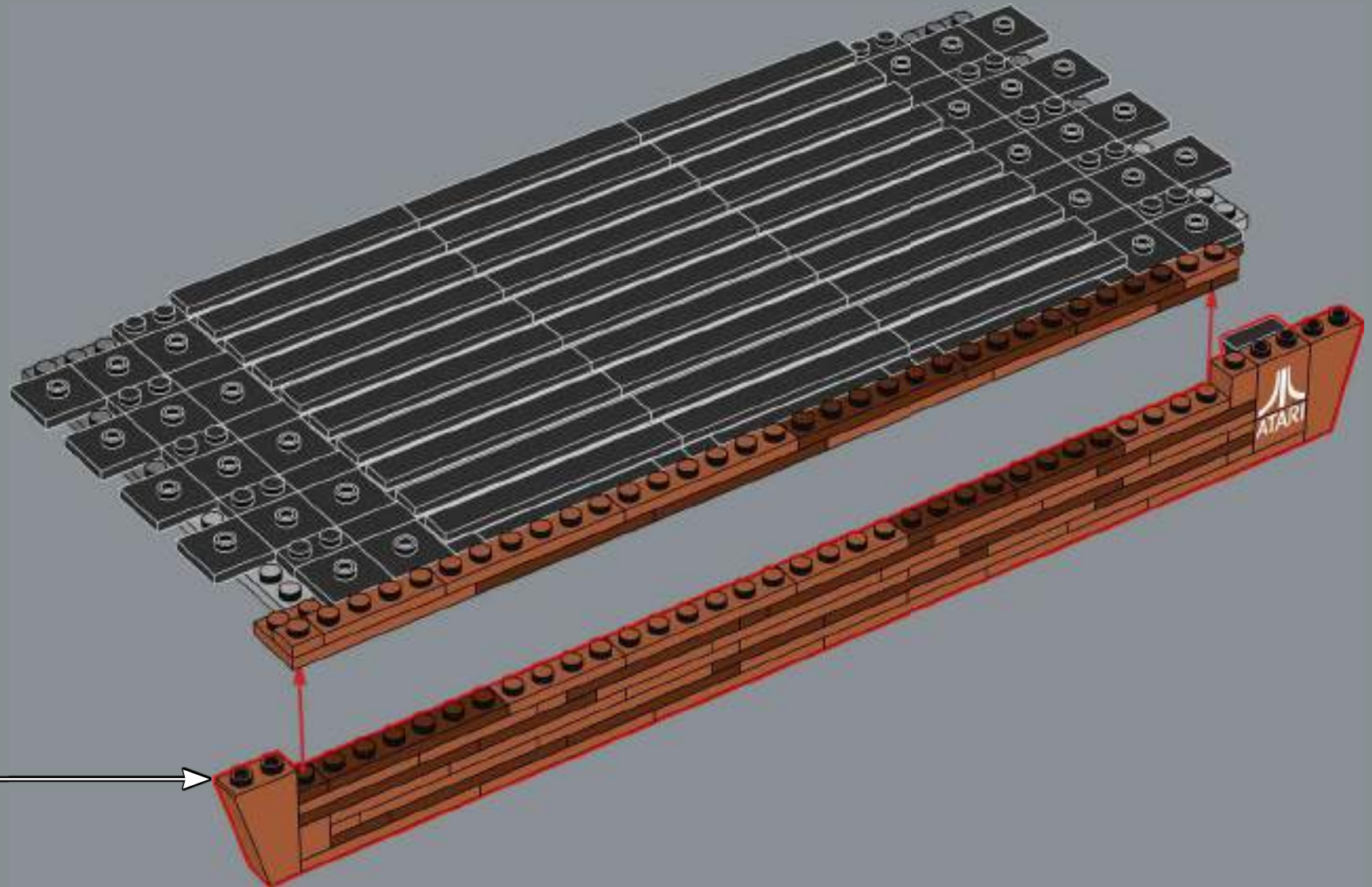



190

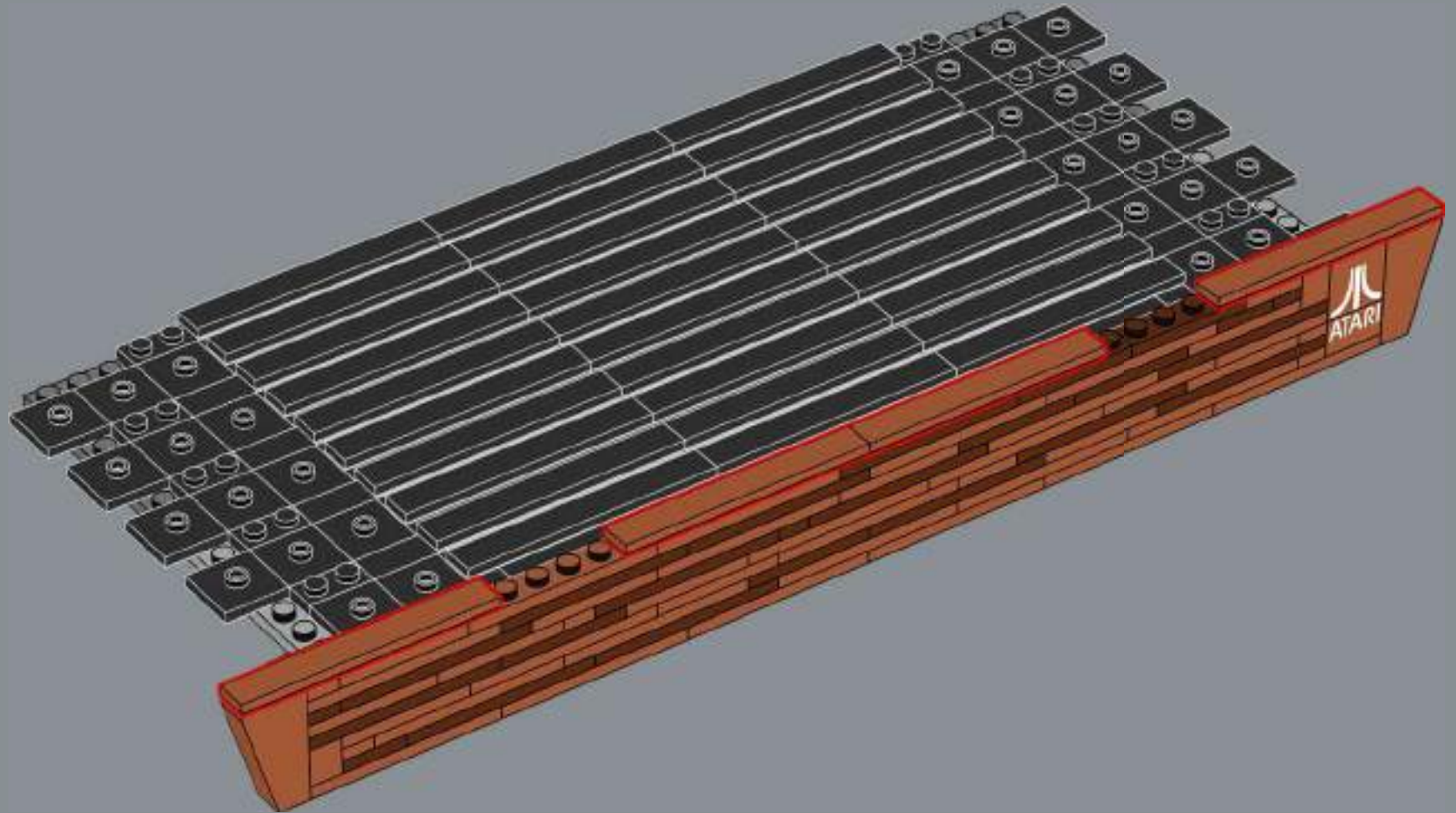



191

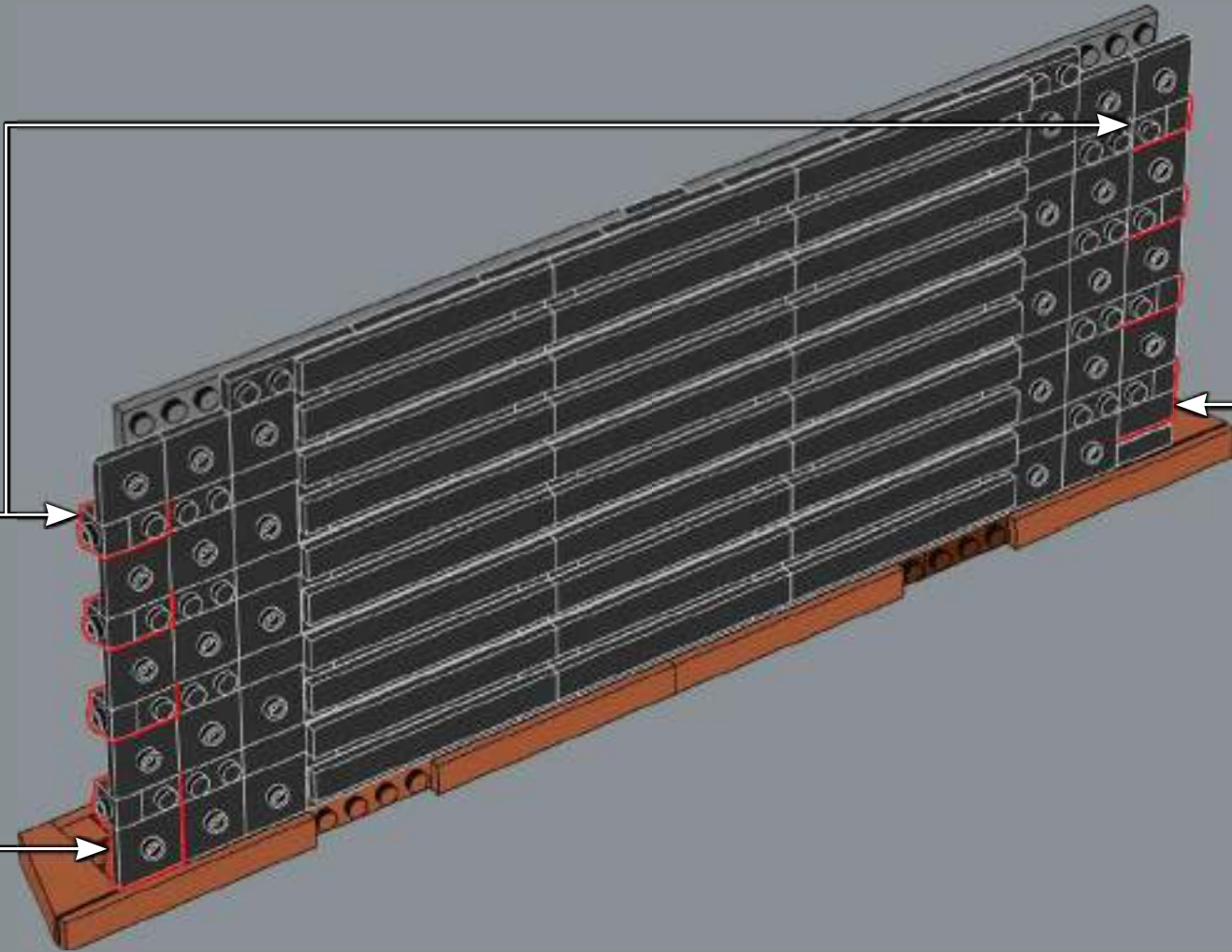
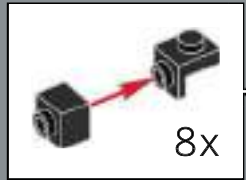



192

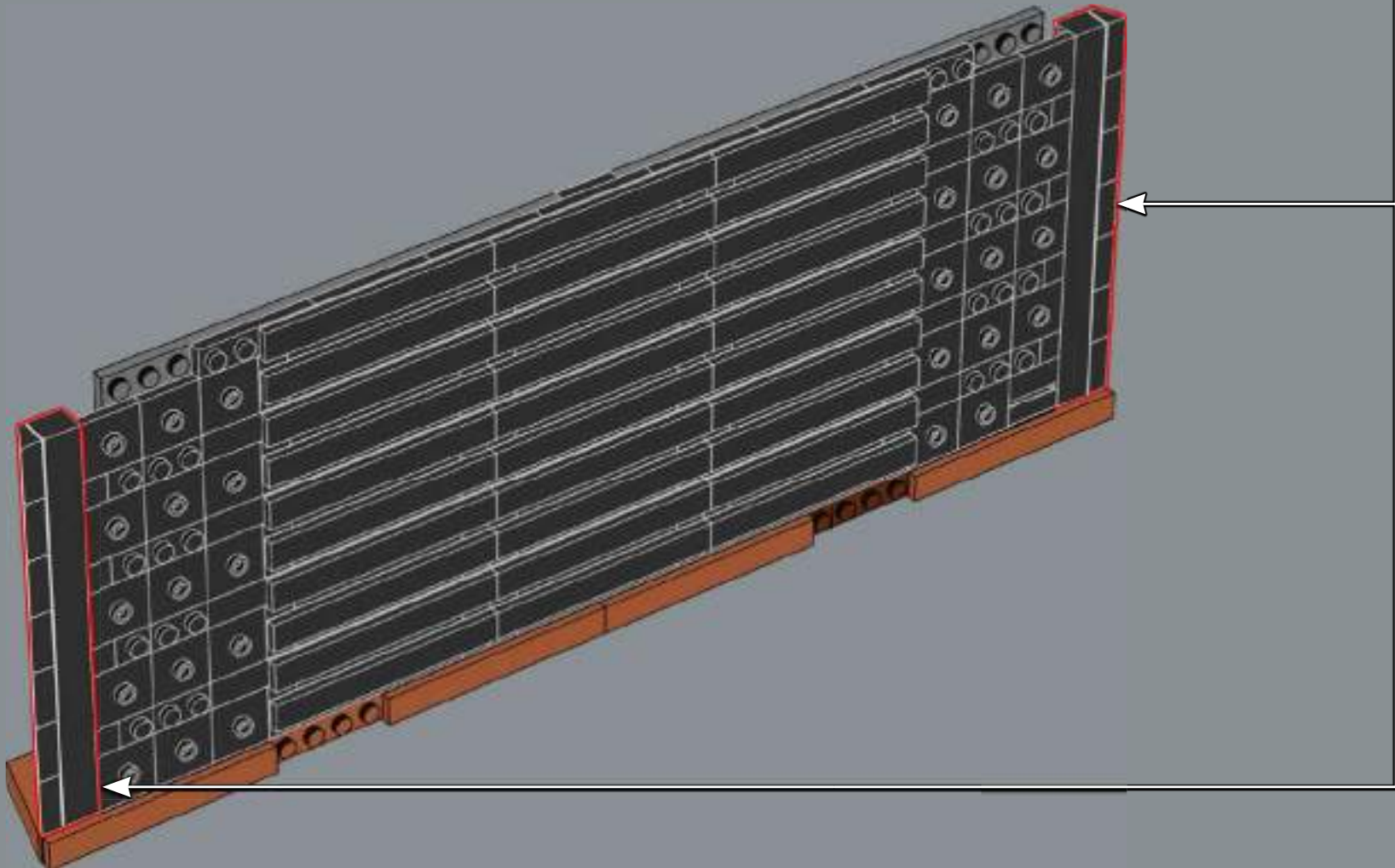
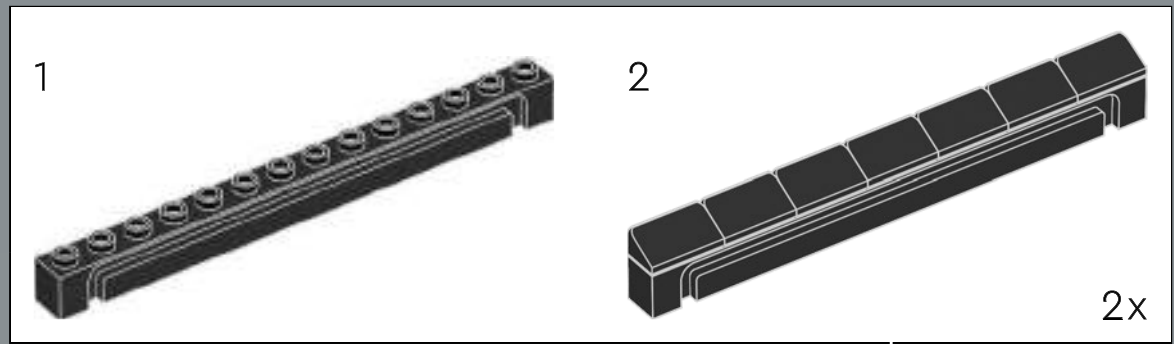



193

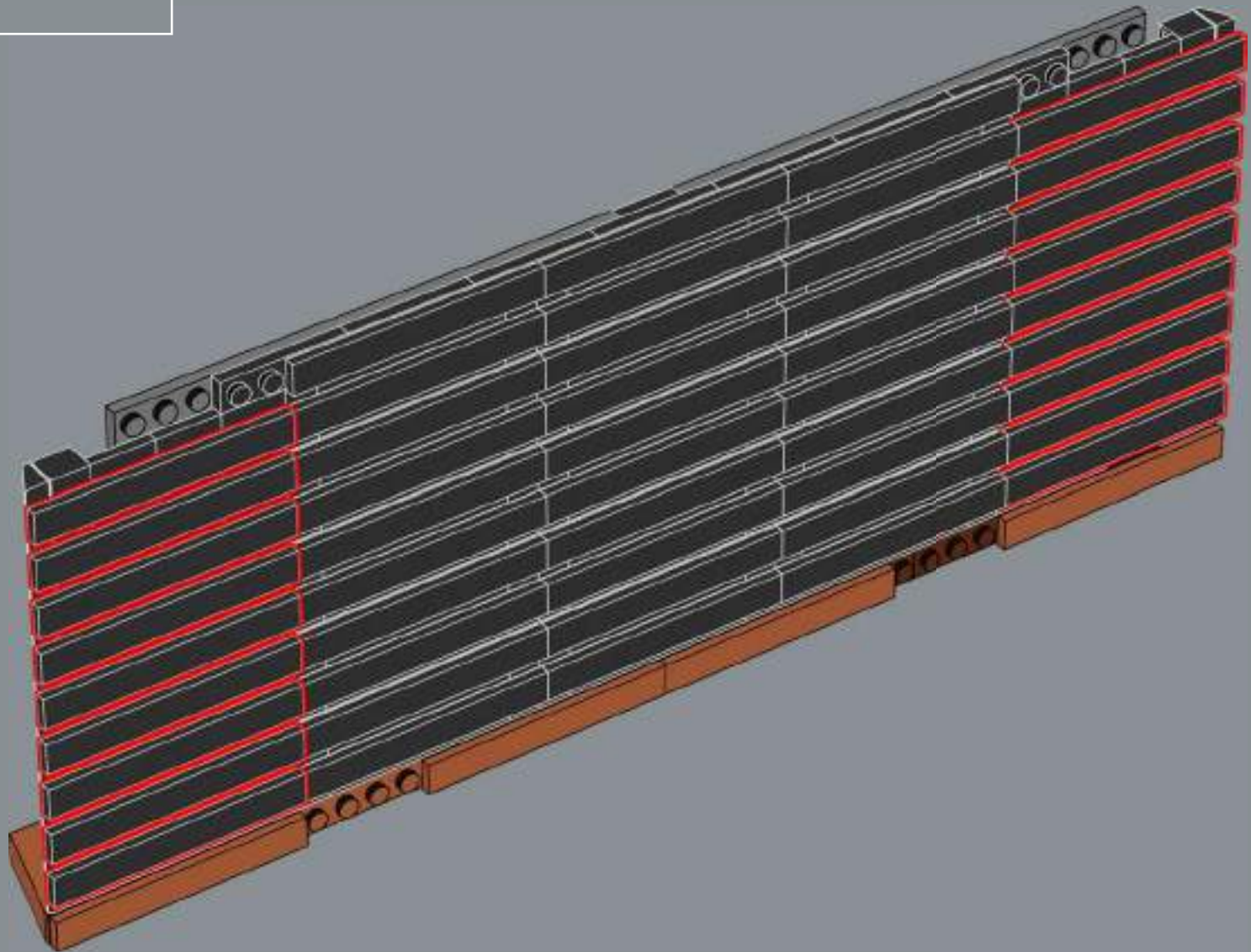



194

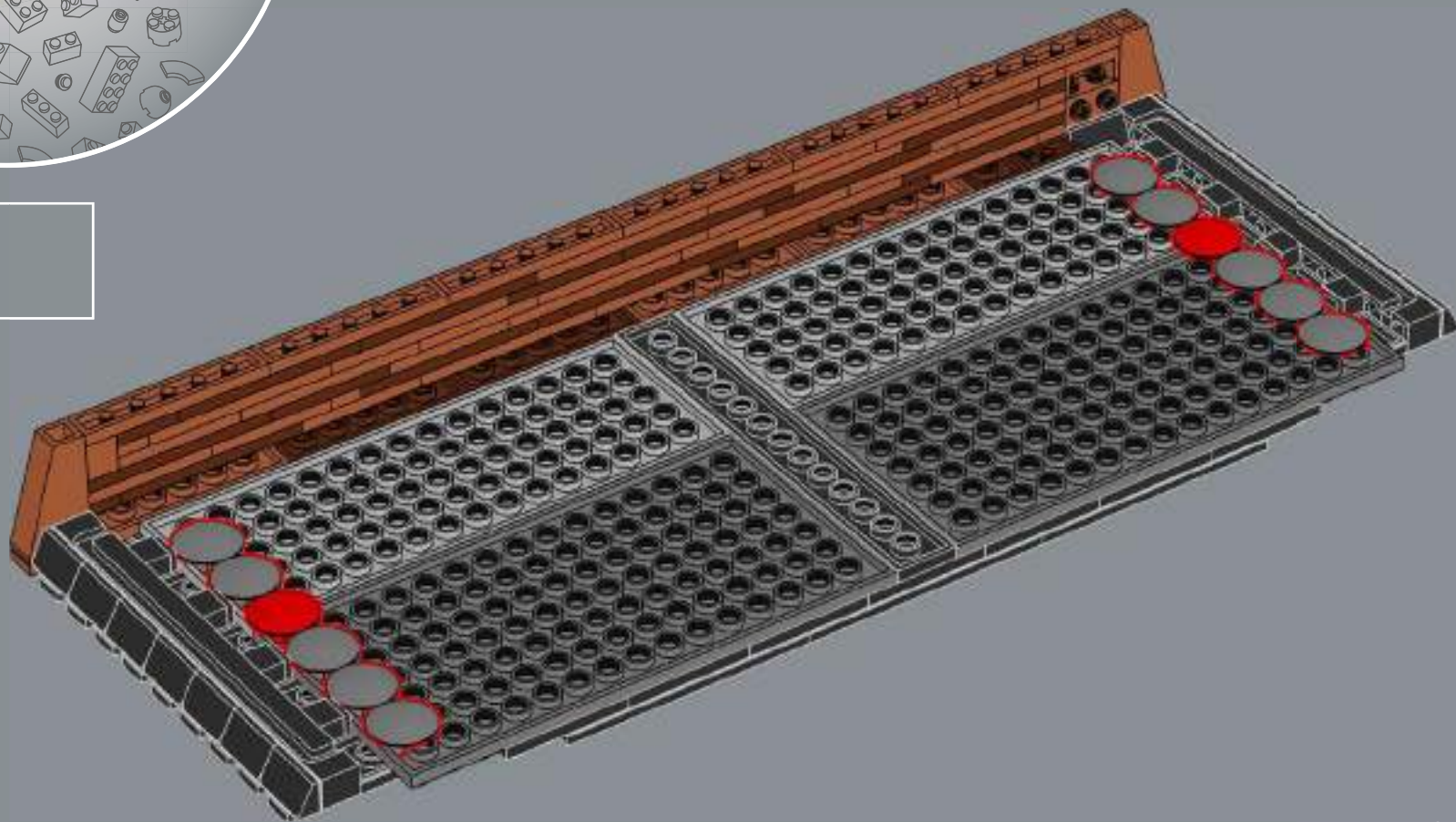

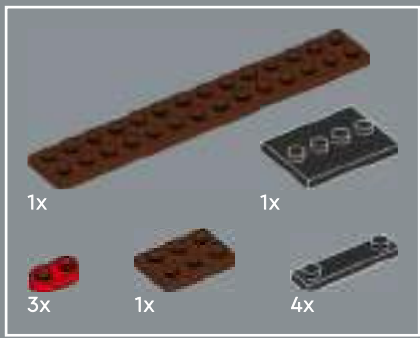

195

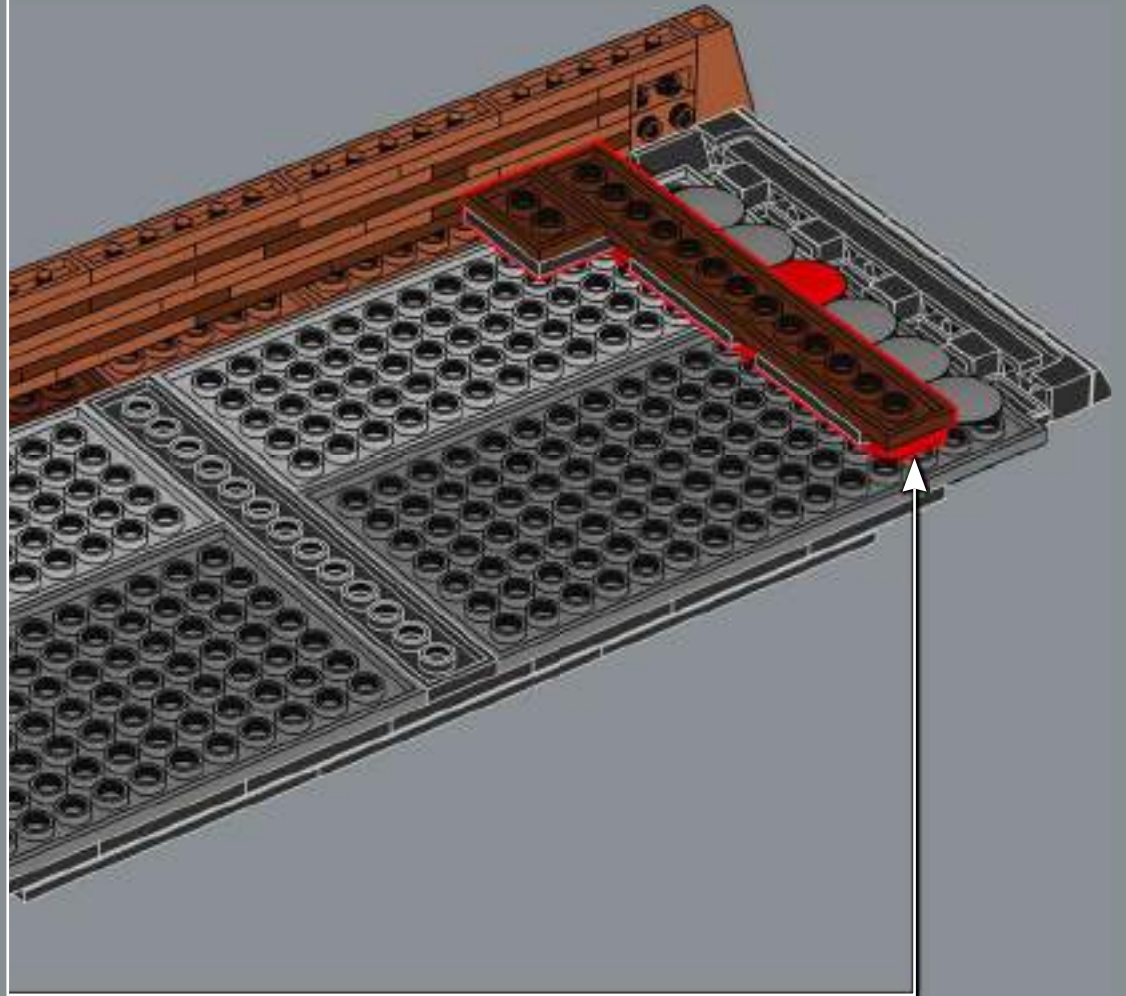
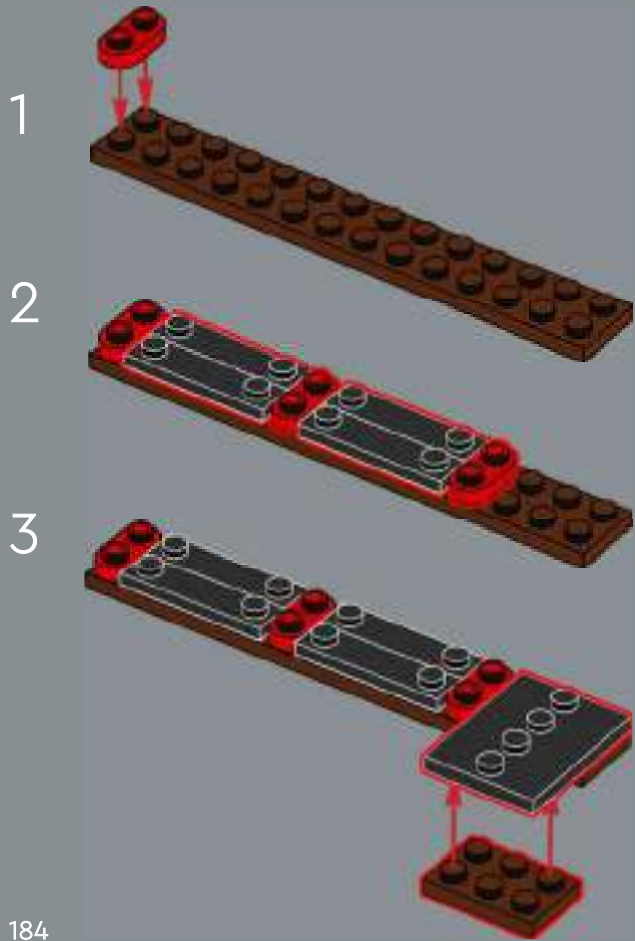

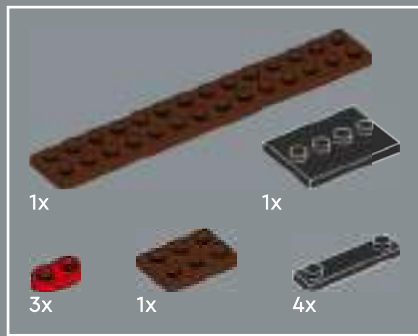

196

1



2



3

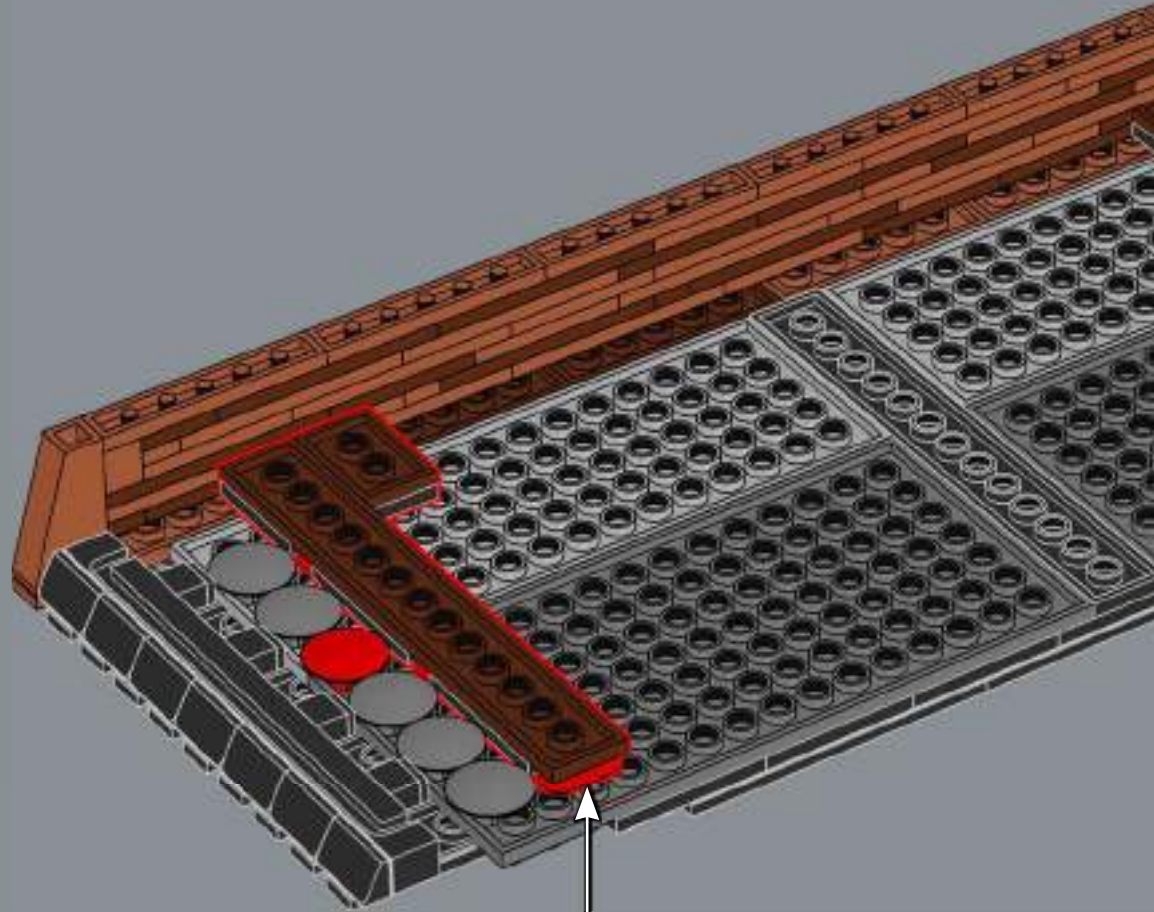
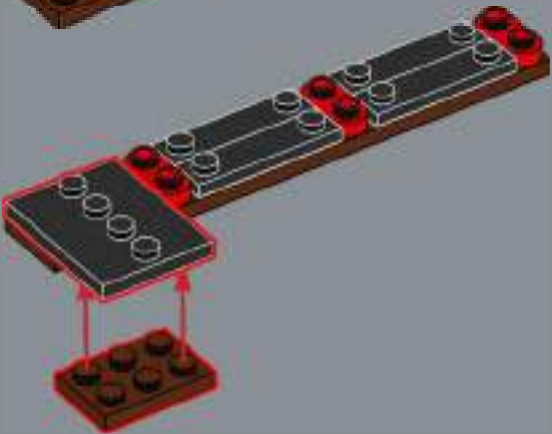

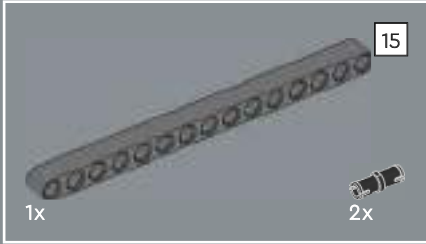

197

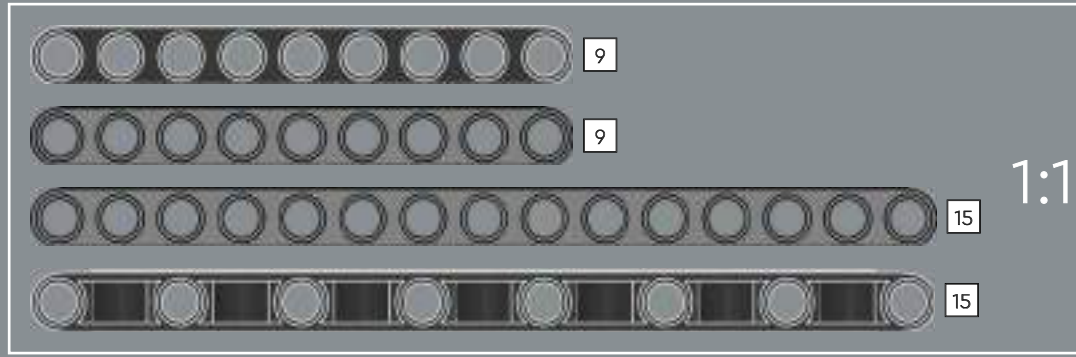

198

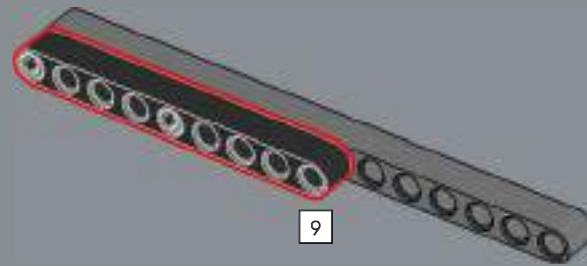

199

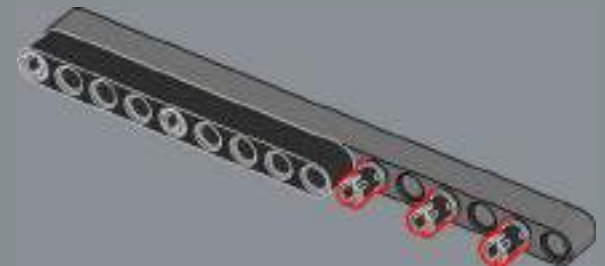



200

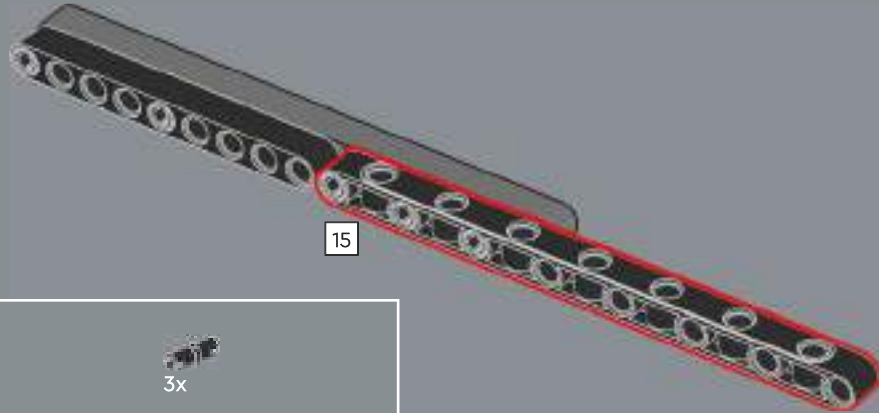

201

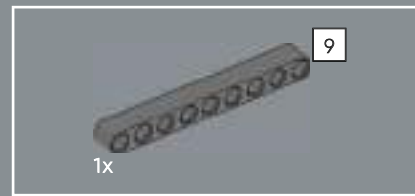
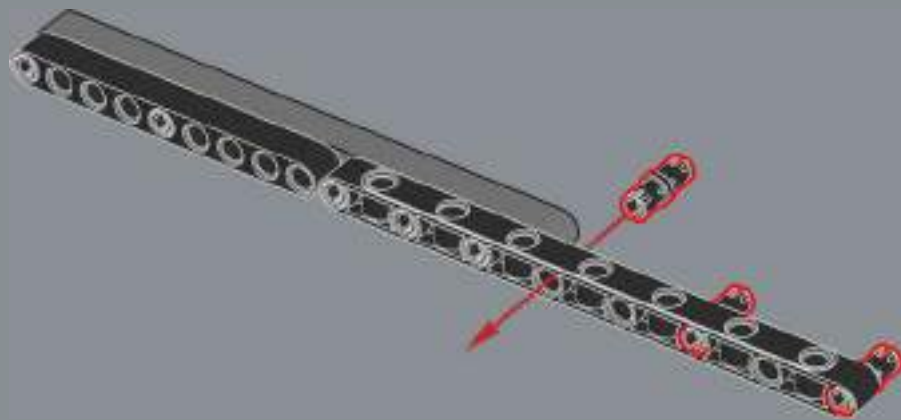

202

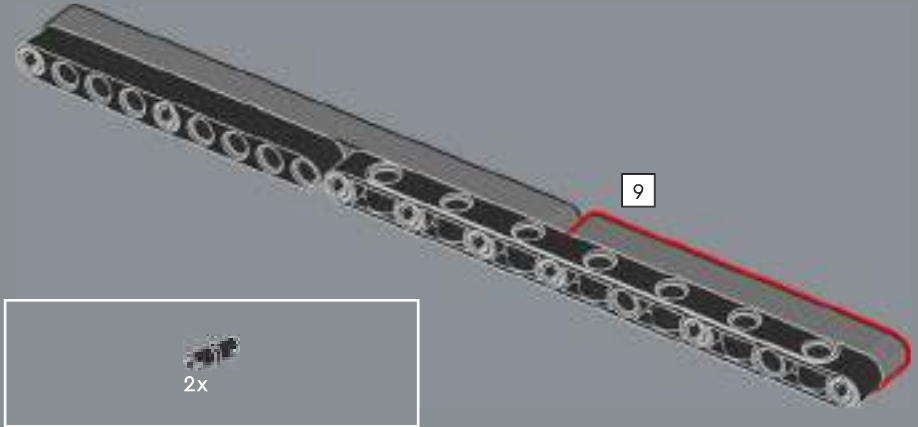

203

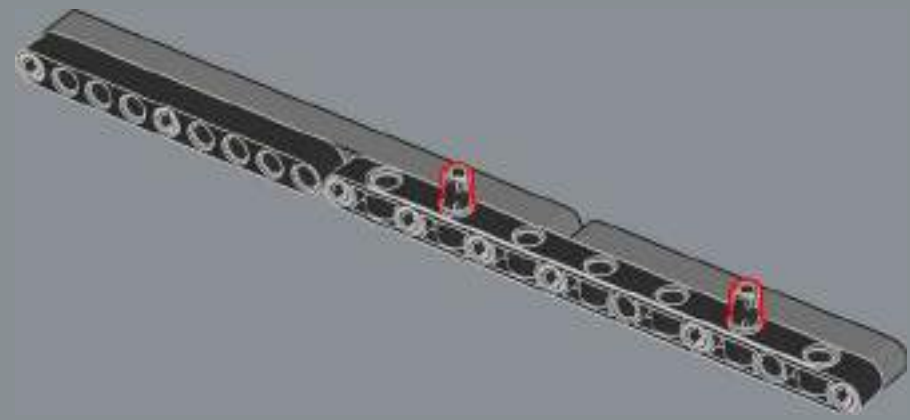



204

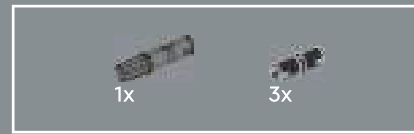

205

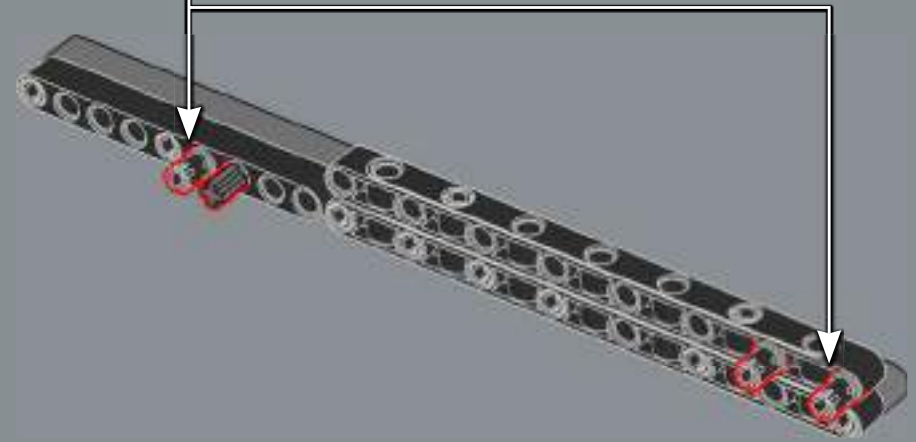
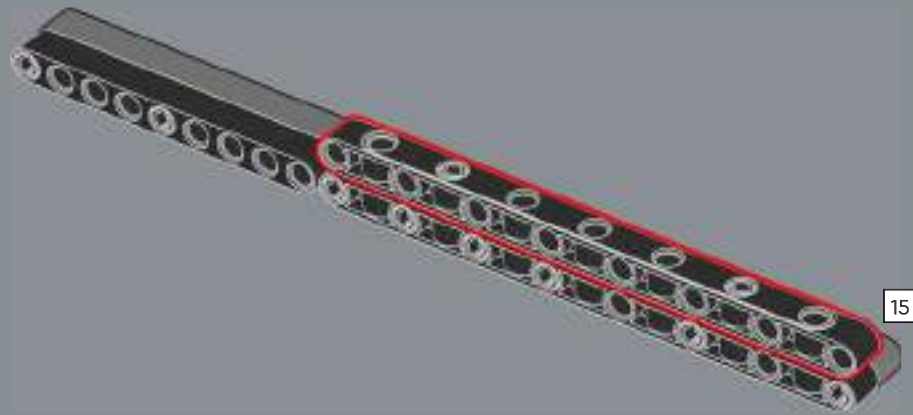



206

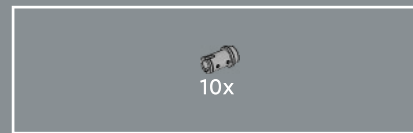
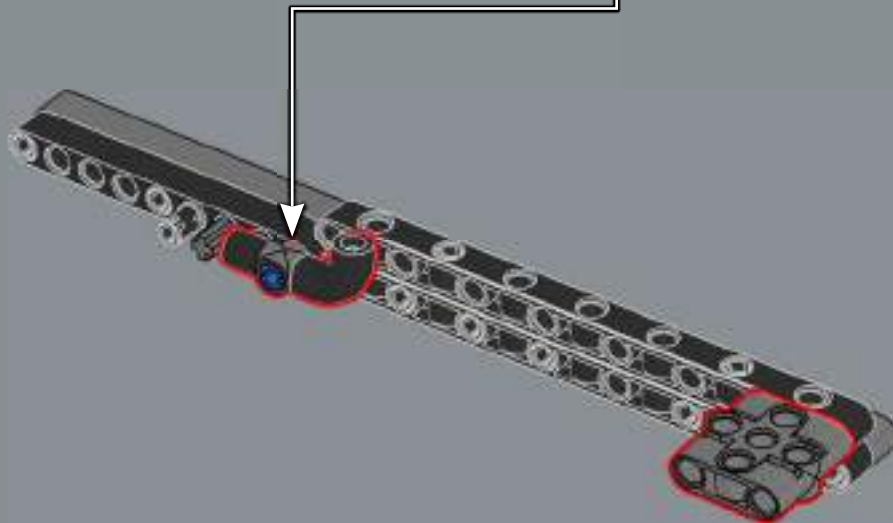

207

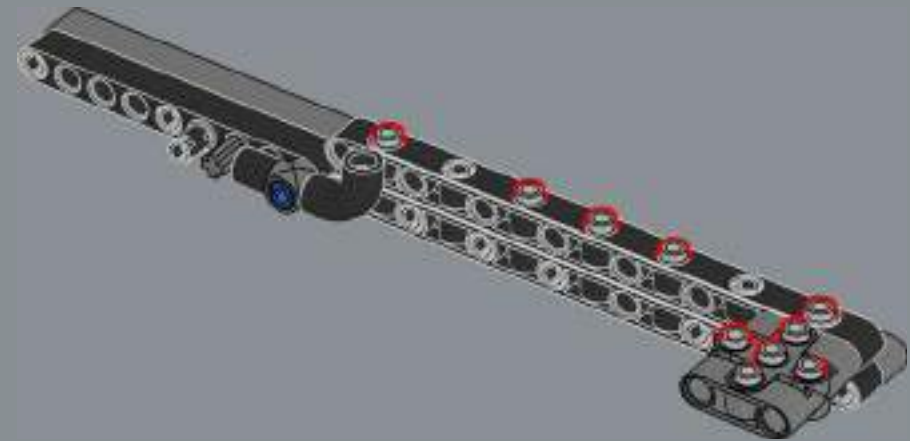

208

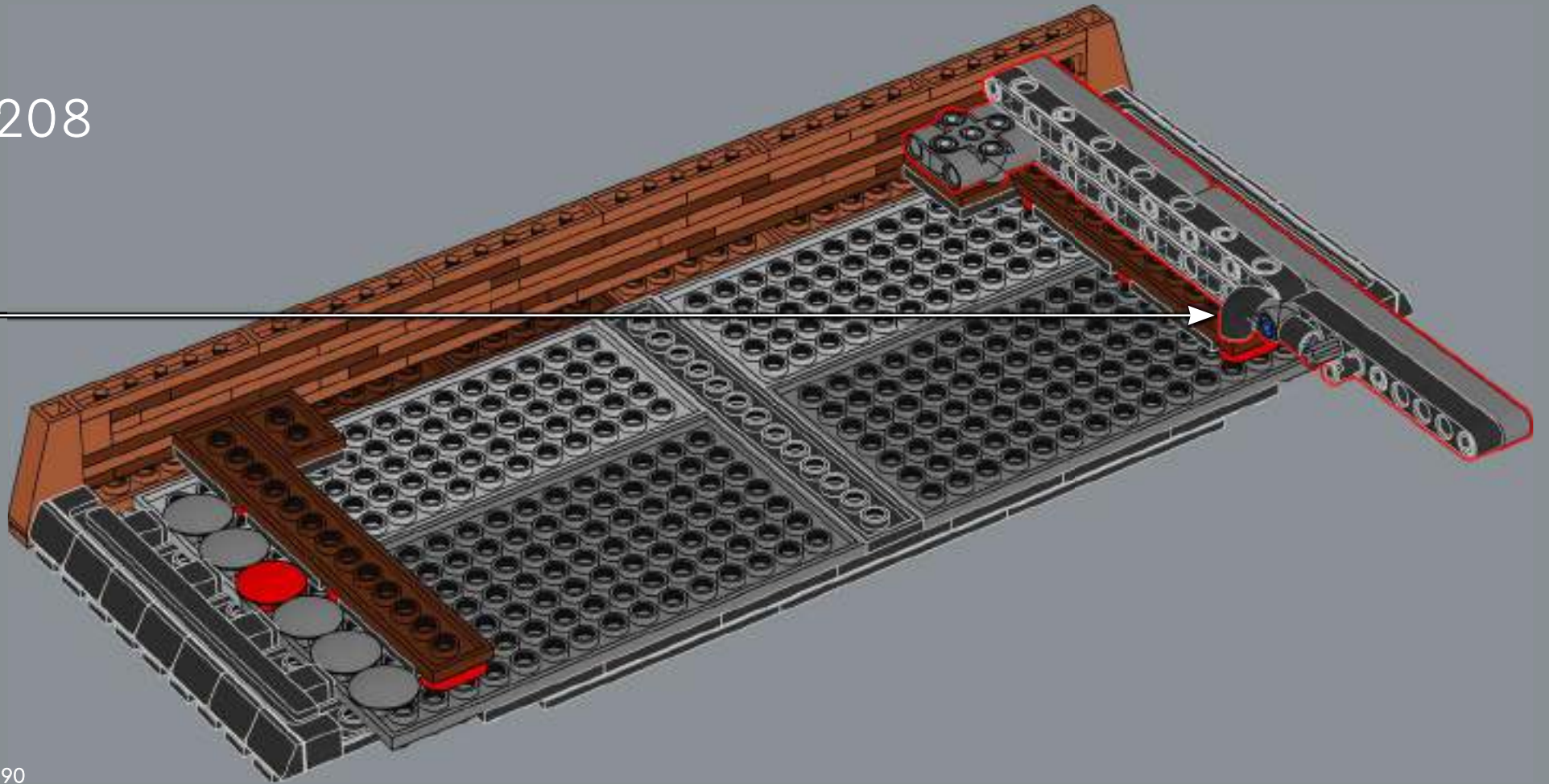

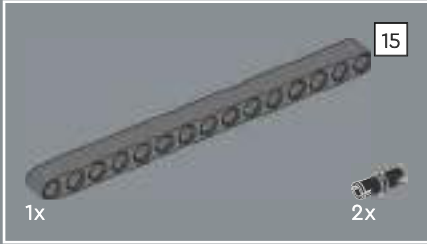
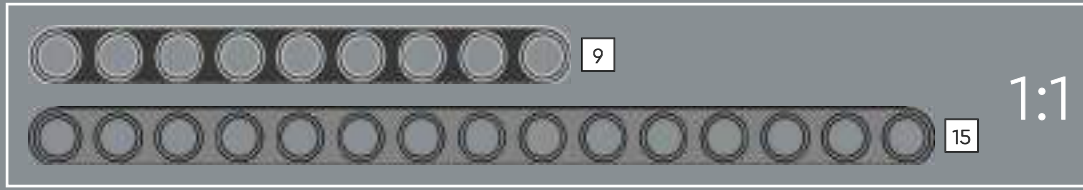

209

210

211

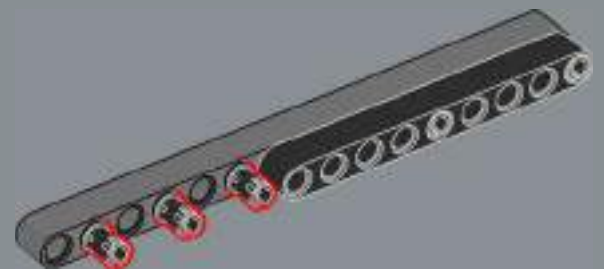
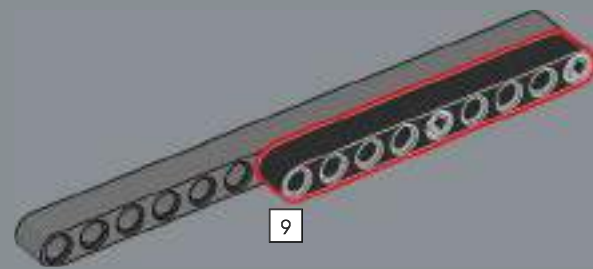
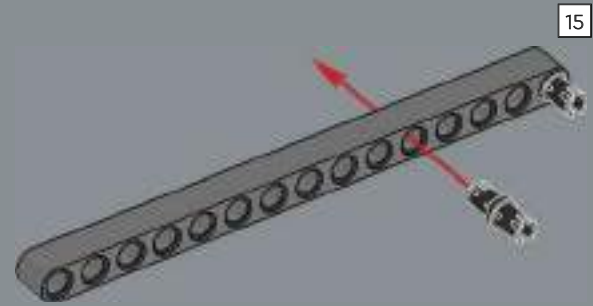



212

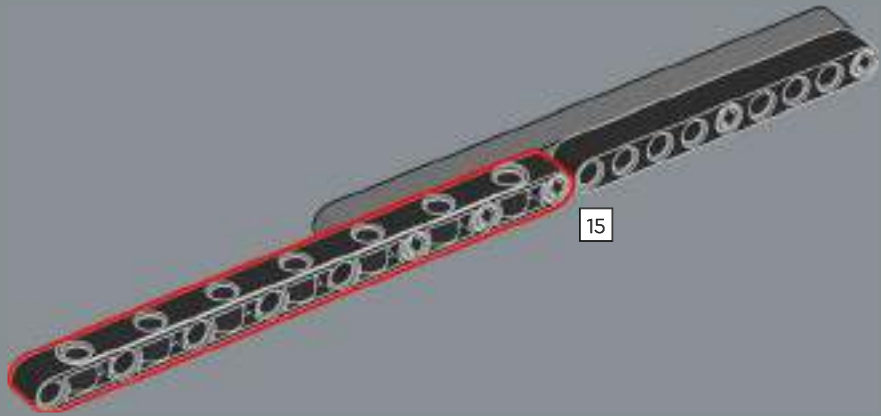

213

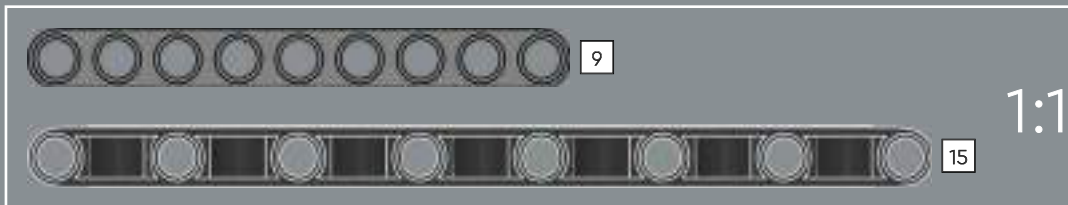
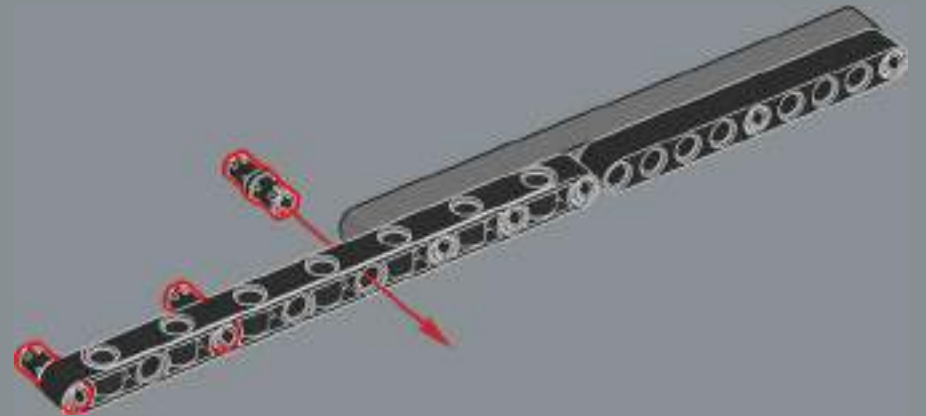

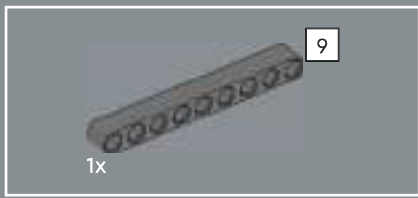

214

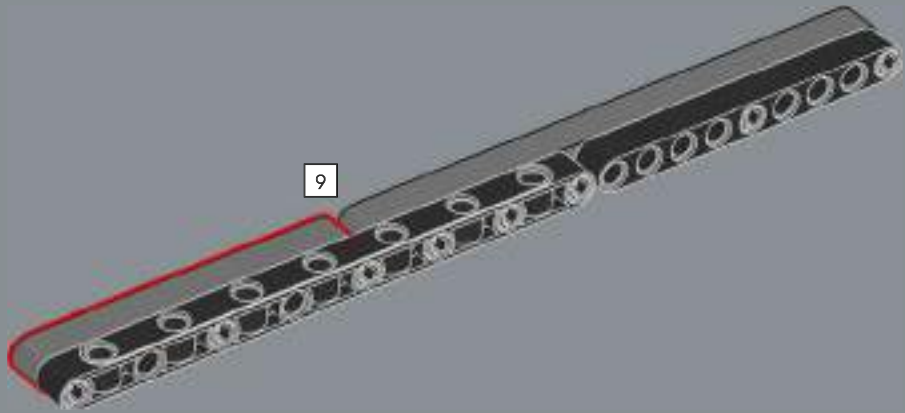

215

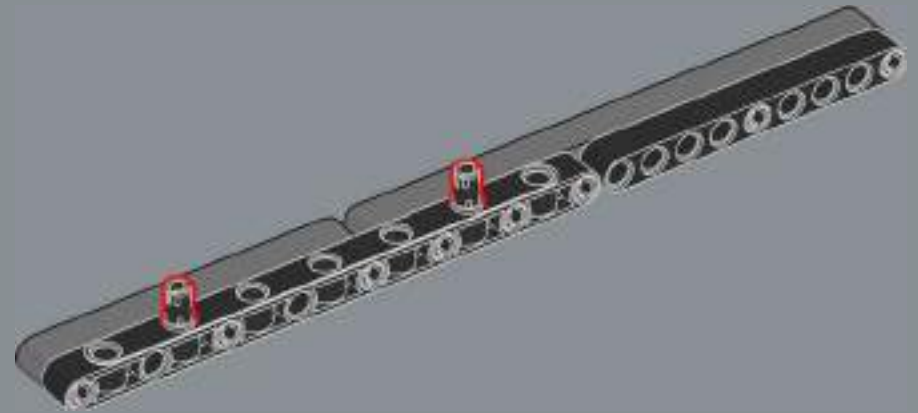



216

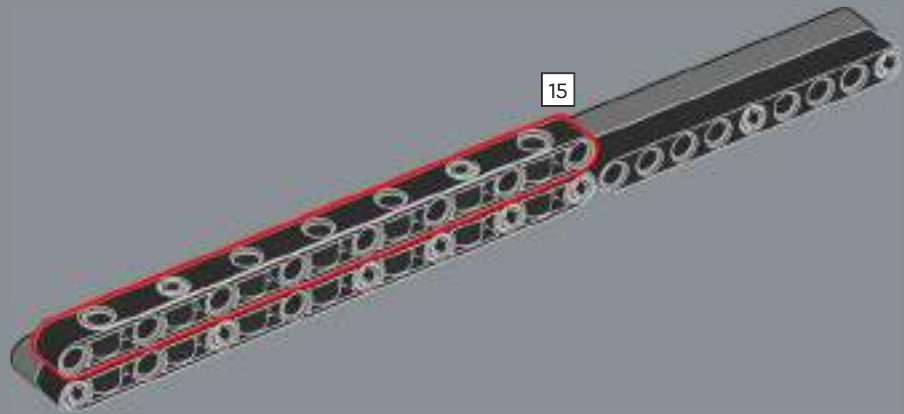

217

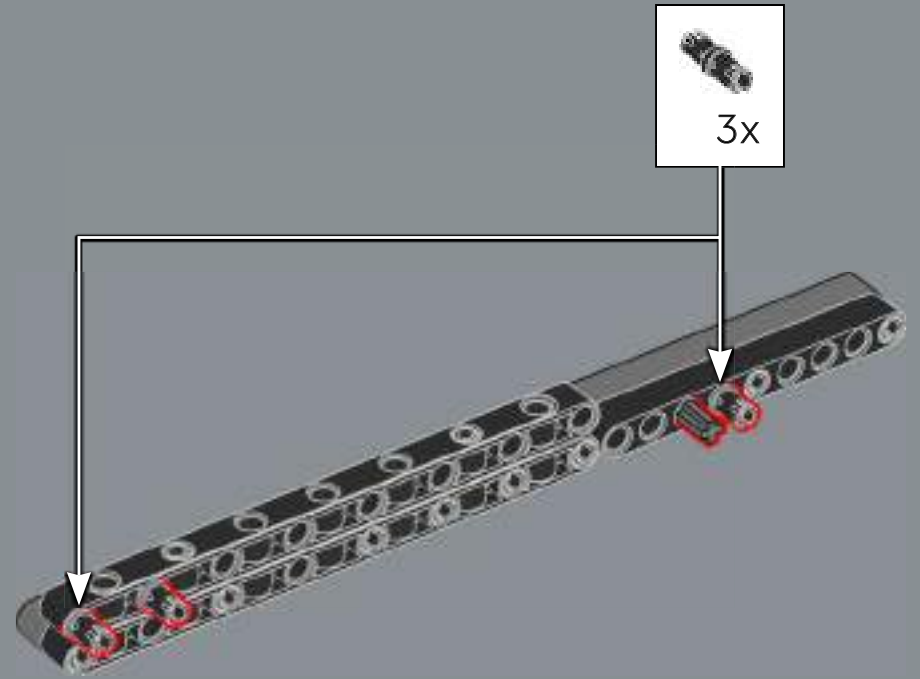



218

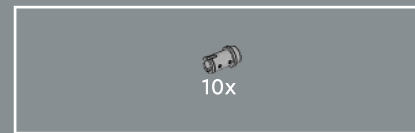
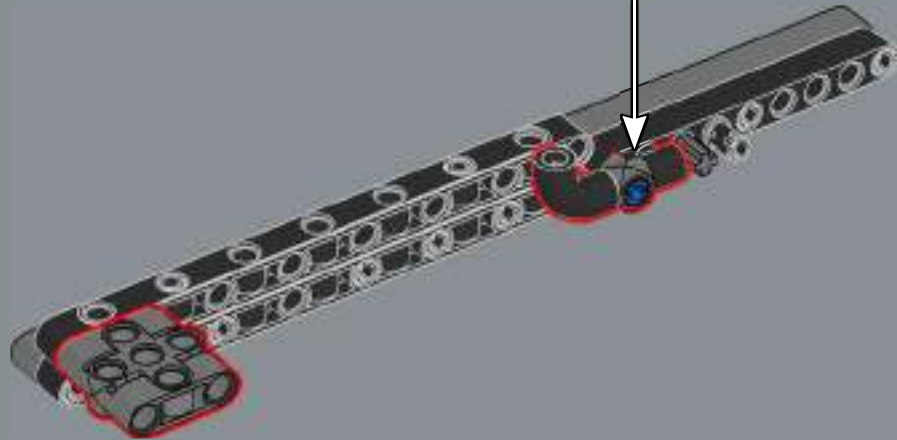

219

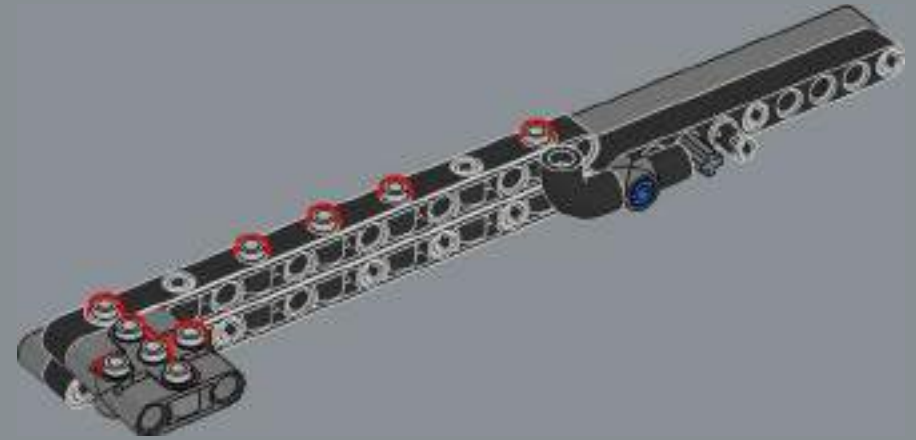

220

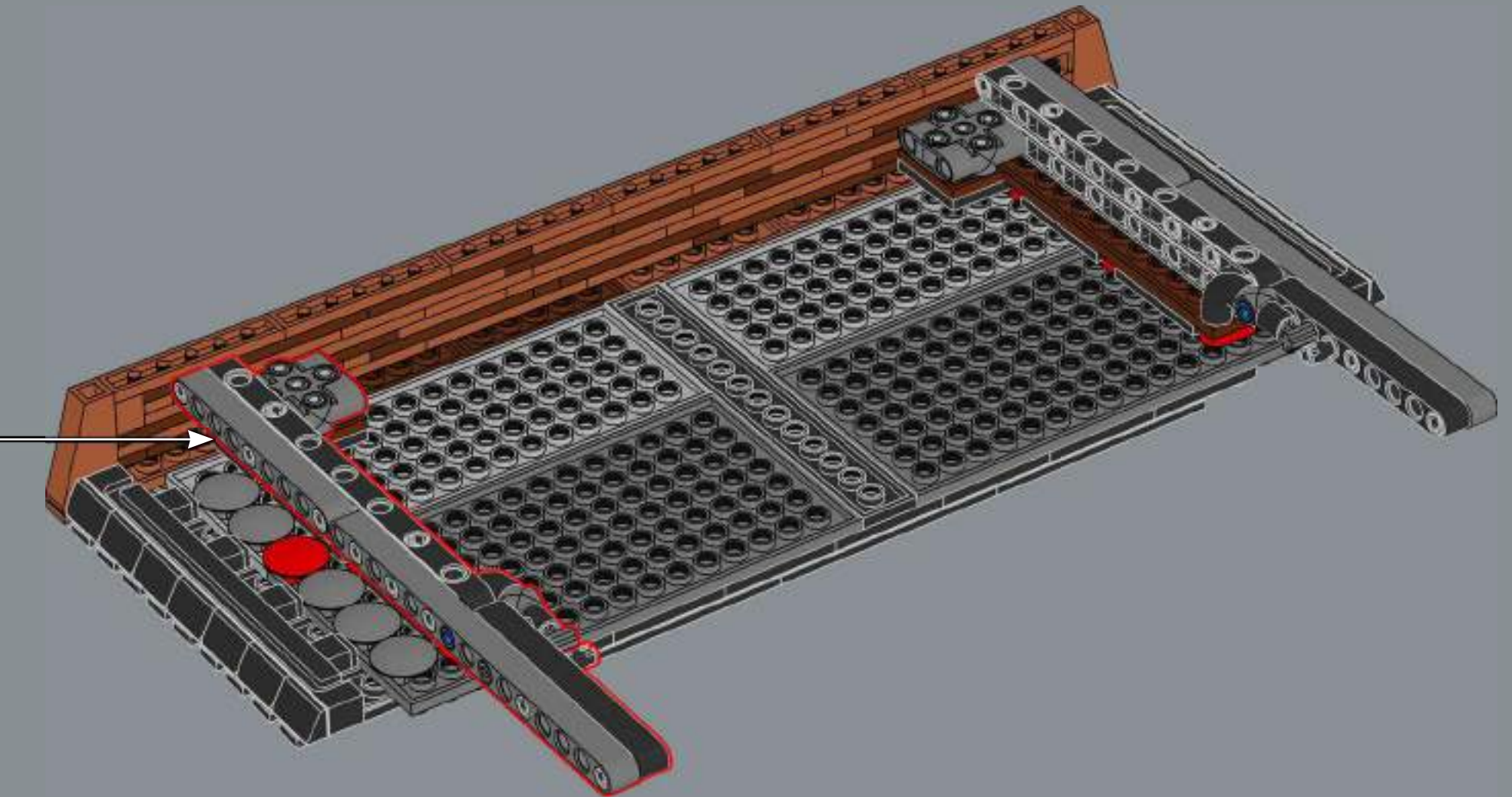



221

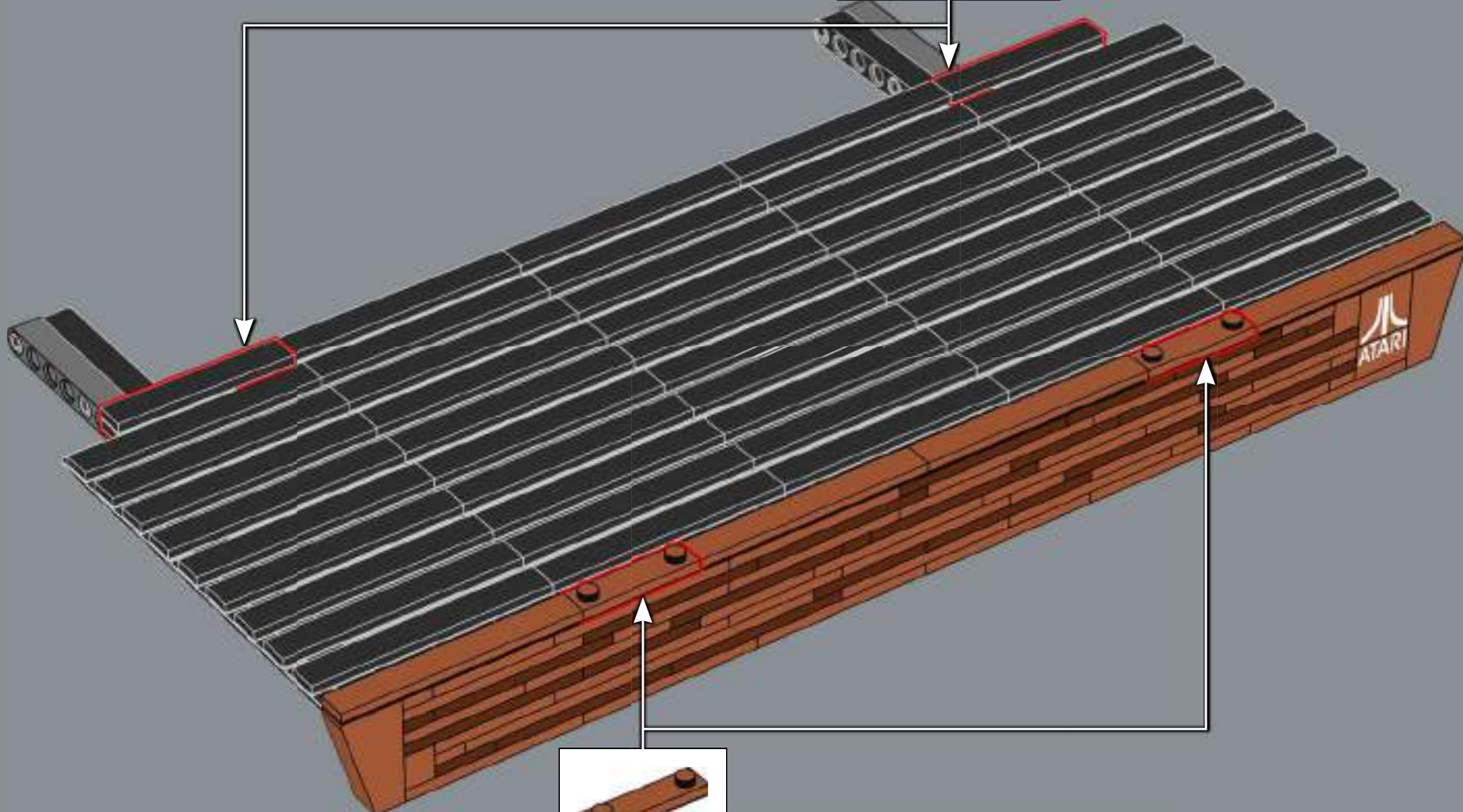
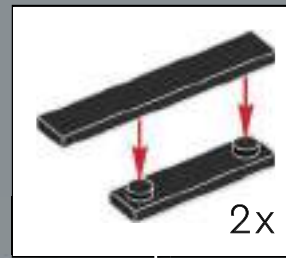

222

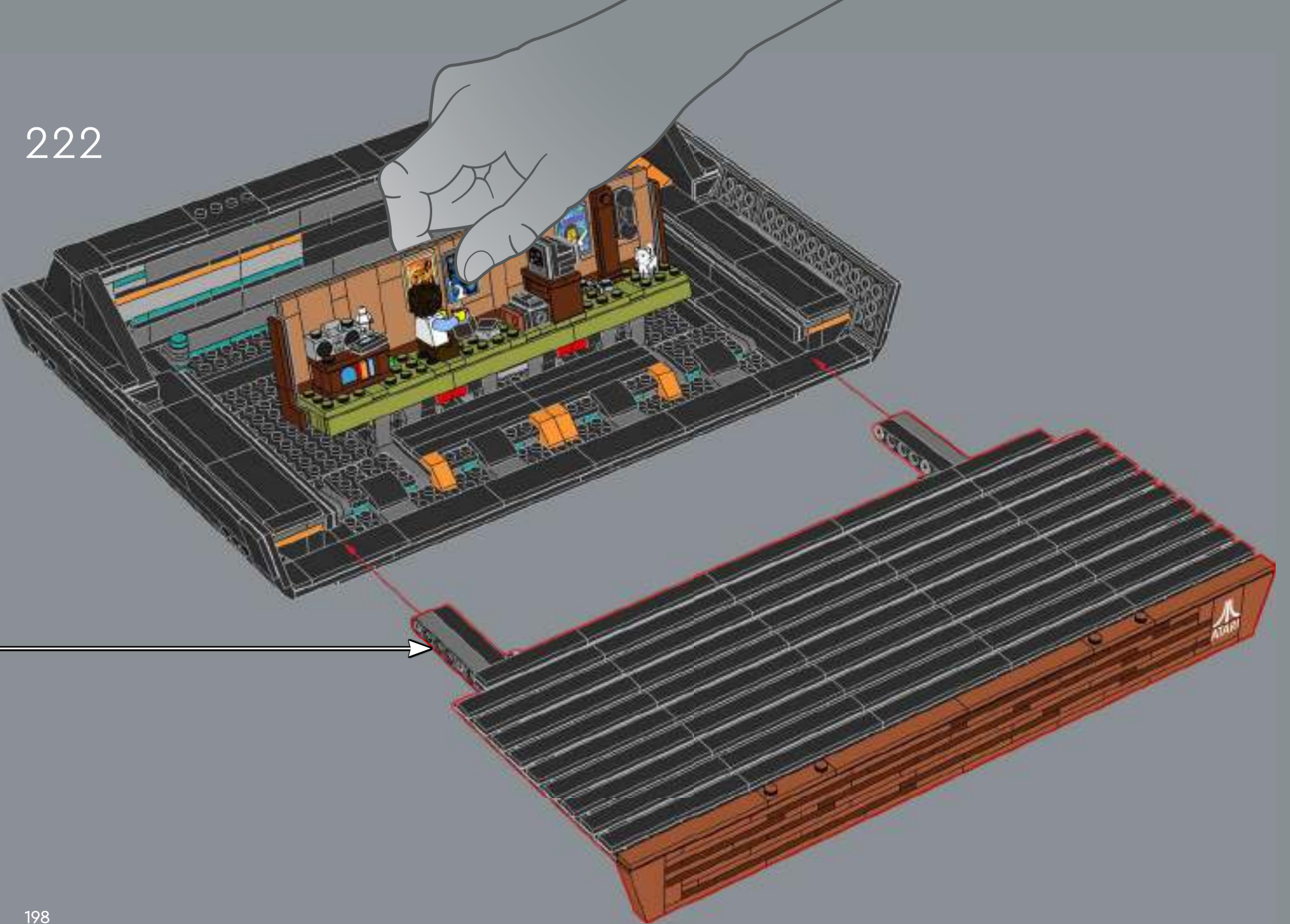

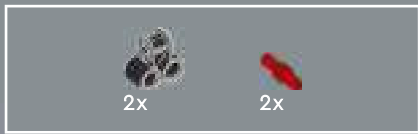

223

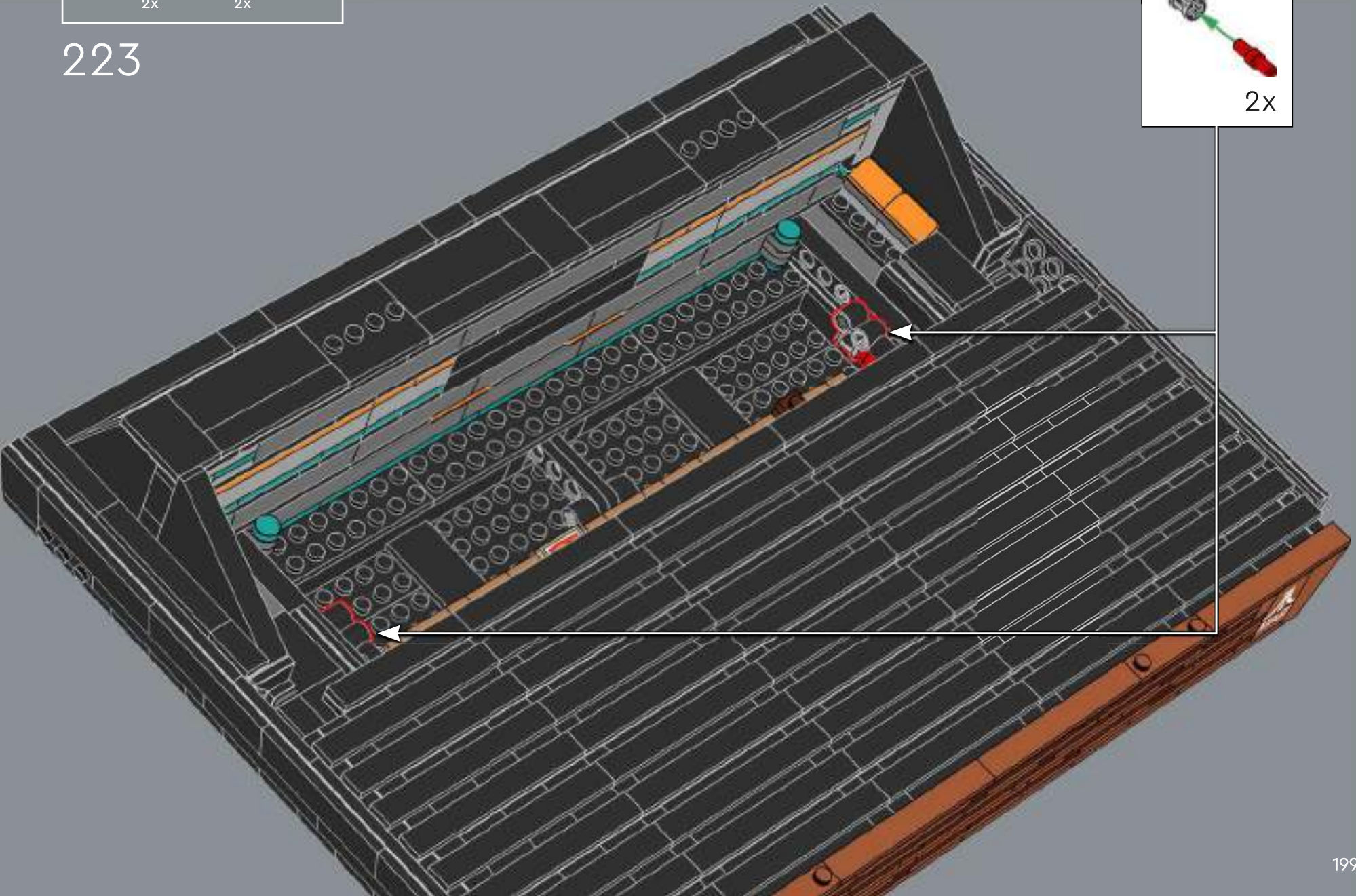
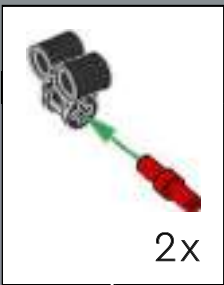





224

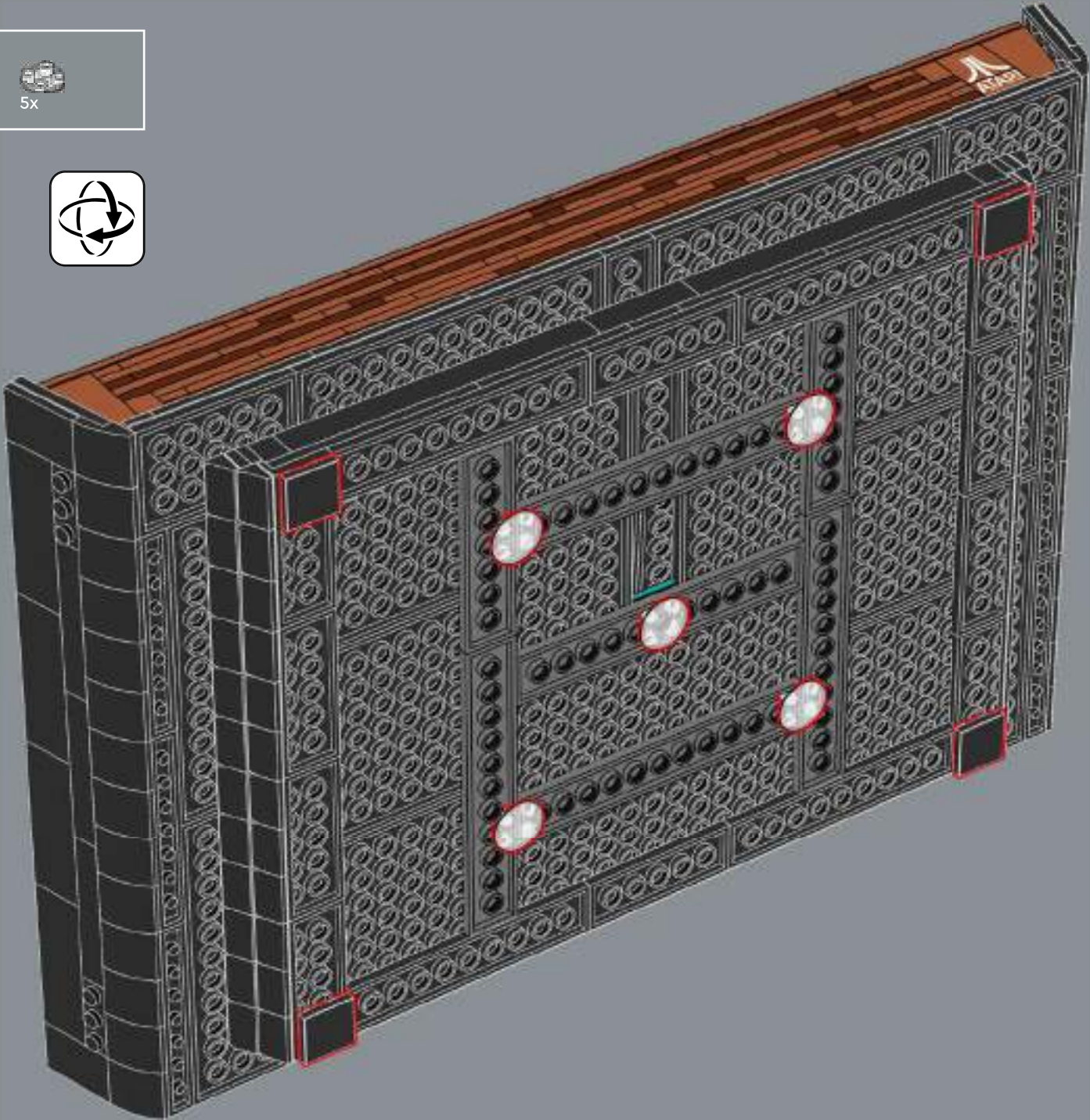

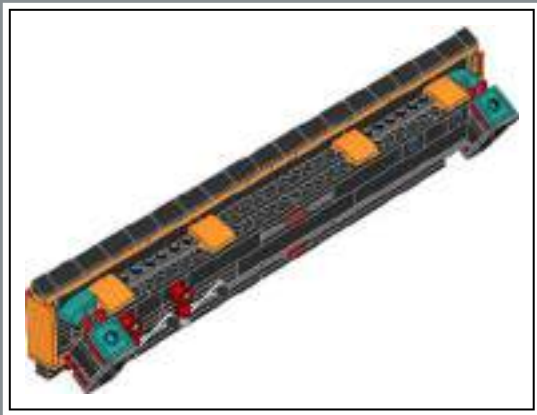

225

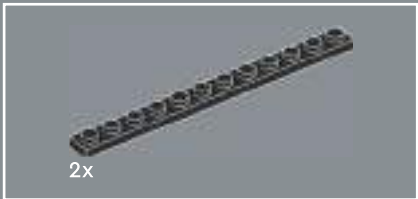
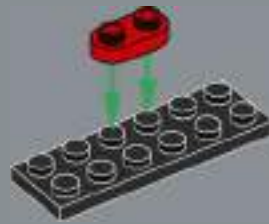

226

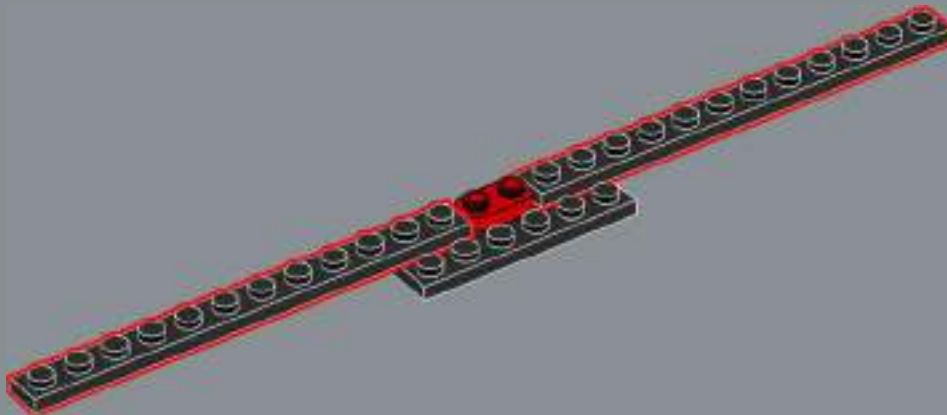

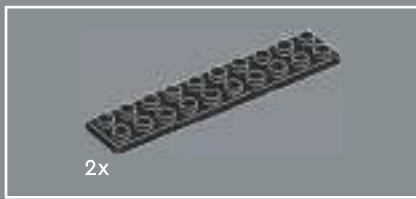

227

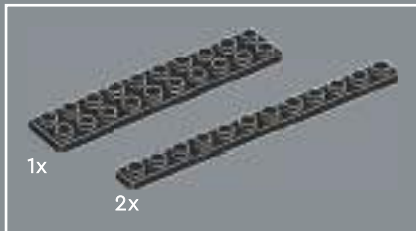
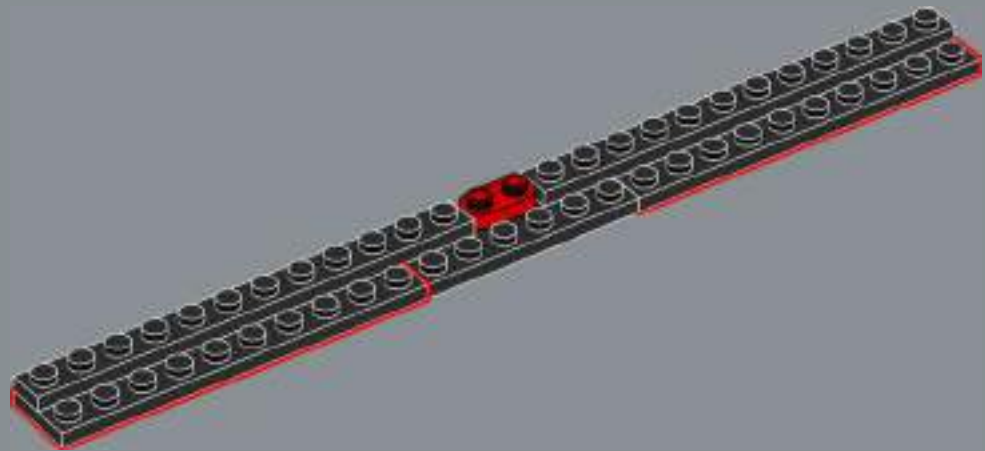

228

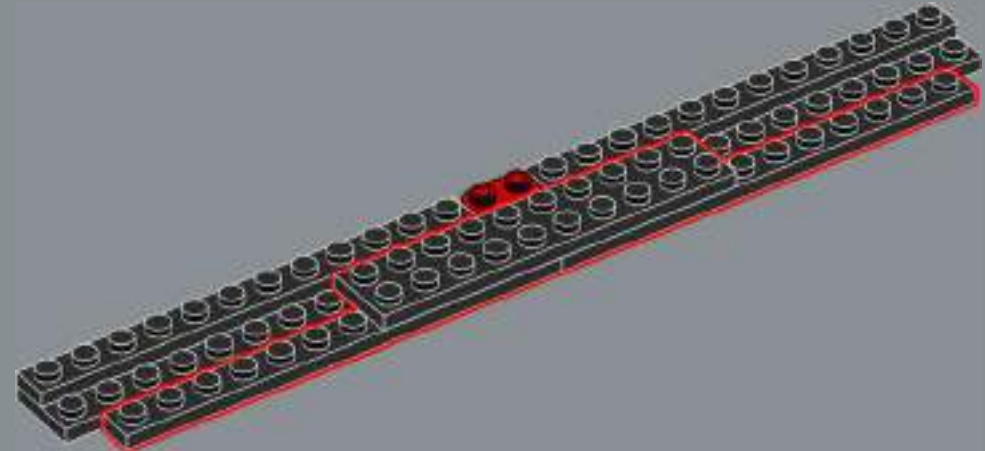

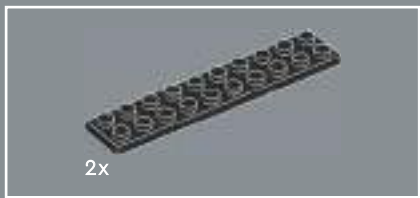

229

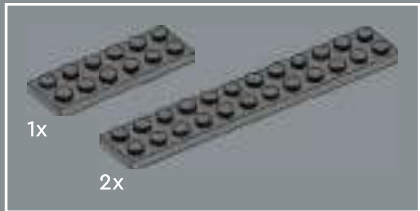
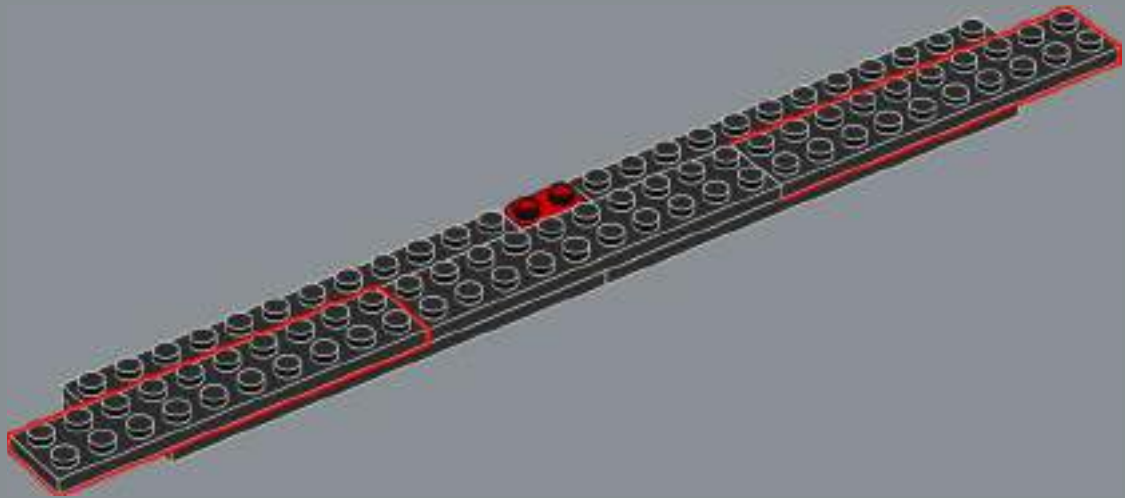

230

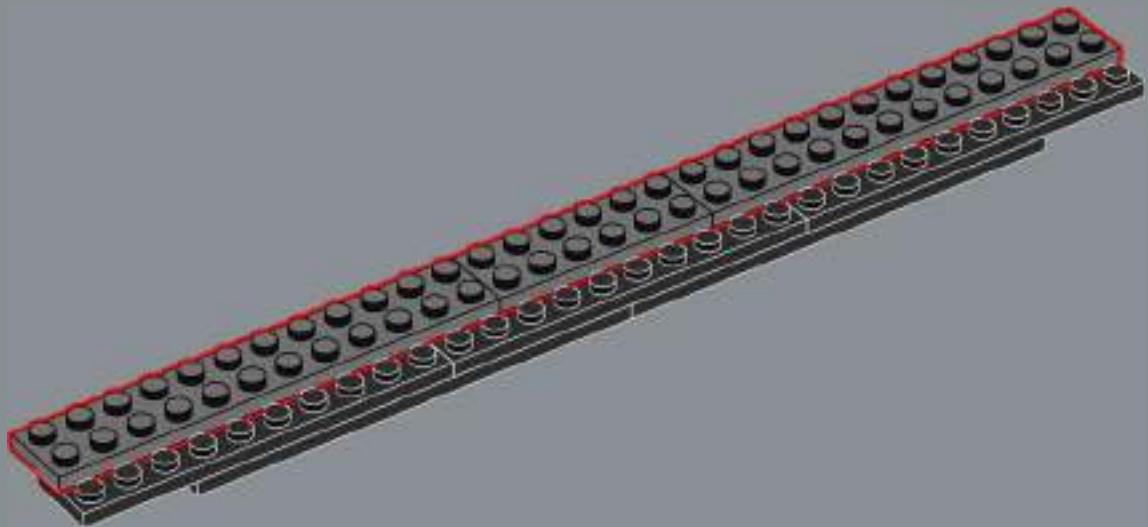

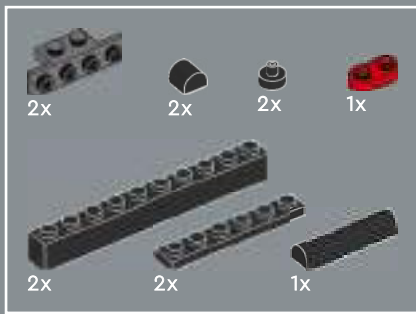

231

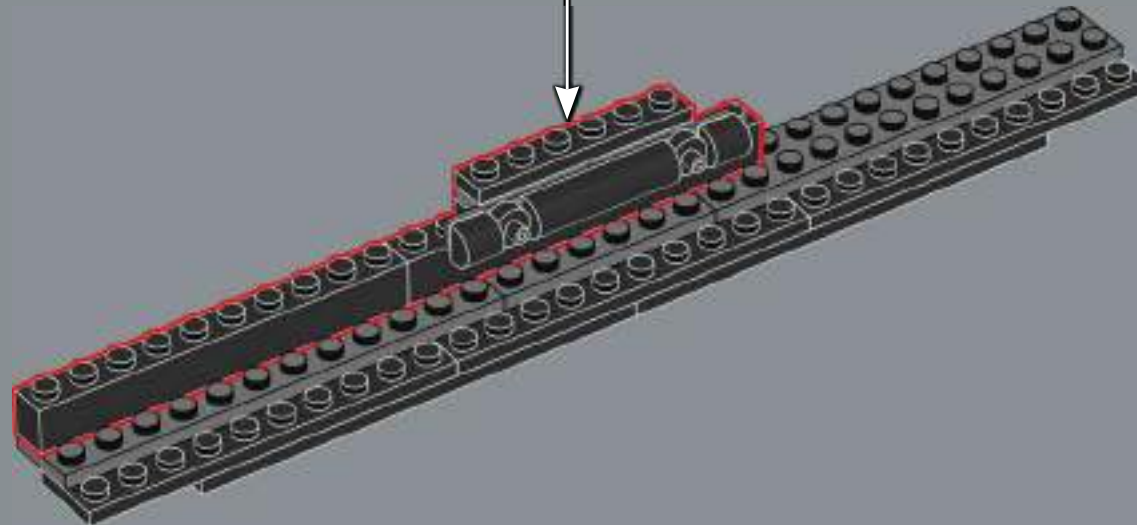

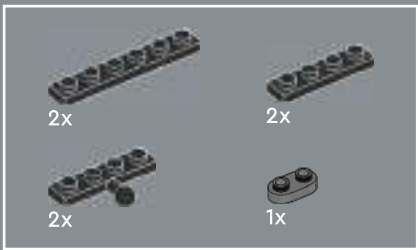

232

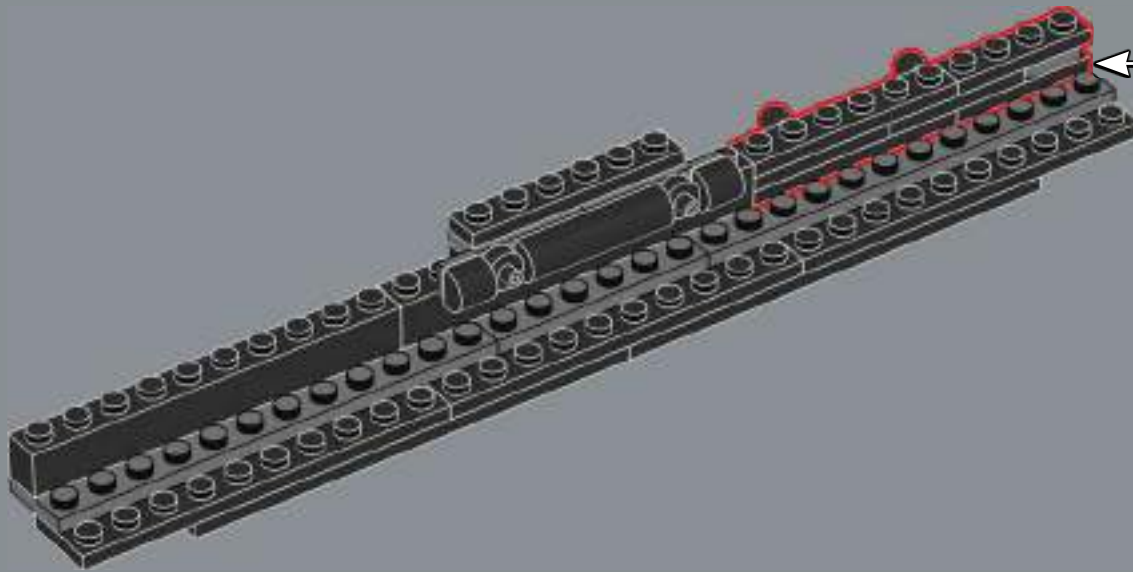
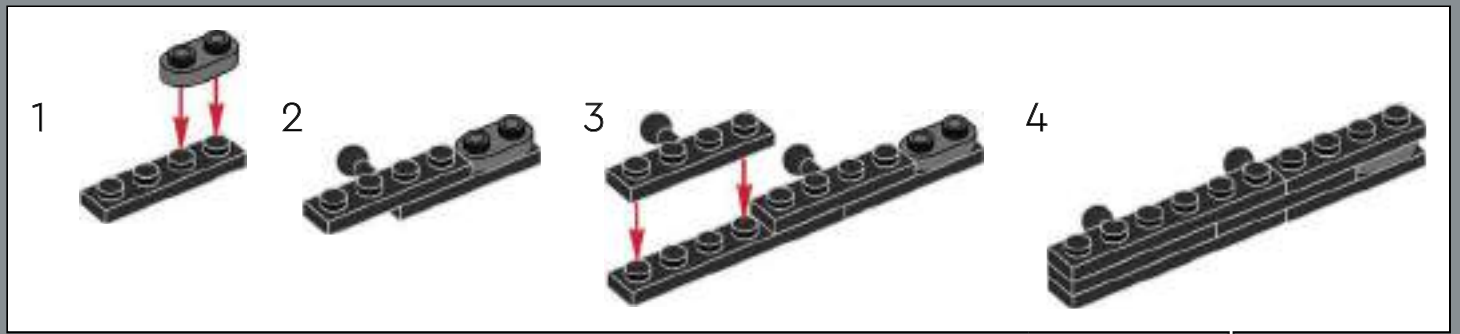



233

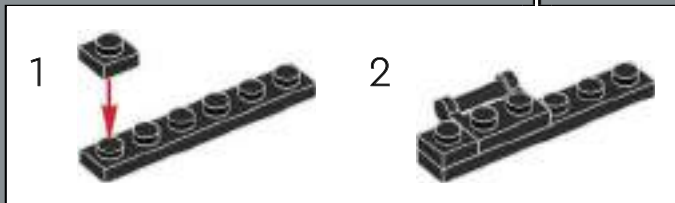
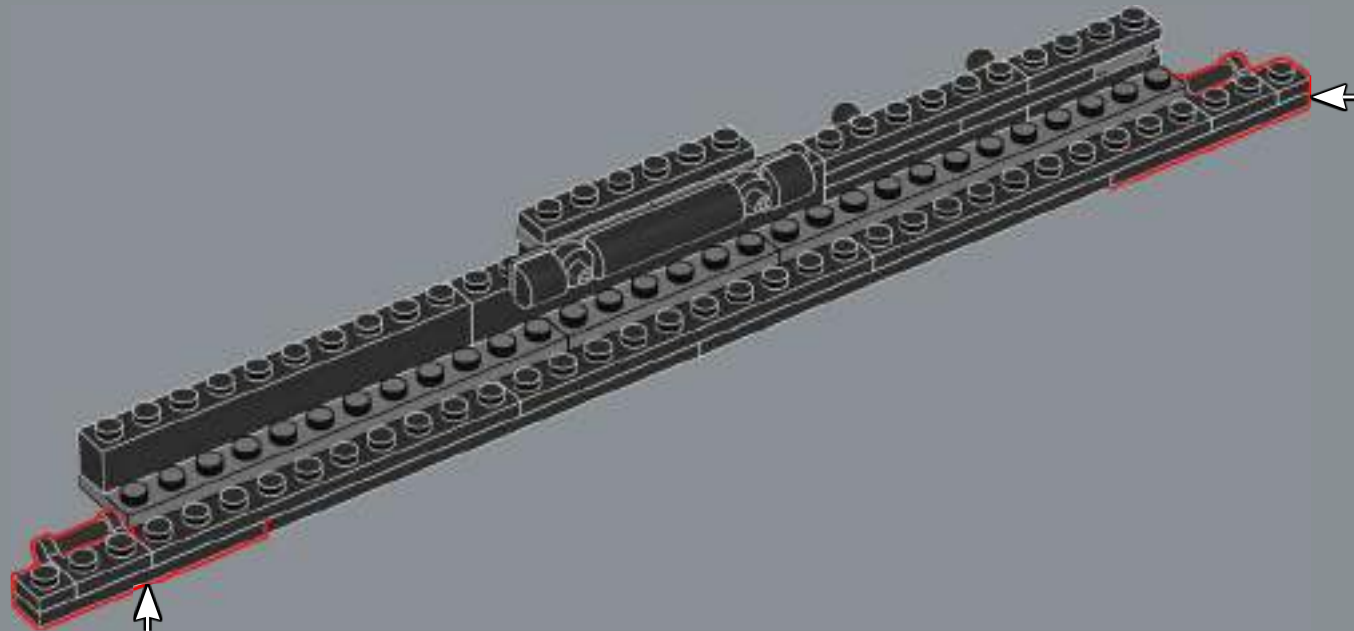
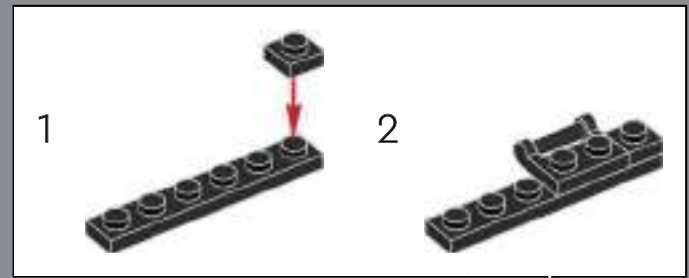



234

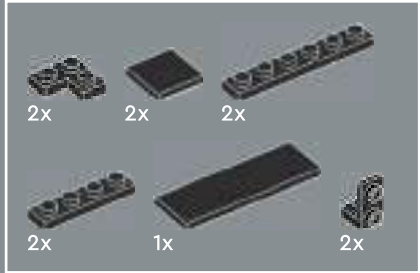
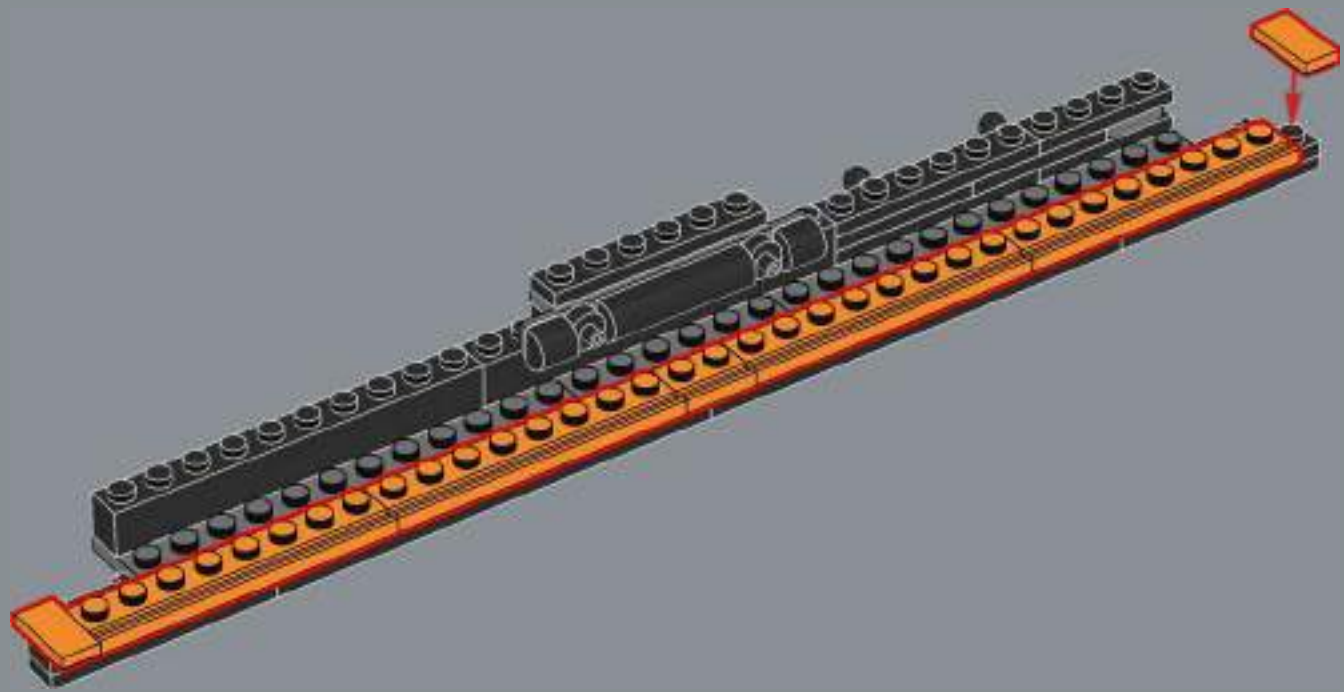

235

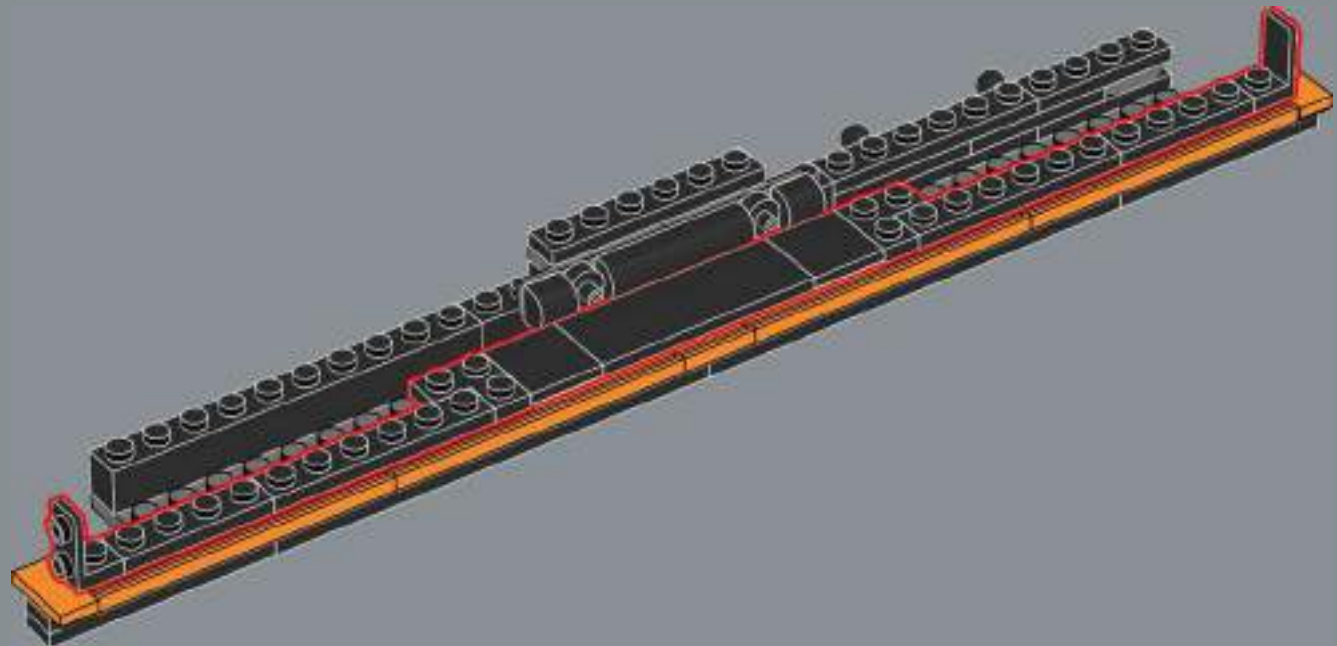

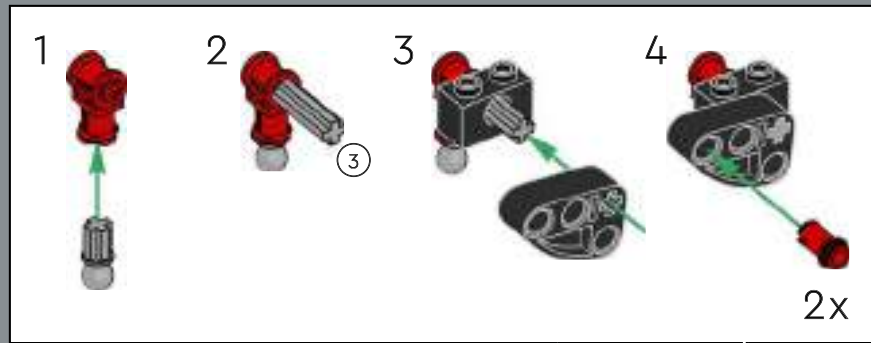
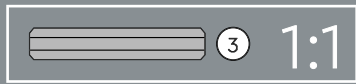
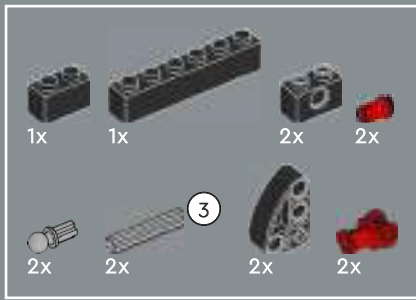

236

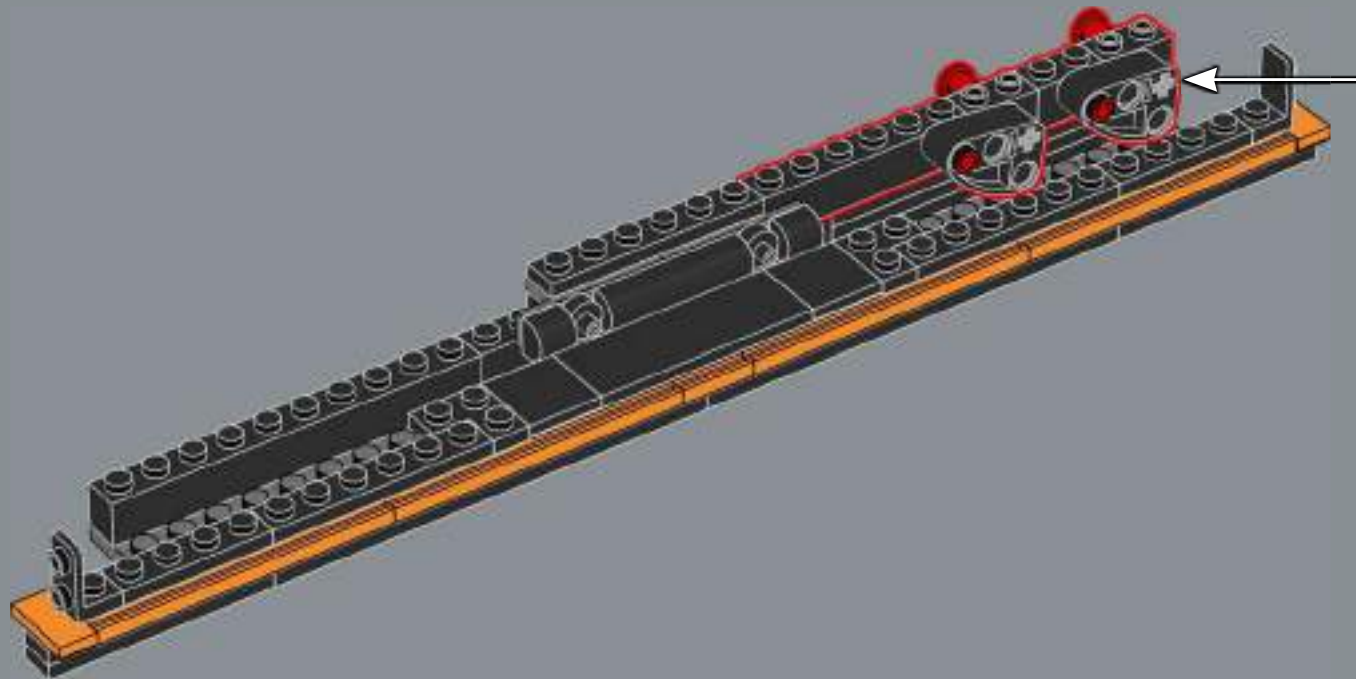

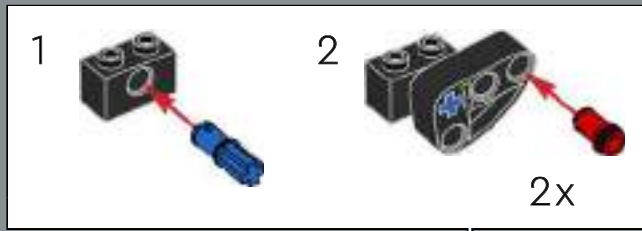
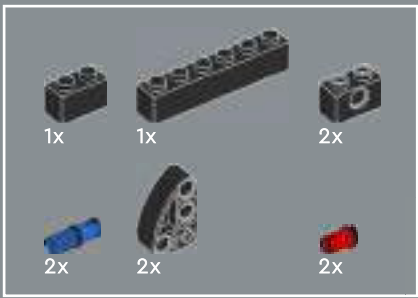

237

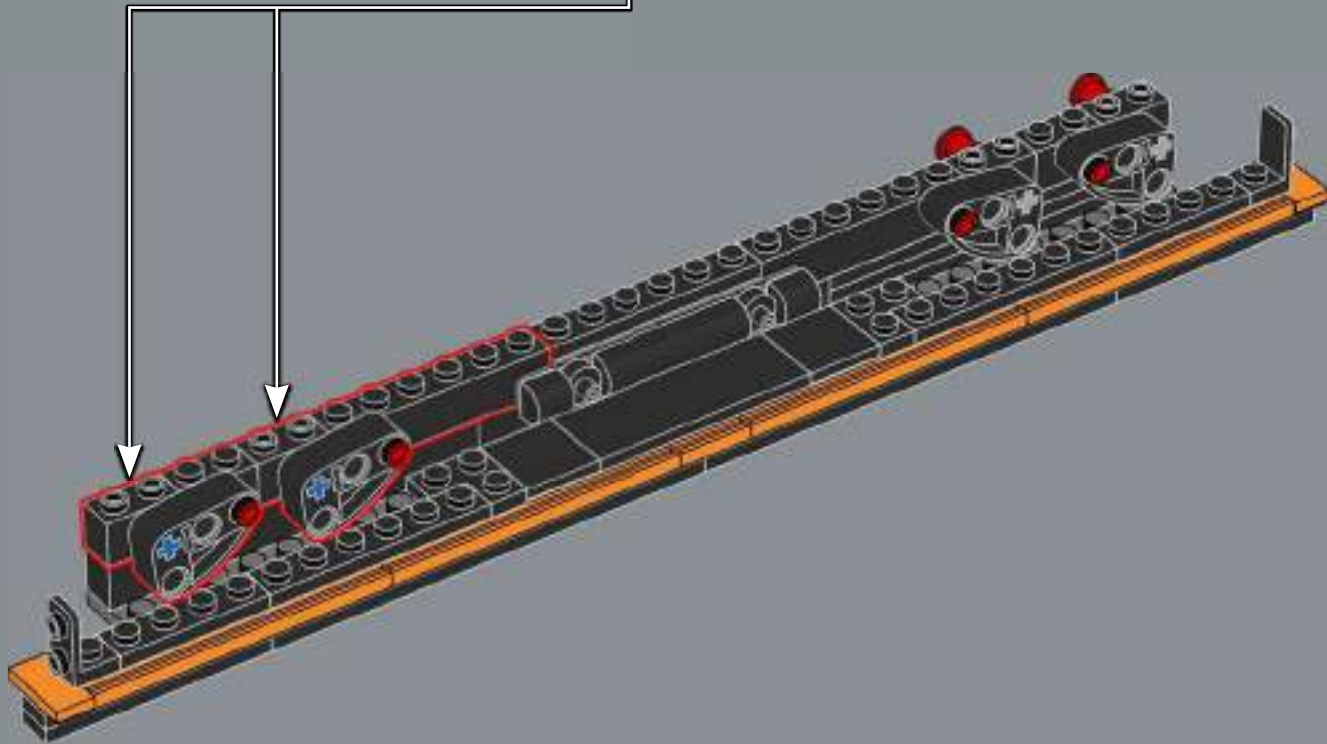

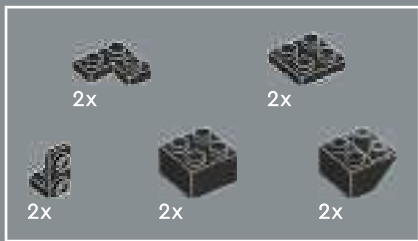

238

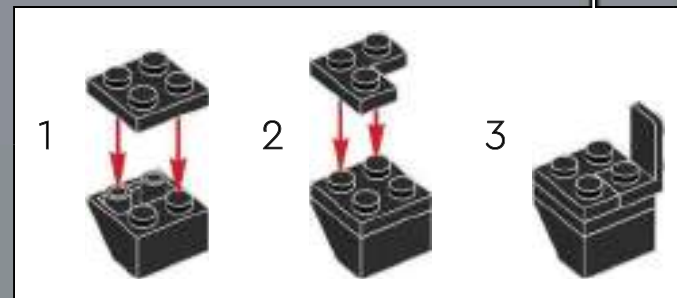
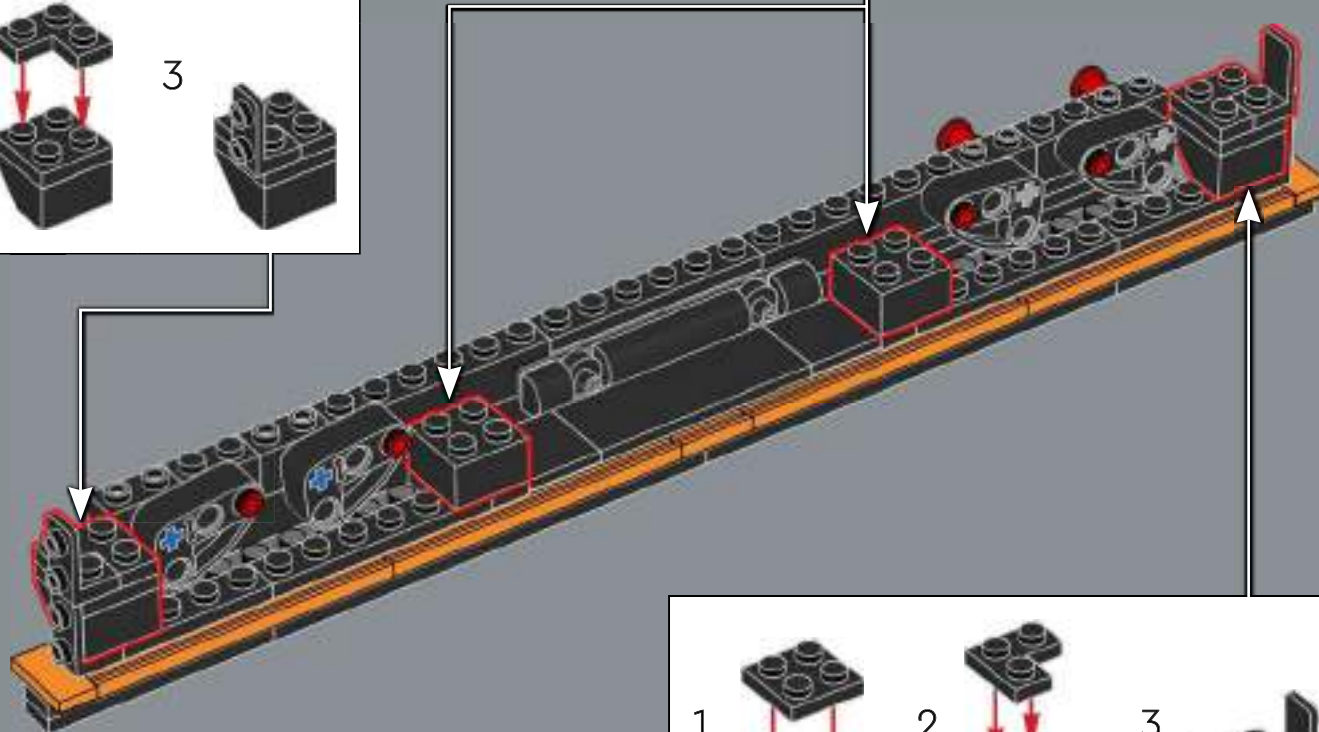
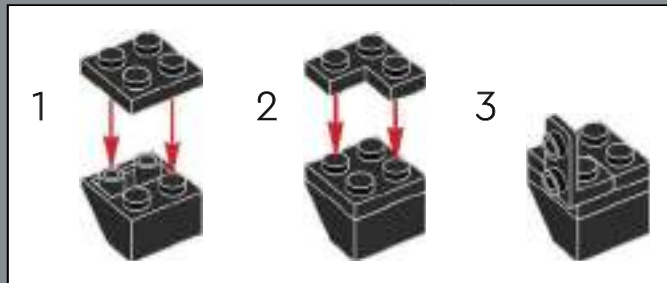
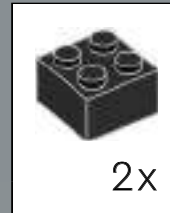

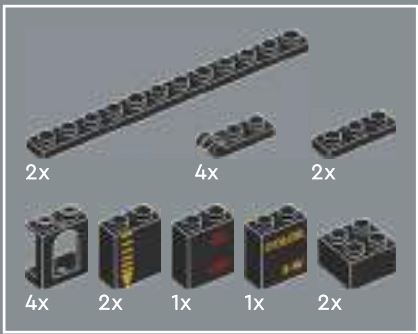

239

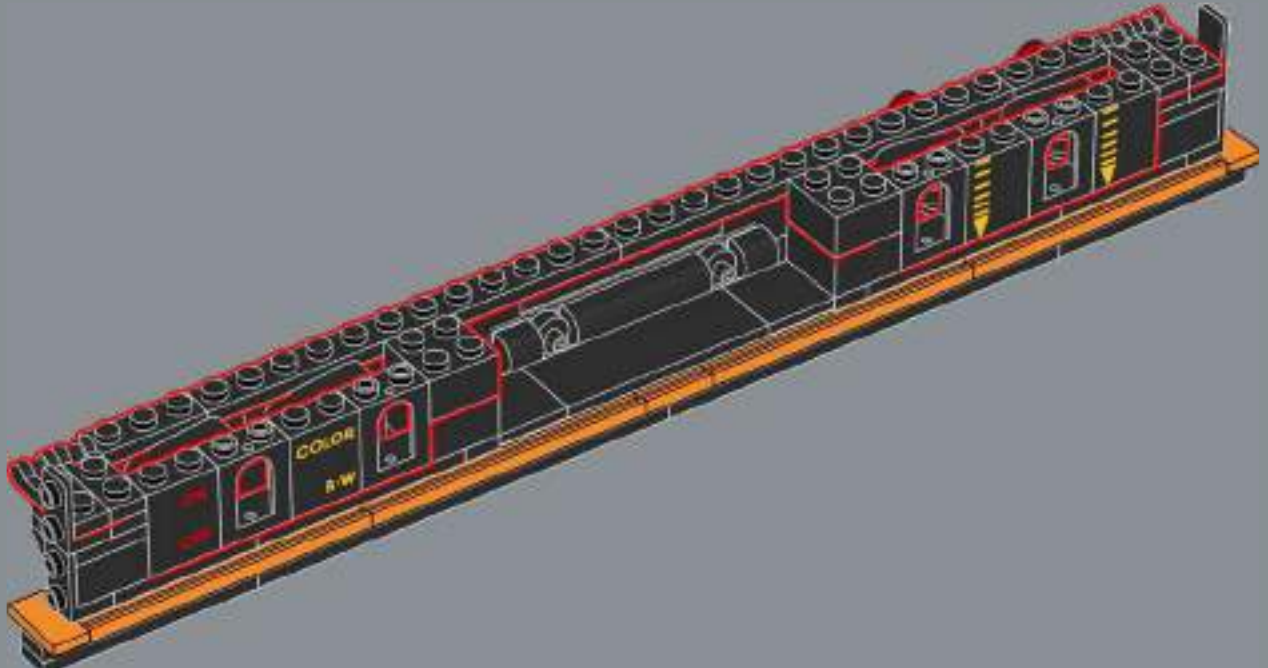

240

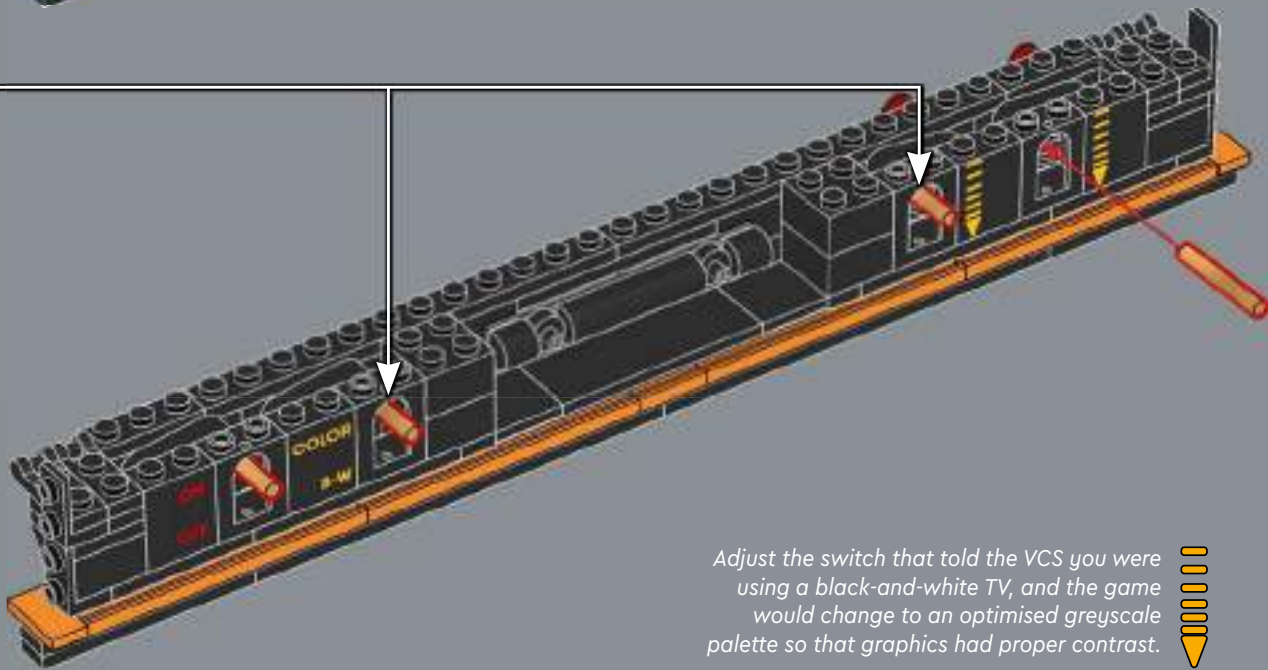

Adjust the switch that told the VCS you were using a black-and-white TV, and the game would change to an optimised greyscale palette so that graphics had proper contrast.



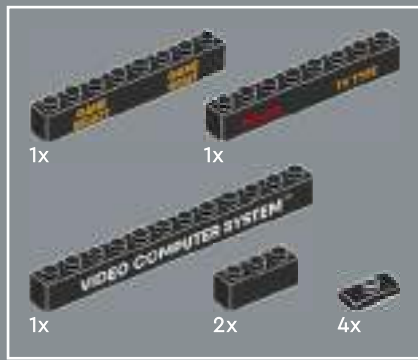

241

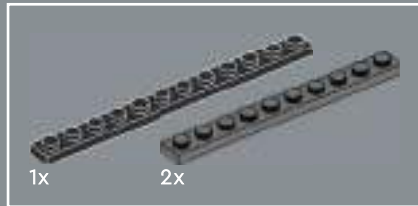
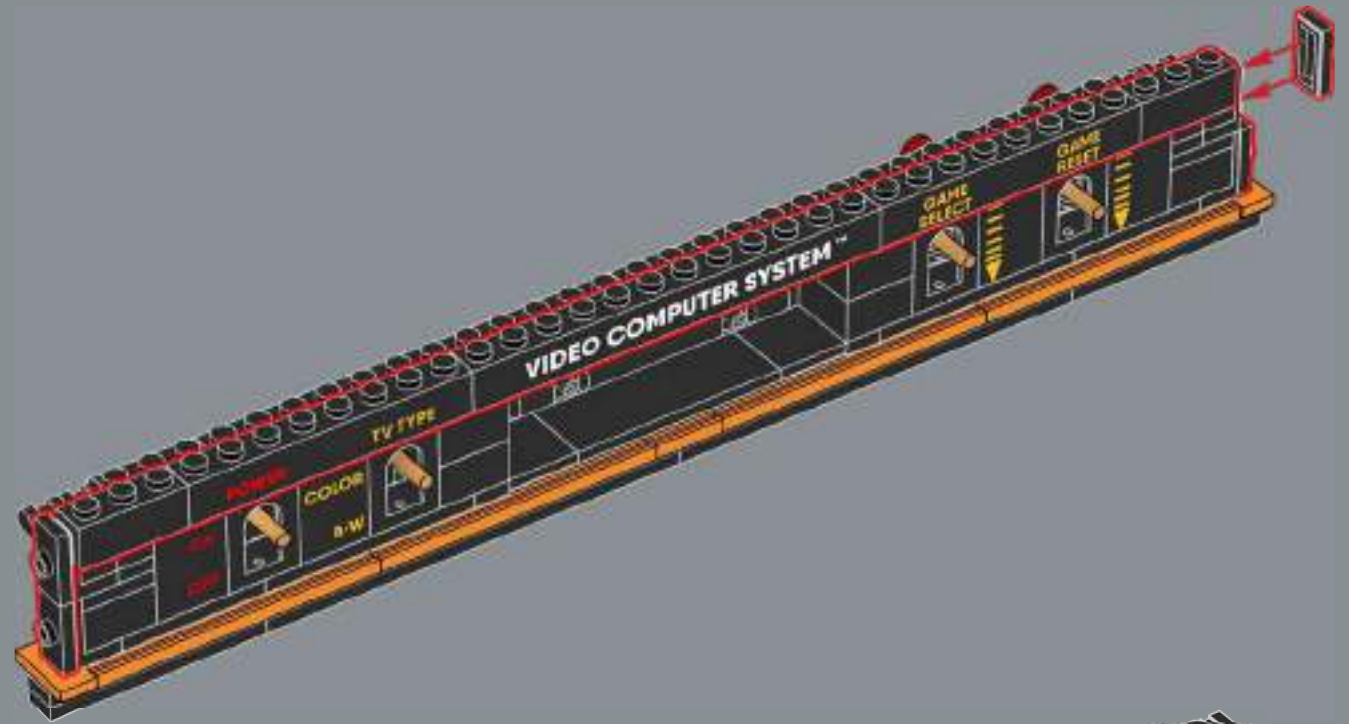

242

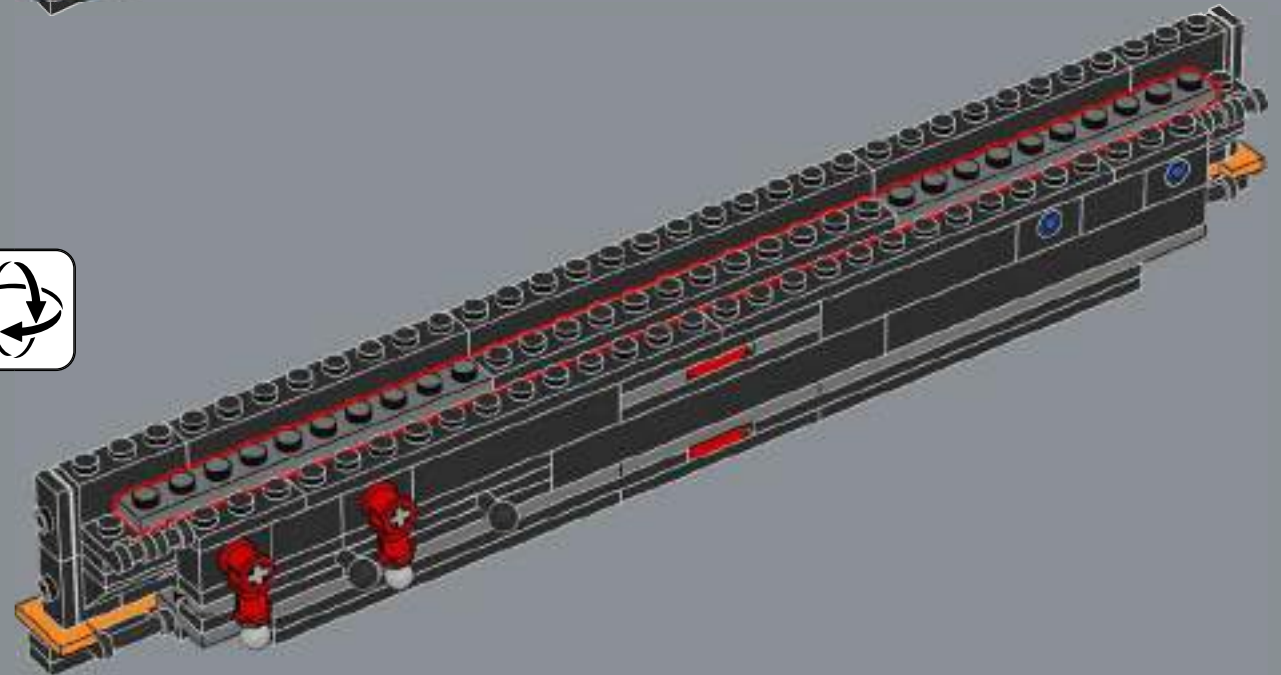

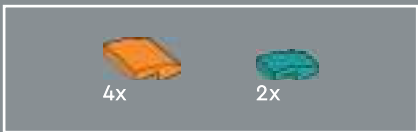

243

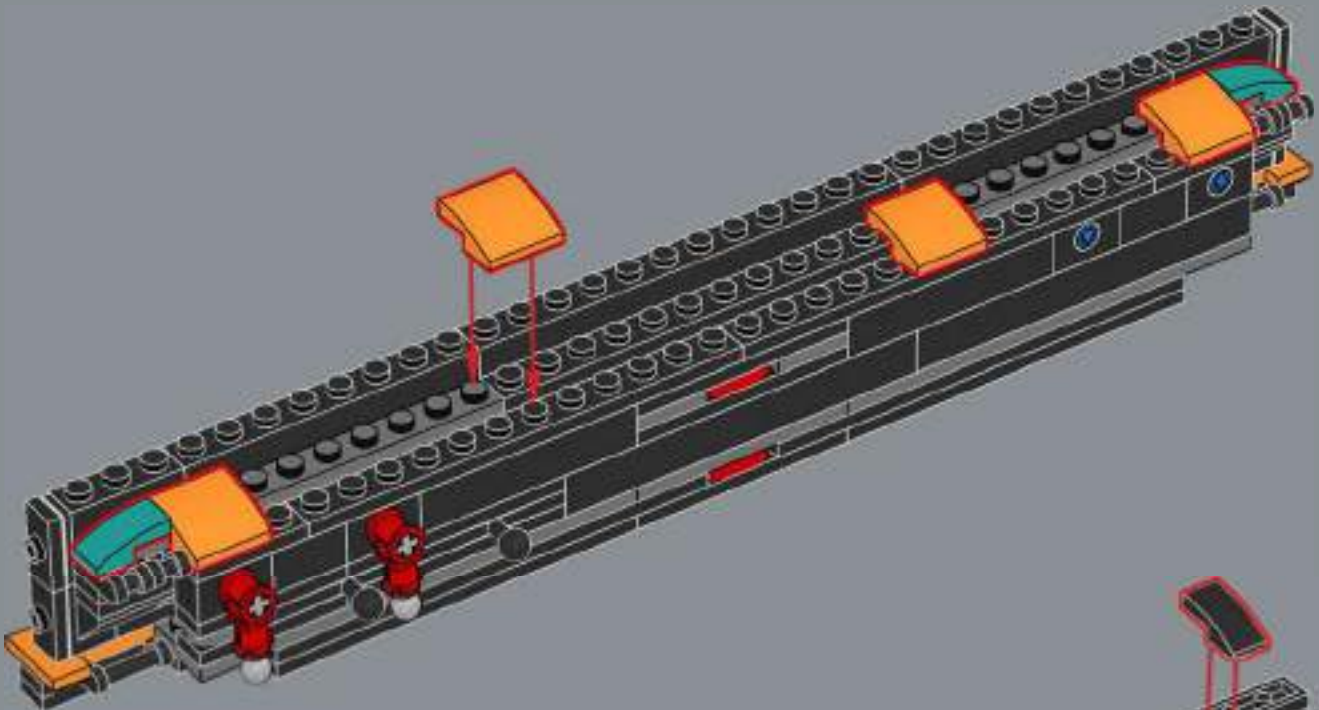

244

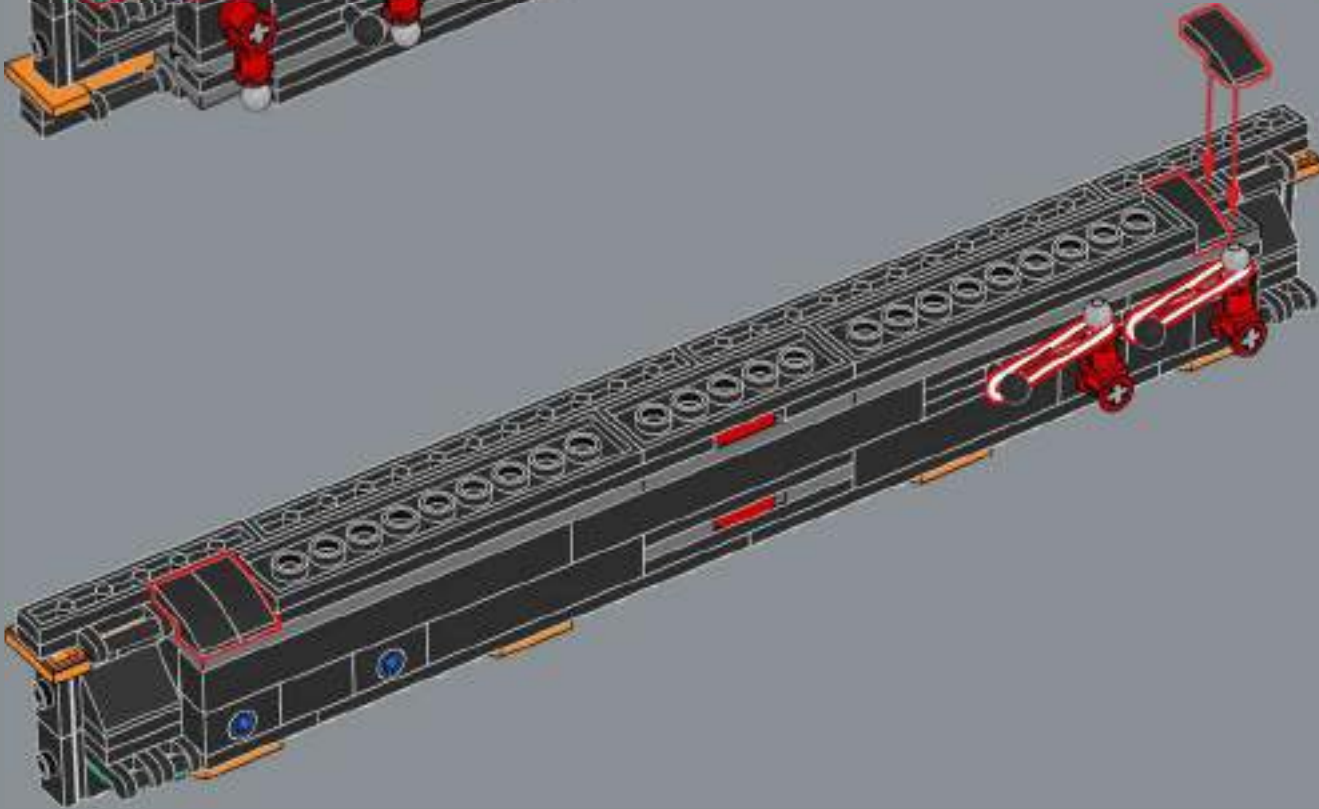



245

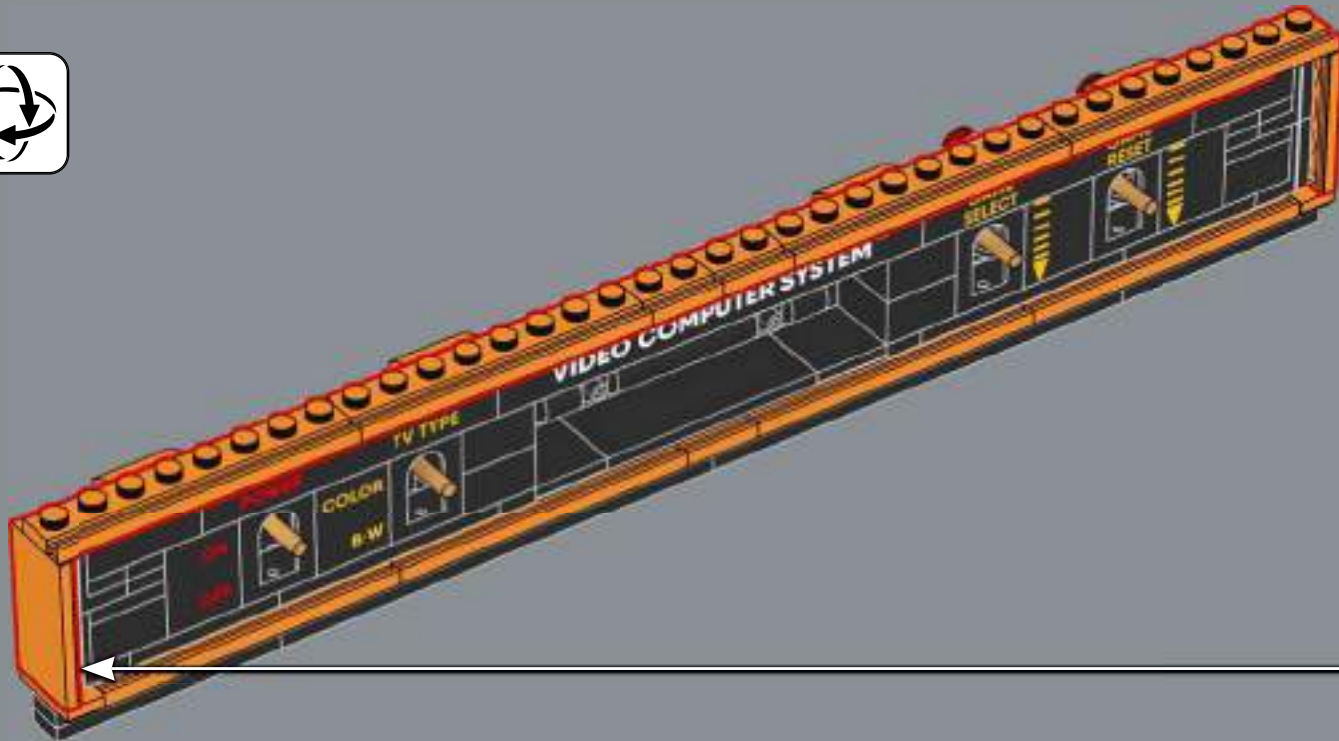
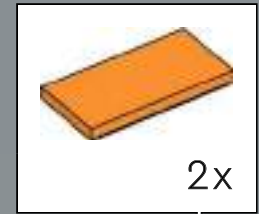



2x



17x

246

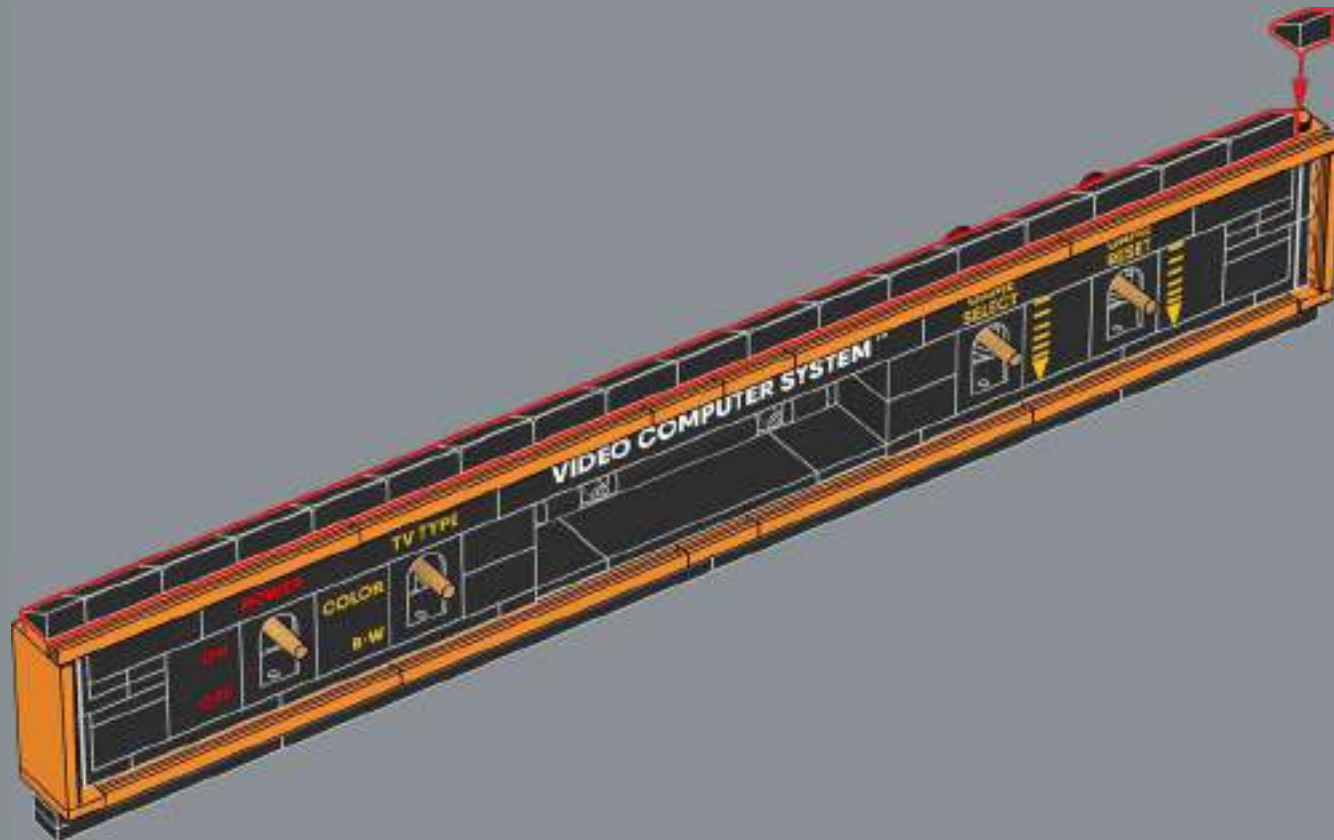



247

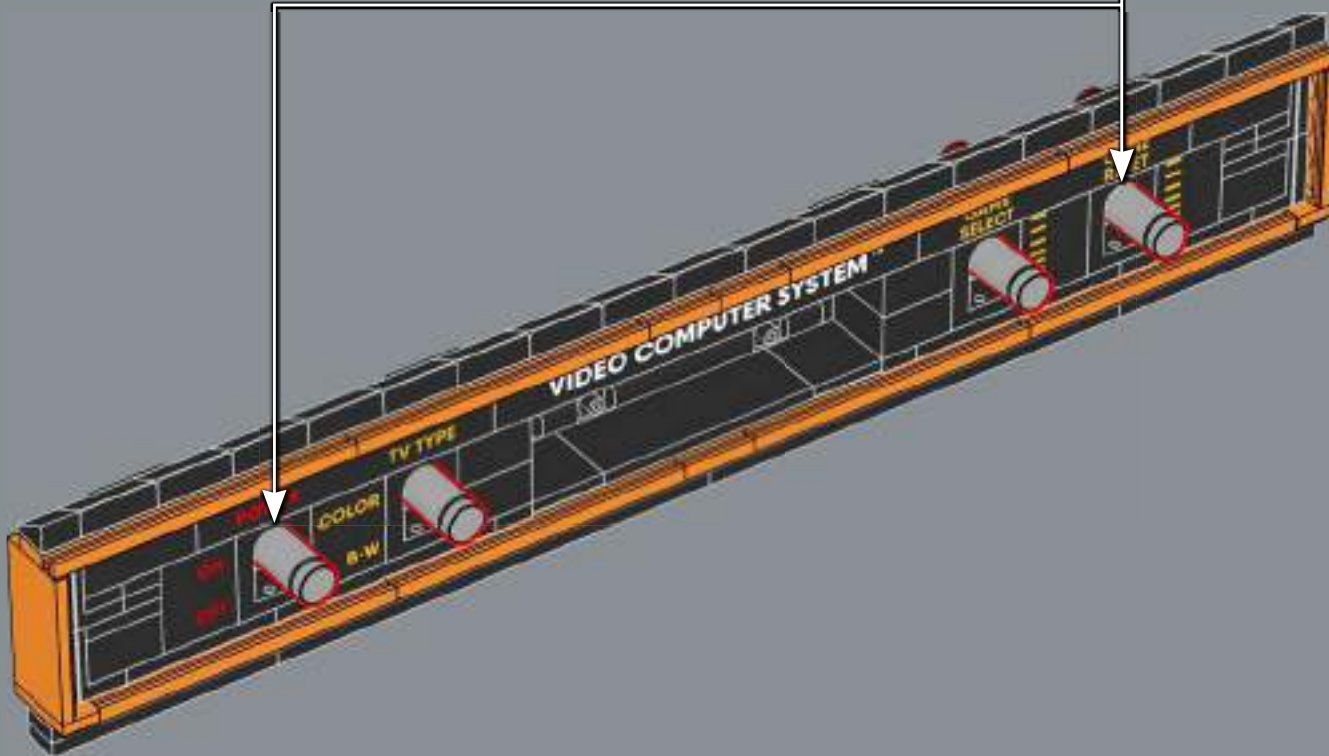
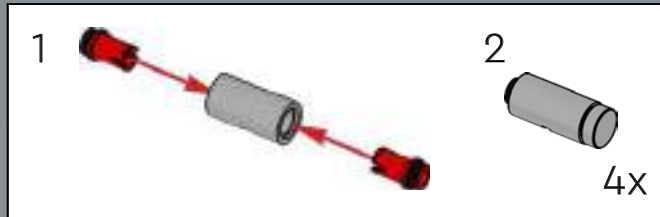



2x



2x



2x



2x



4x



2x



4x



4x



4x

248

1

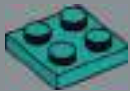

2

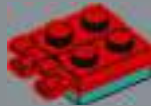

3



4



5

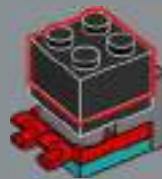

6



7

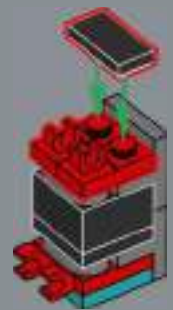

2x

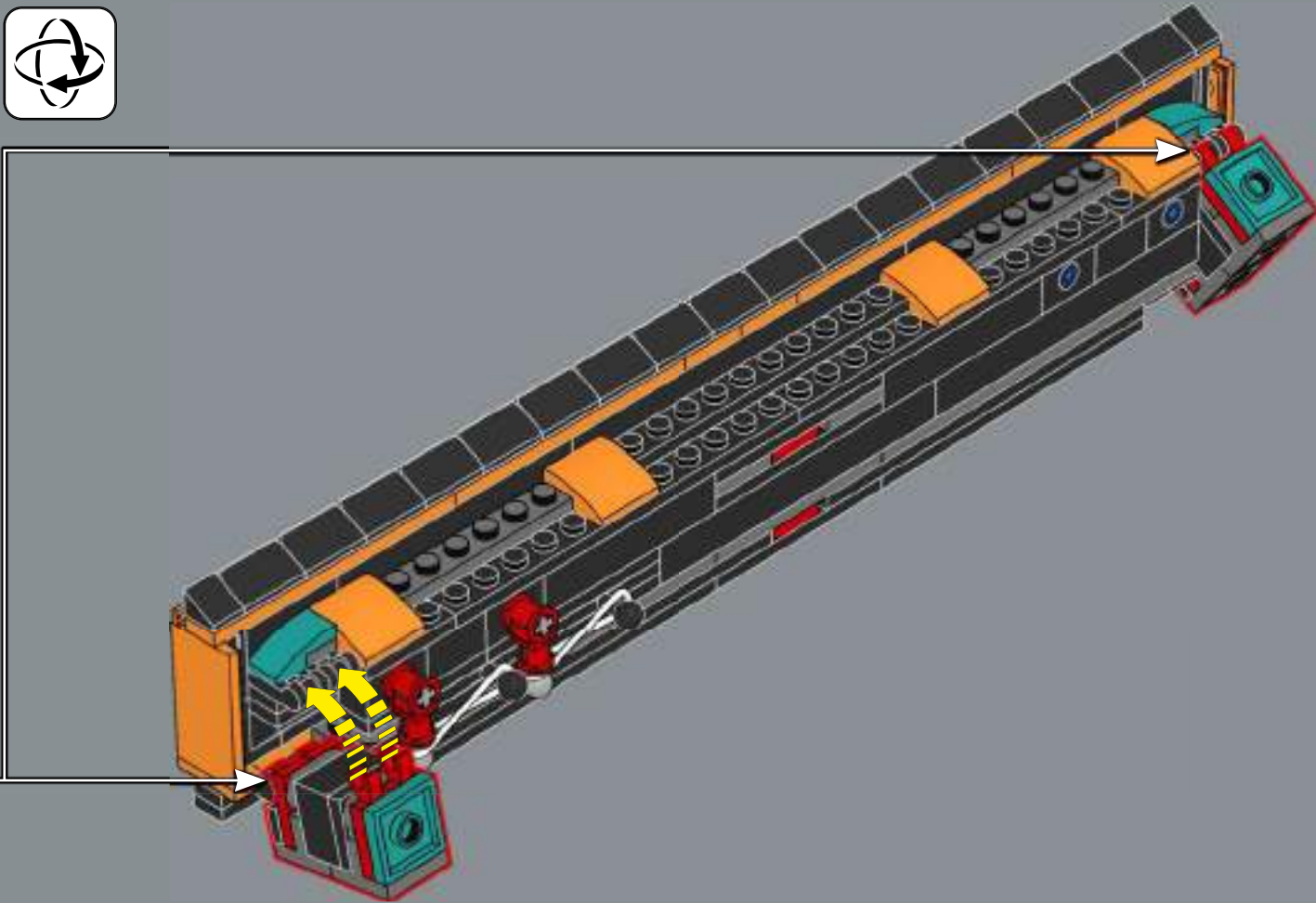

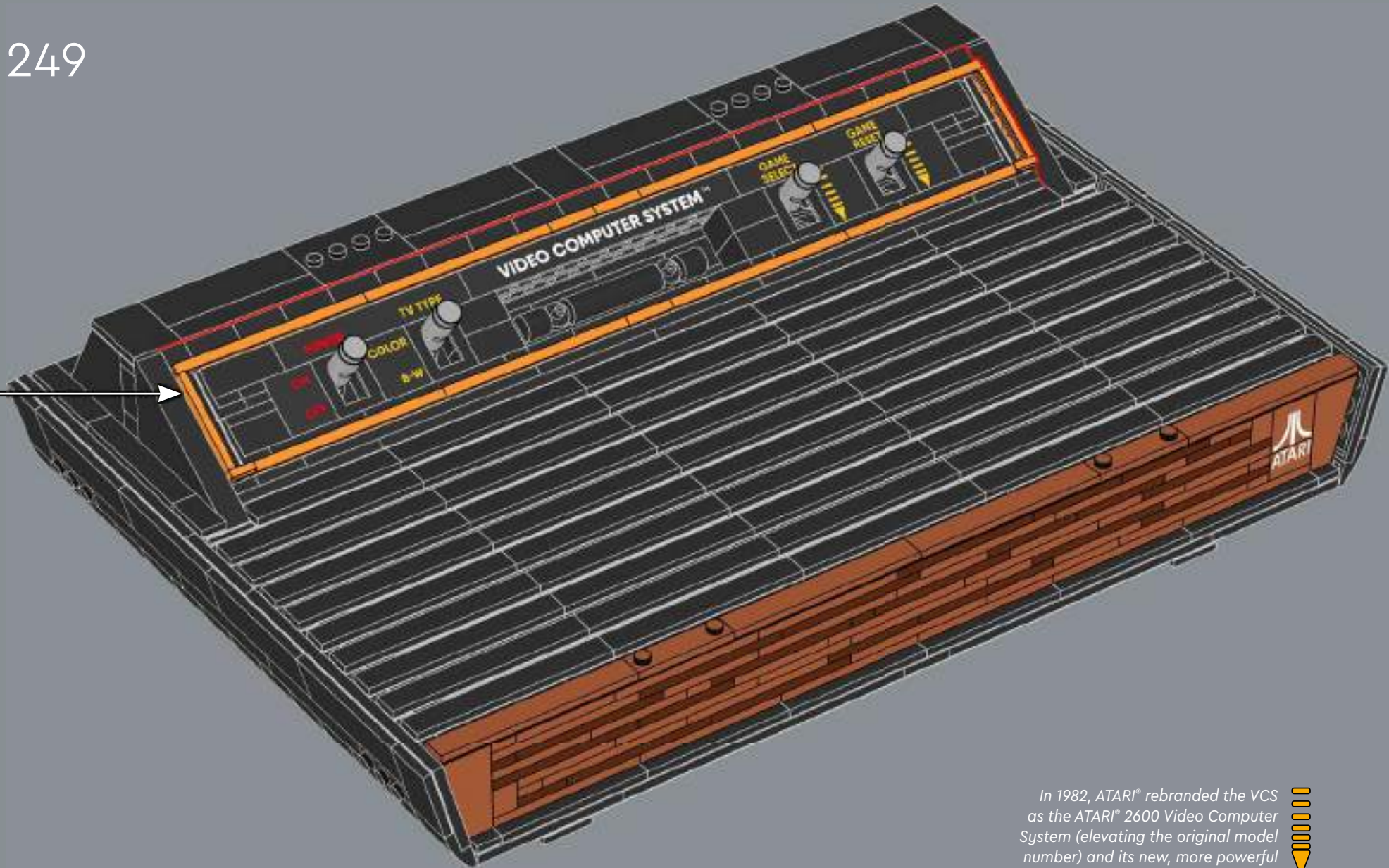

In 1982, ATARI® rebranded the VCS as the ATARI® 2600 Video Computer System (elevating the original model number) and its new, more powerful sibling was introduced as the ATARI® 5200 Video Computer System.



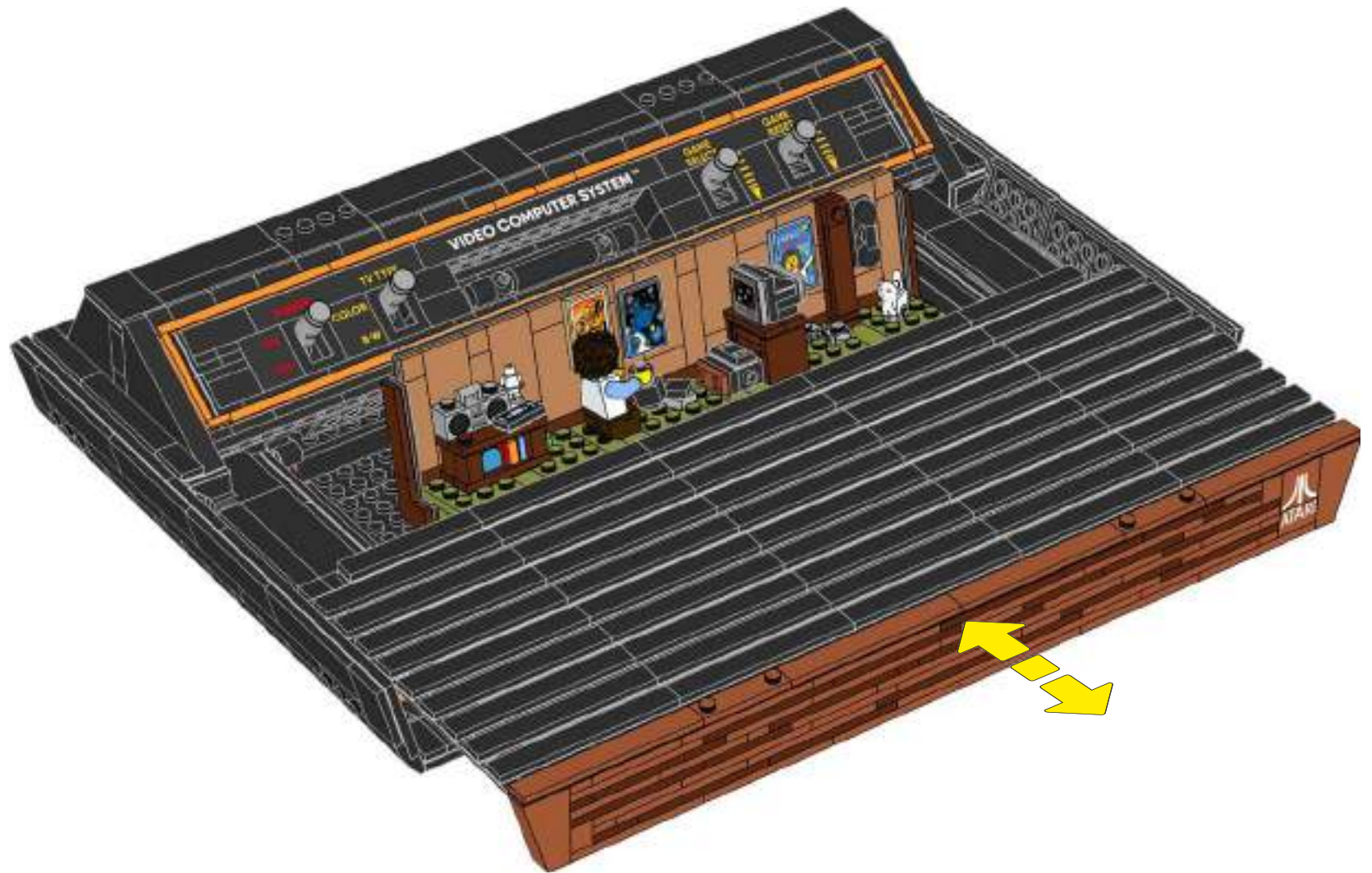

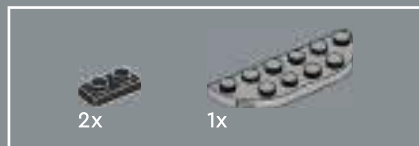
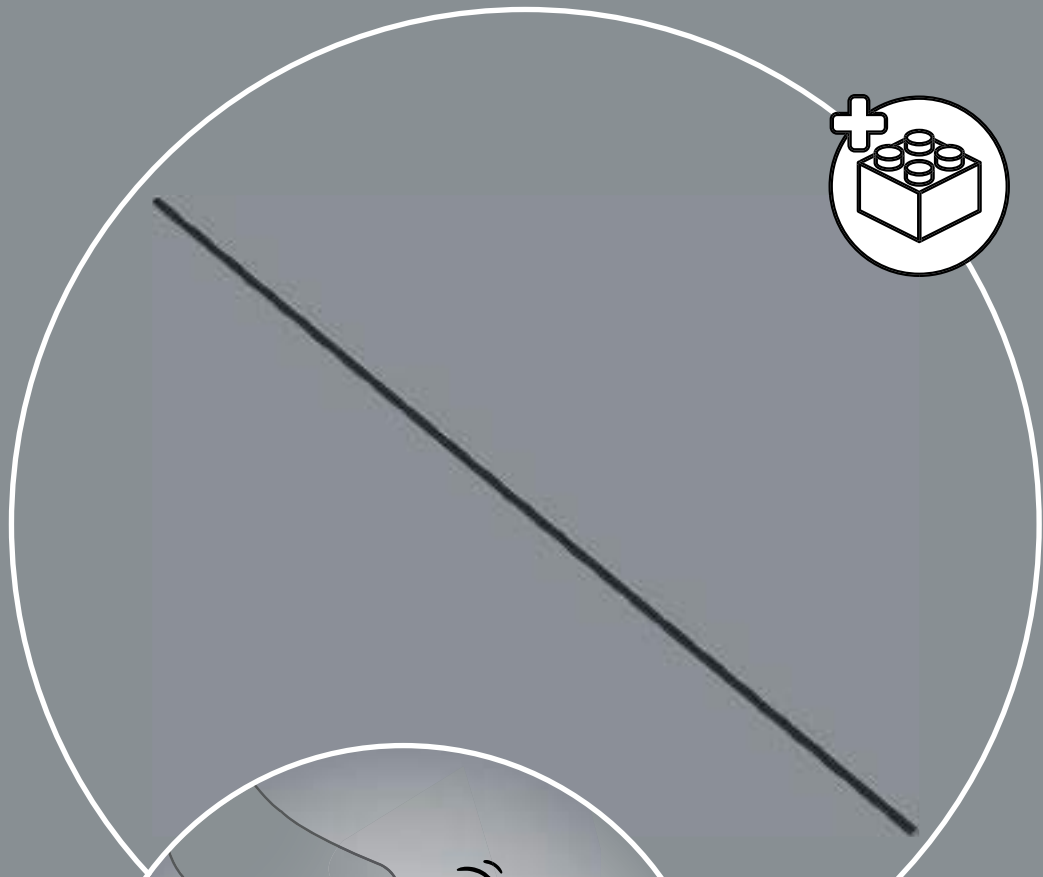

1

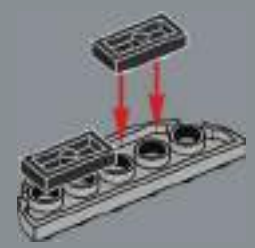

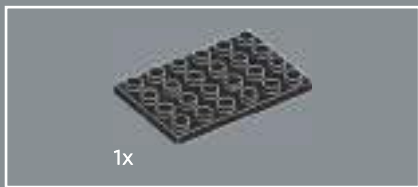

2

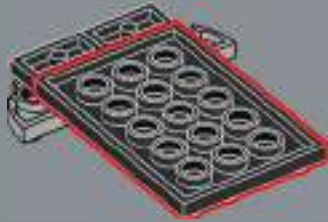

3

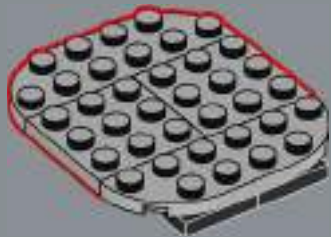

4

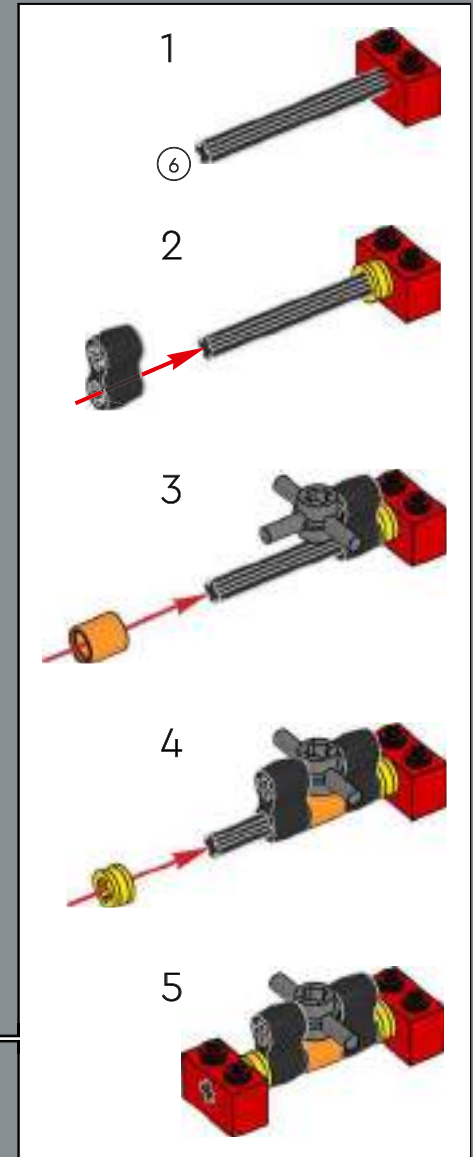



5

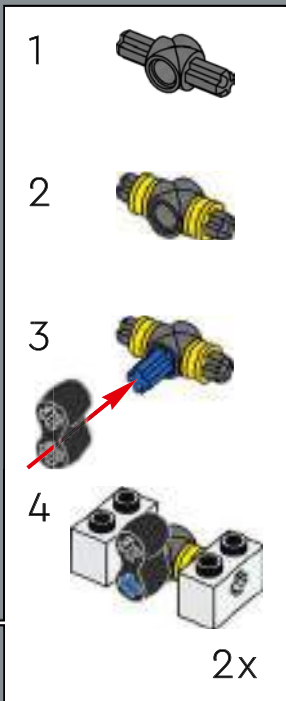
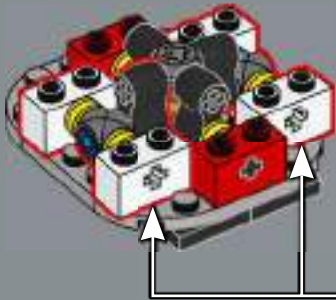

2x



6

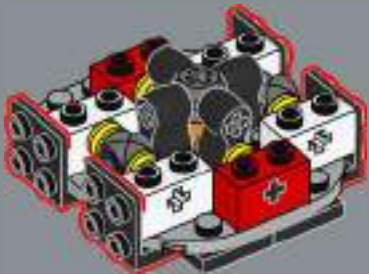

7

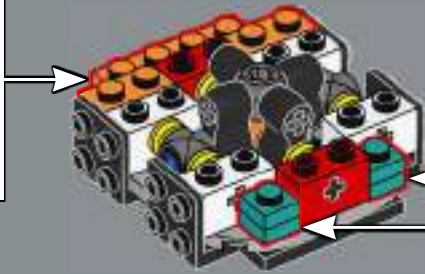
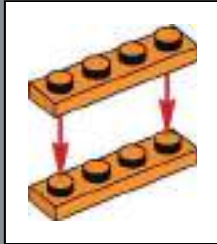

2x



8

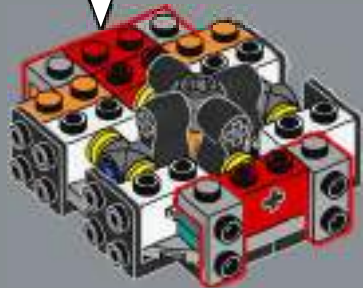

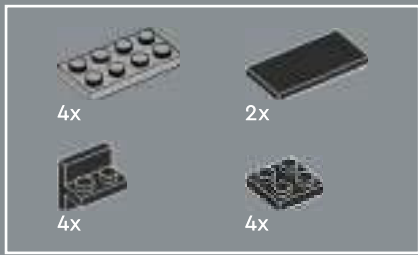

9

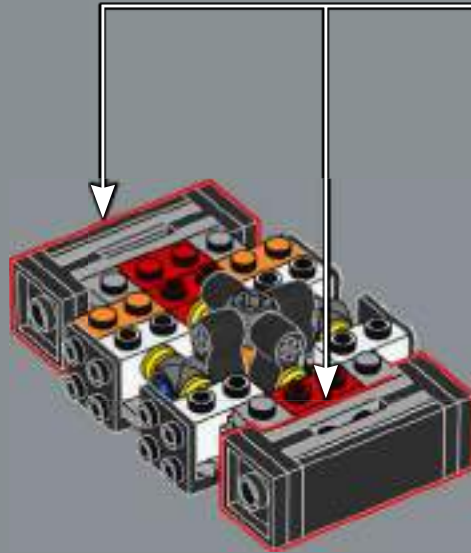
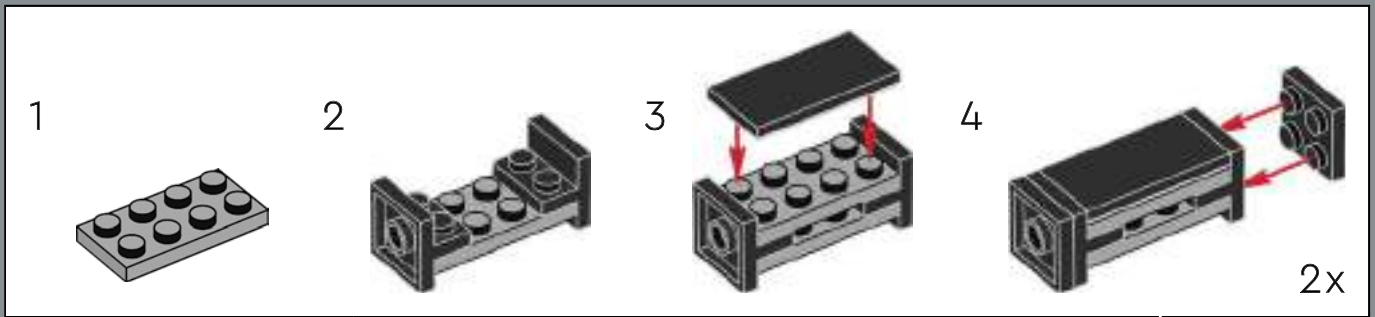



10

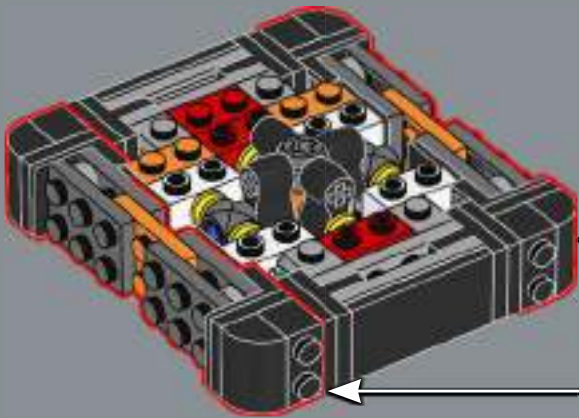
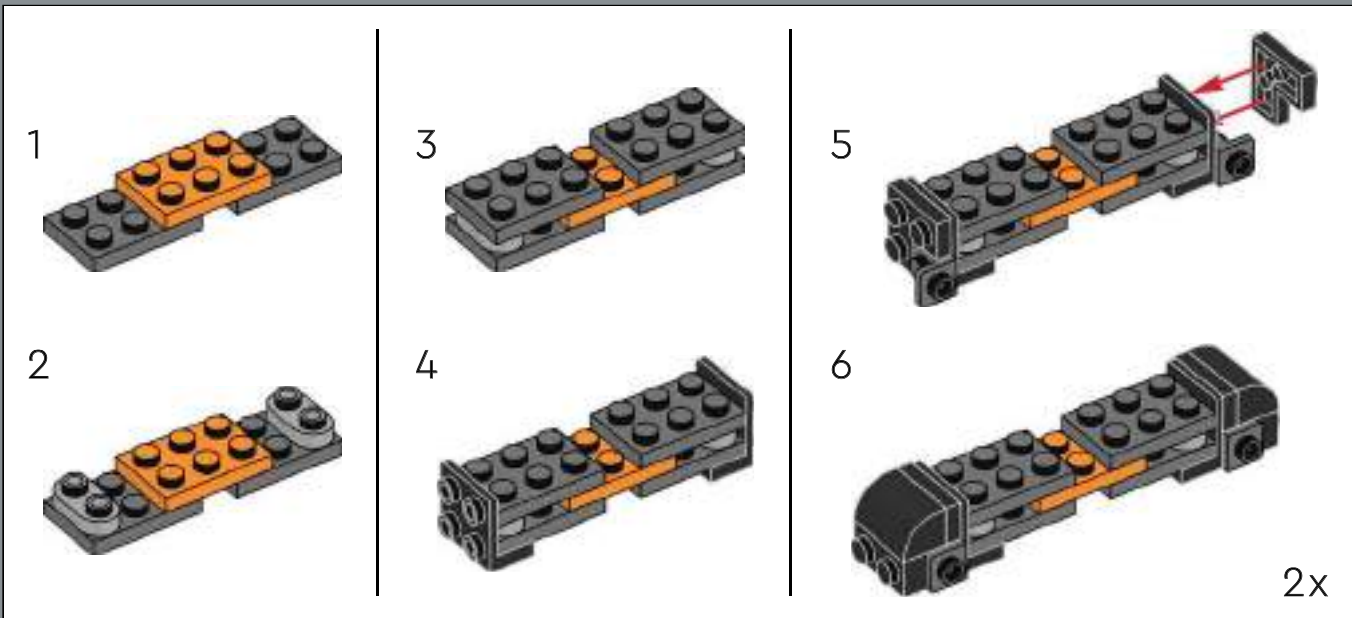



11

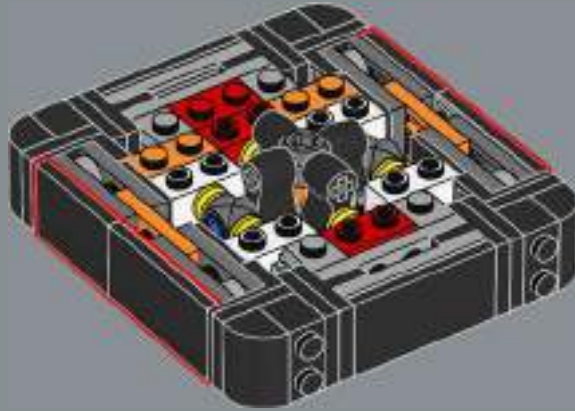

12

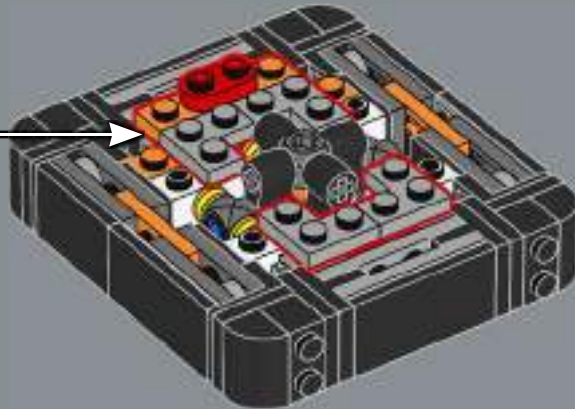
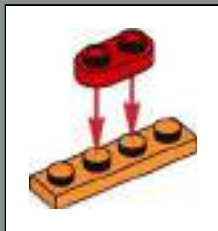

13

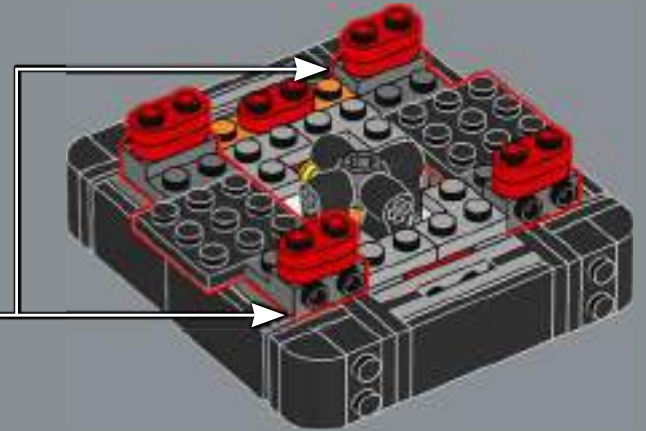
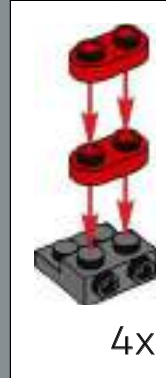

14

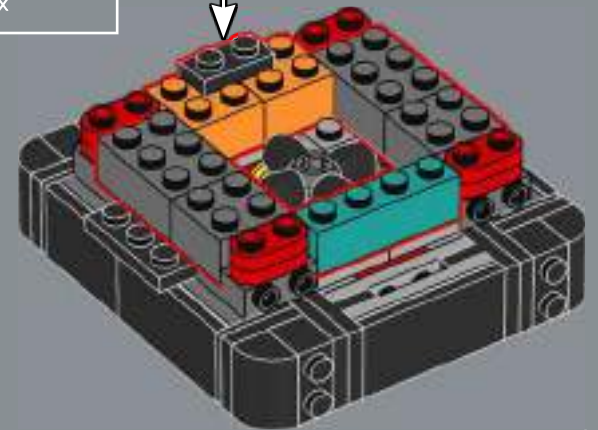

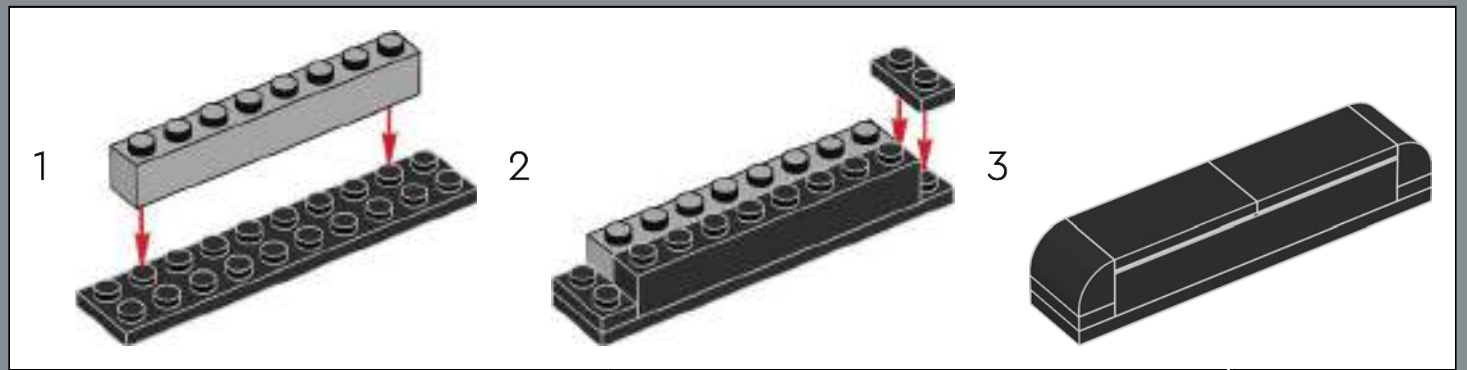
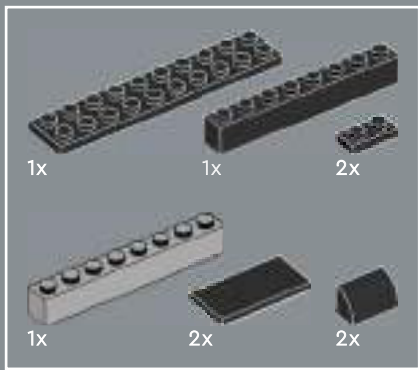

15

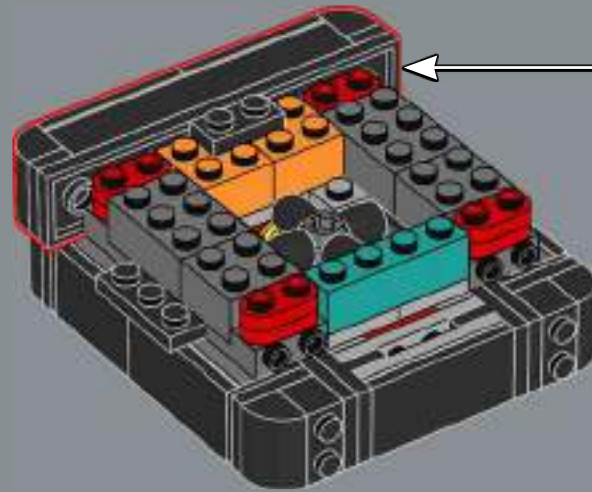



16

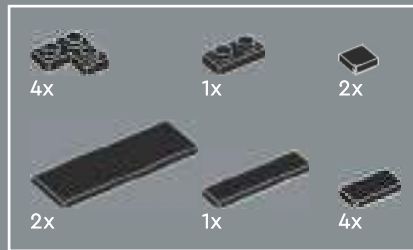
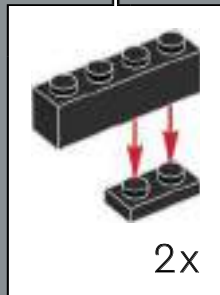
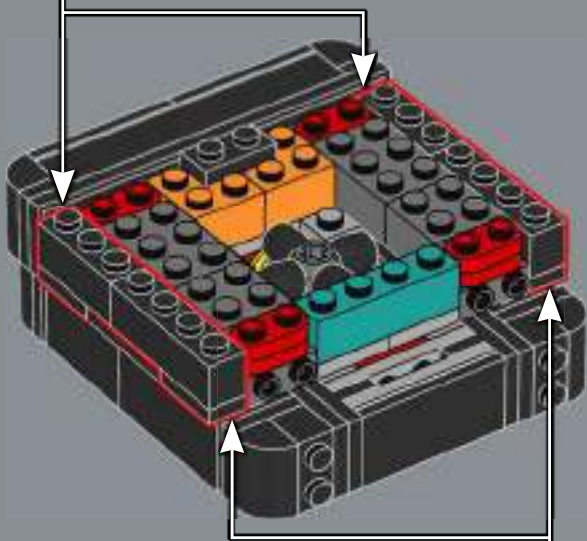
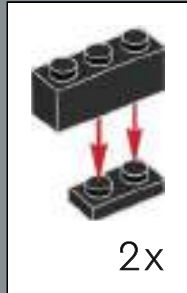

17

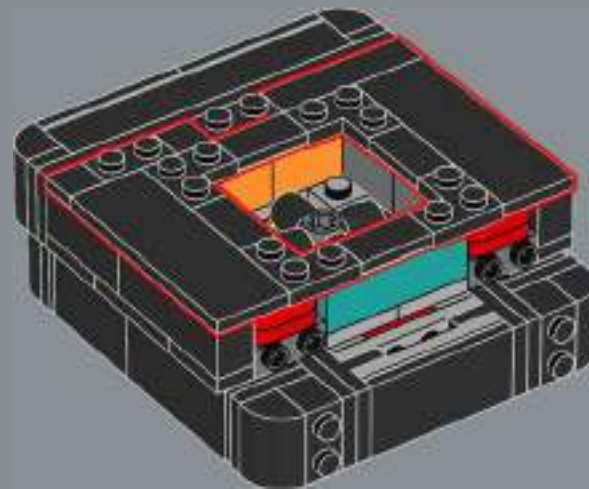

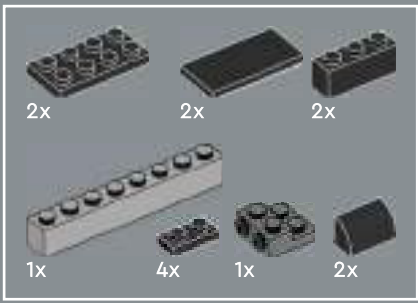

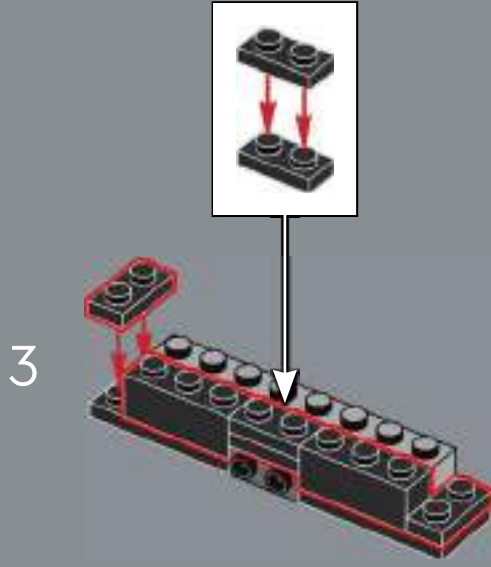
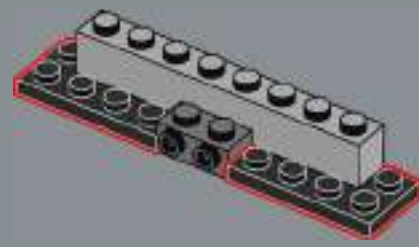
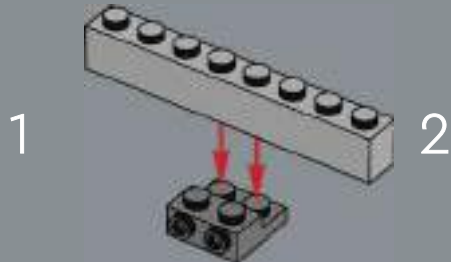

18

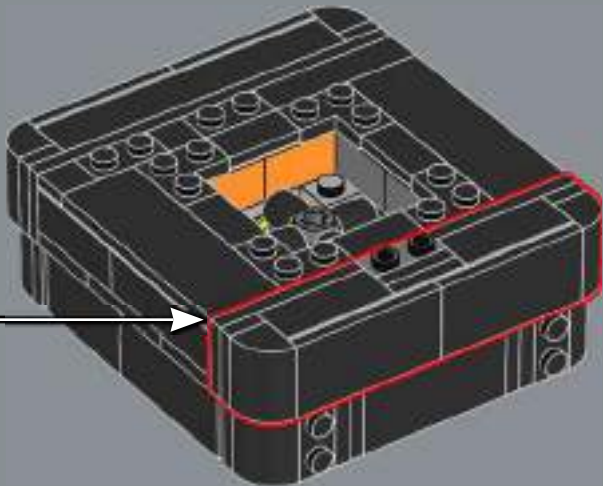

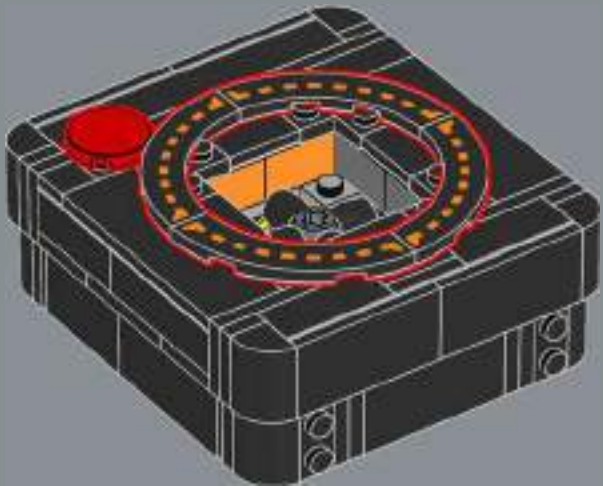

19



 The ATARI® Video Computer System joystick is so iconic that its shape and bright red button is often used in graphical icons to represent gaming.



20

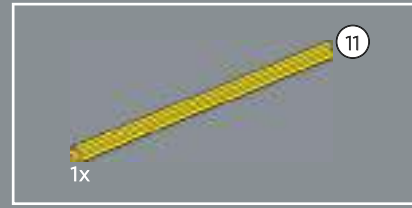

21

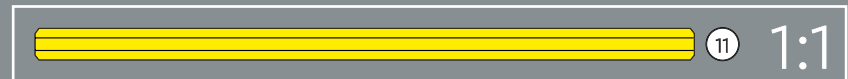



22



23





24



25

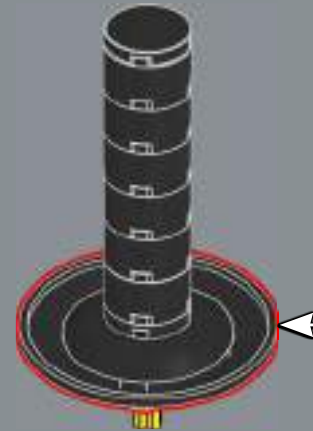
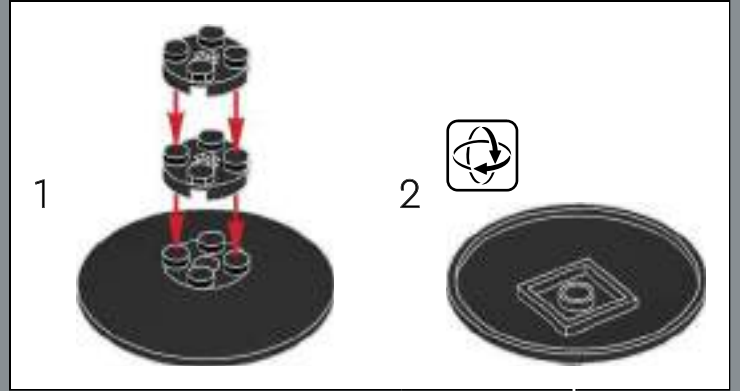

26

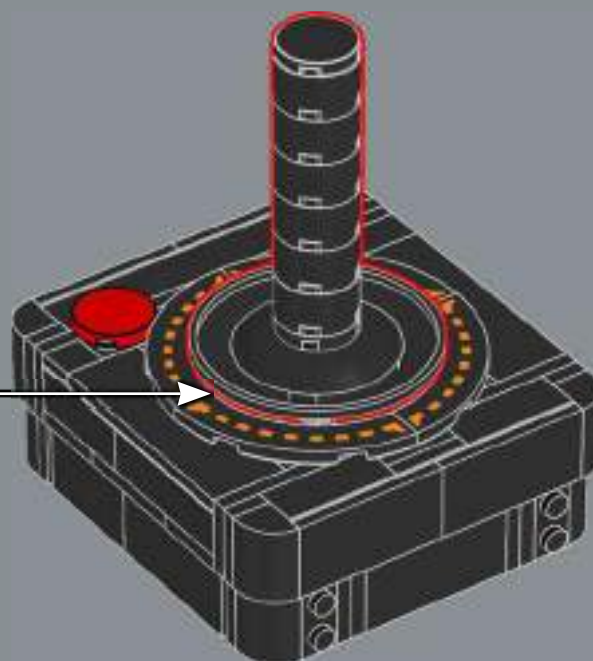

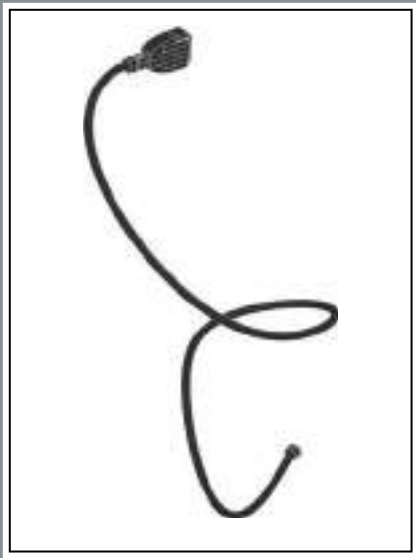

27



28

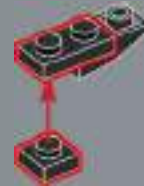

29





30



31

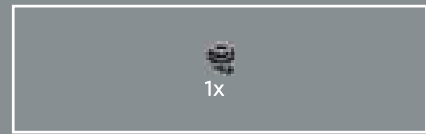
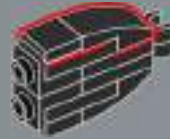

32

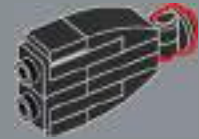



2x

33



2x

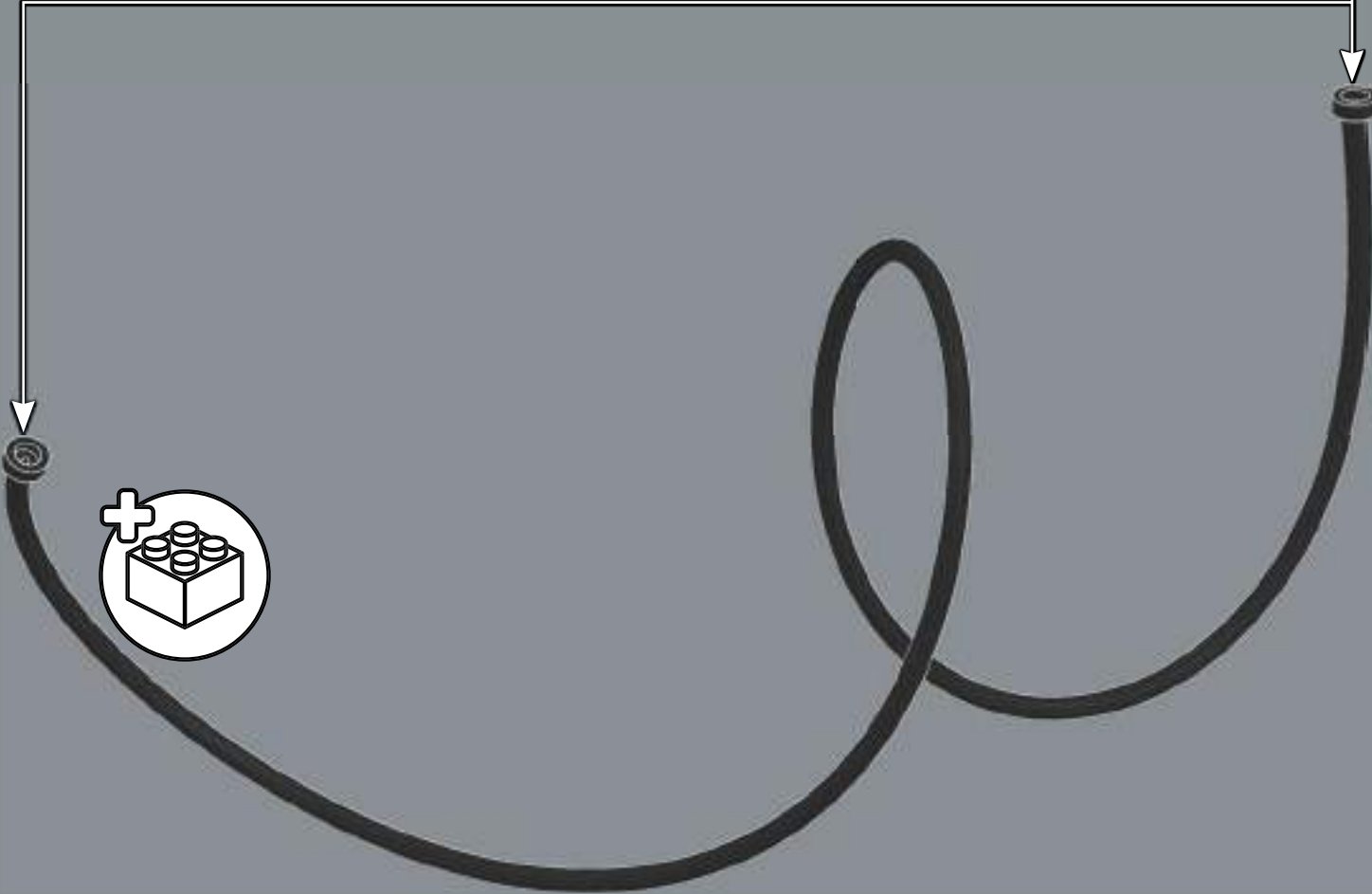

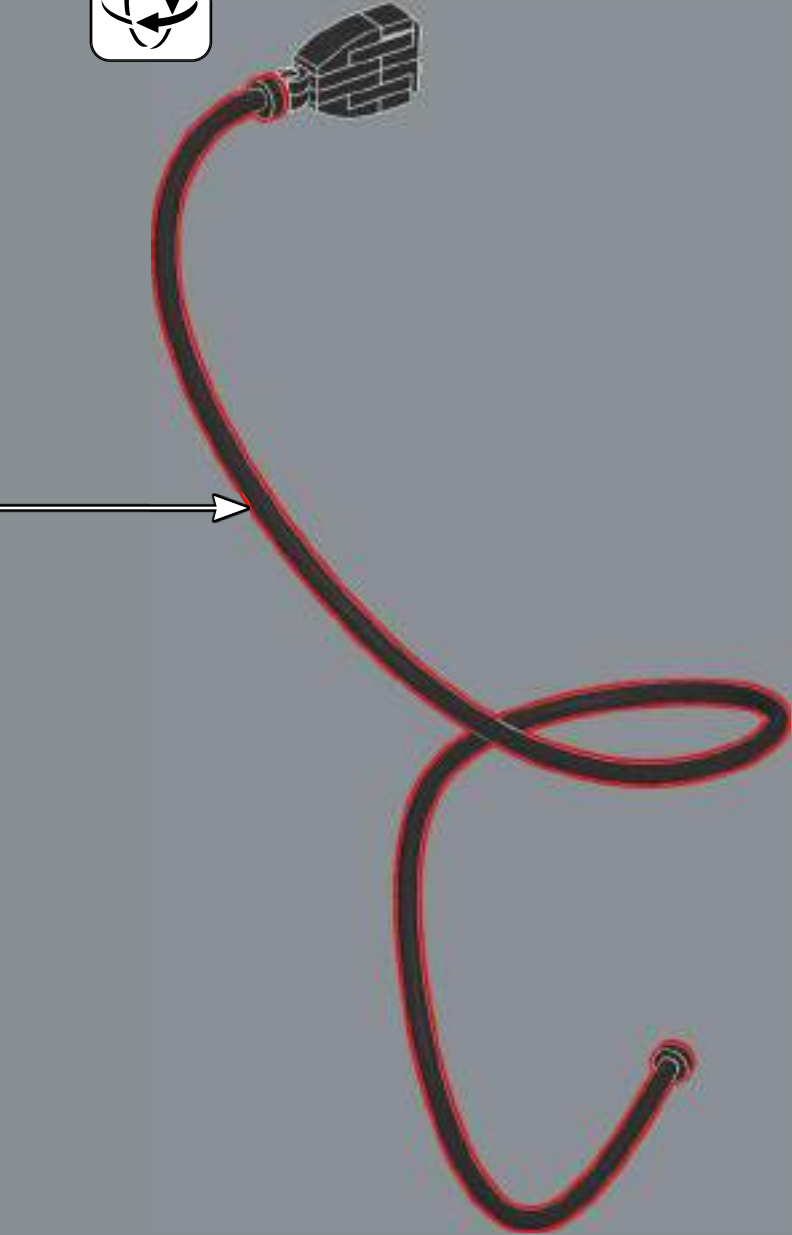

34

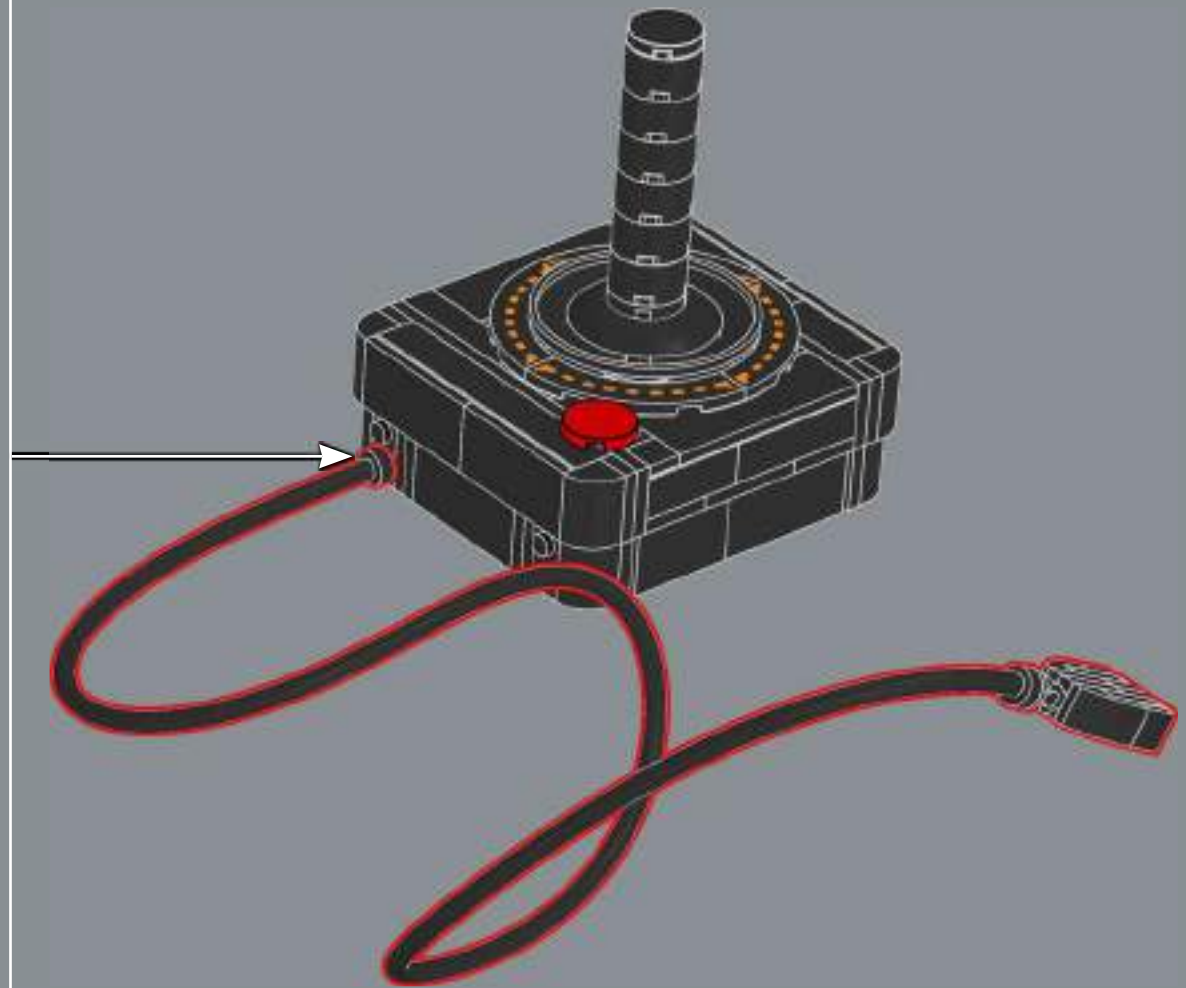

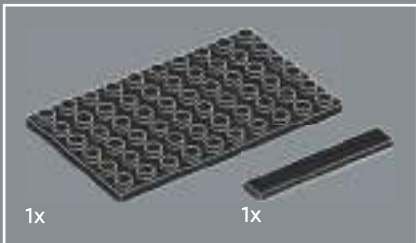

1

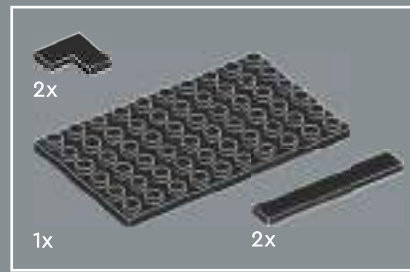
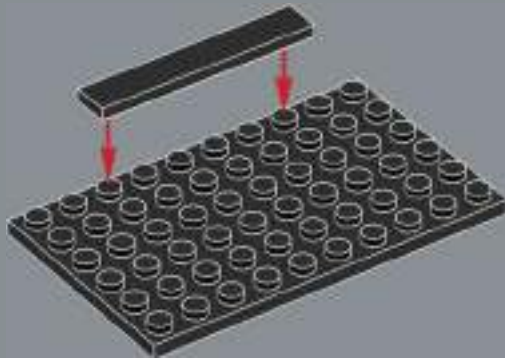

2

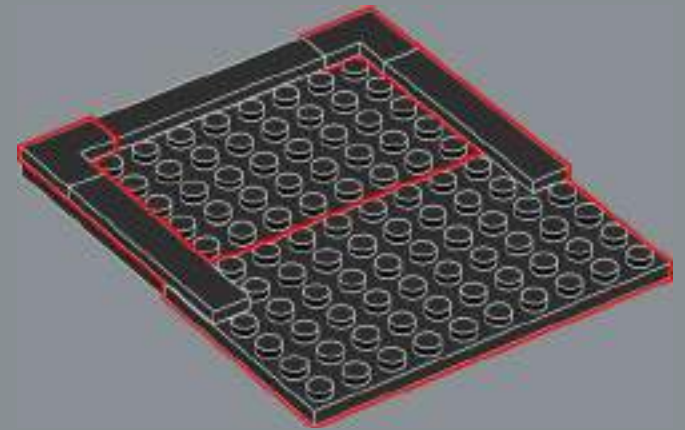

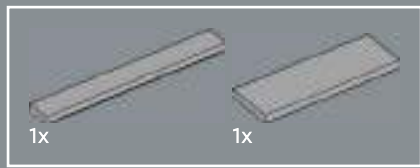

3

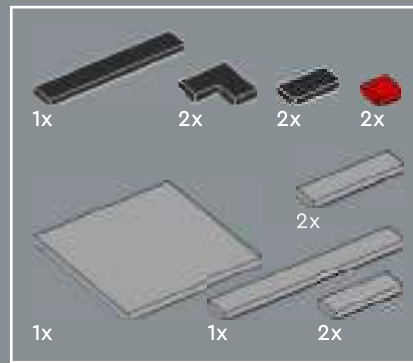
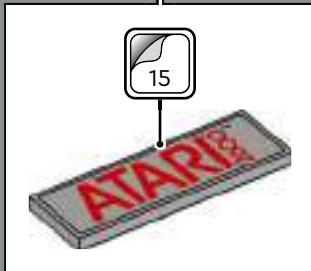
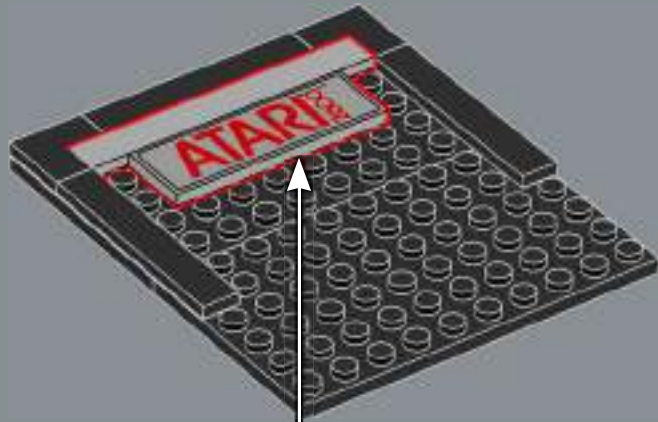

4

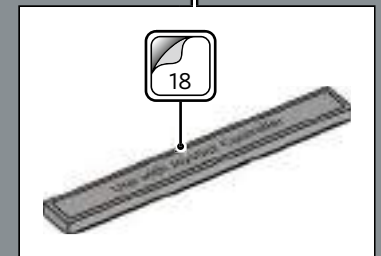

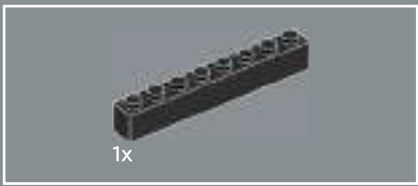

5



6

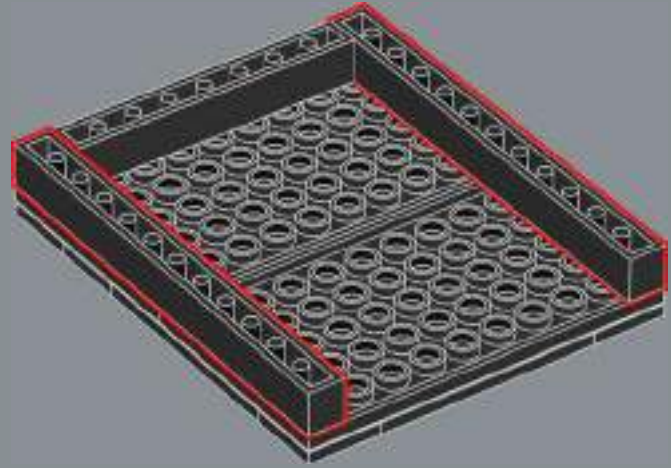



1x

2x

7

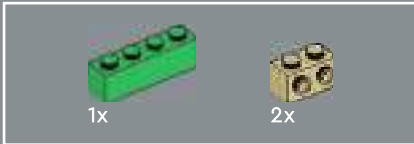
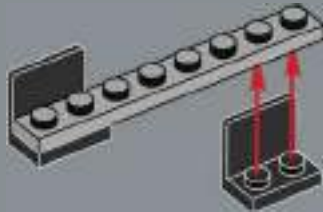

1x

2x

8

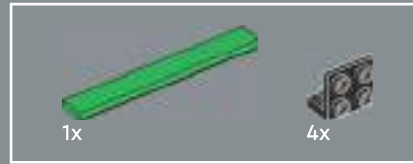
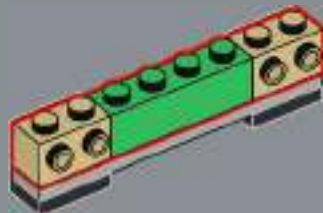

1x

4x

9

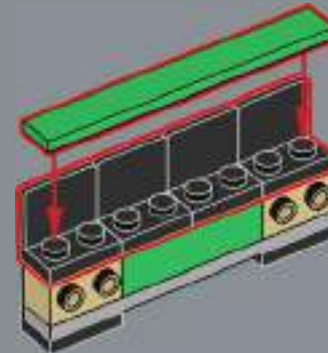

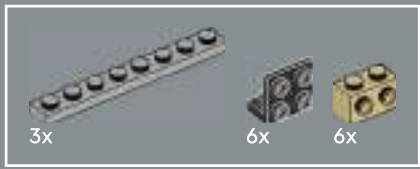

10

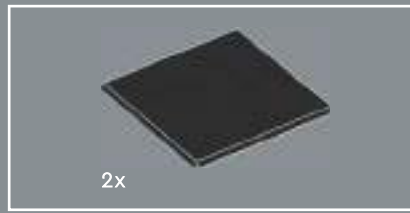
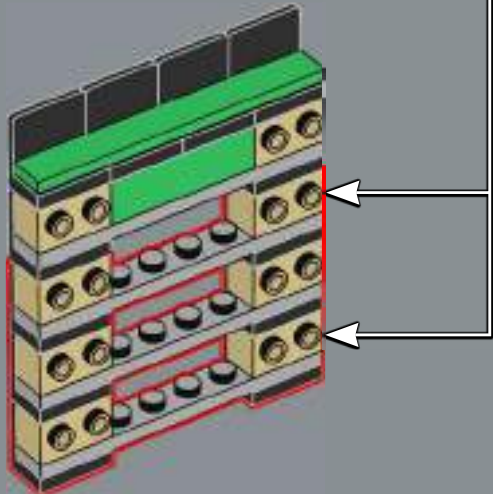
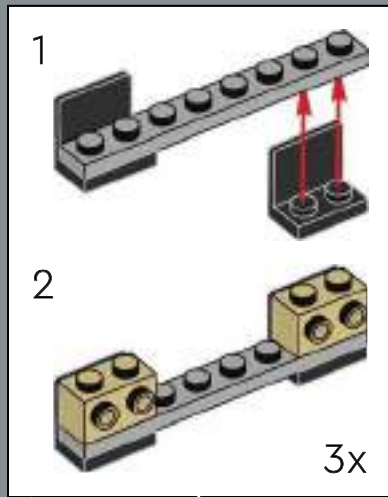

11

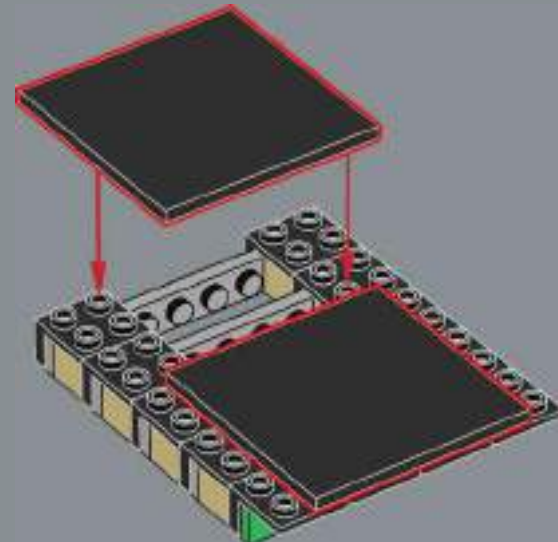

12

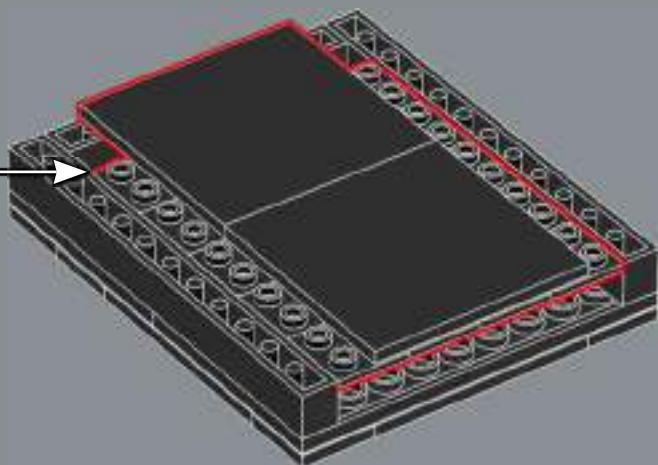

13

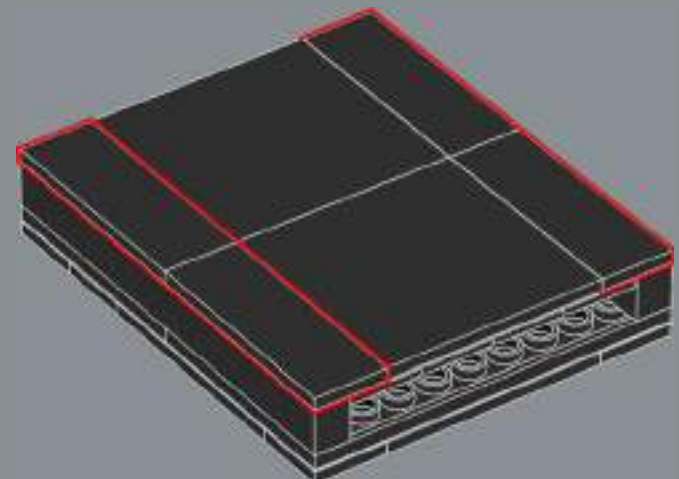

14



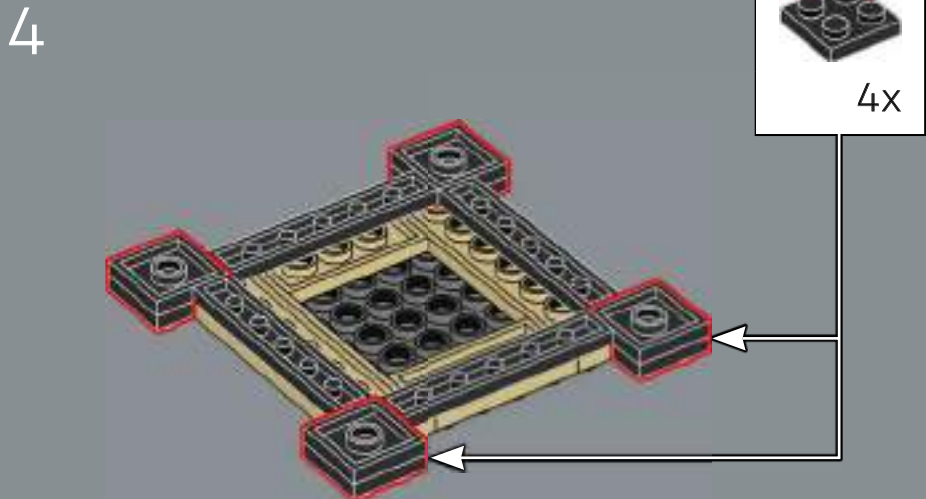
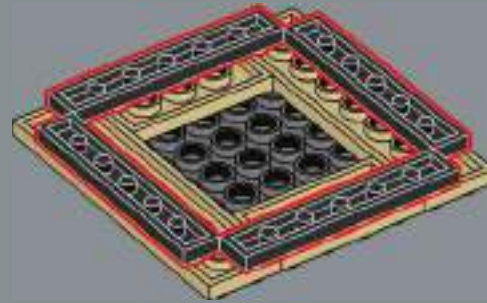
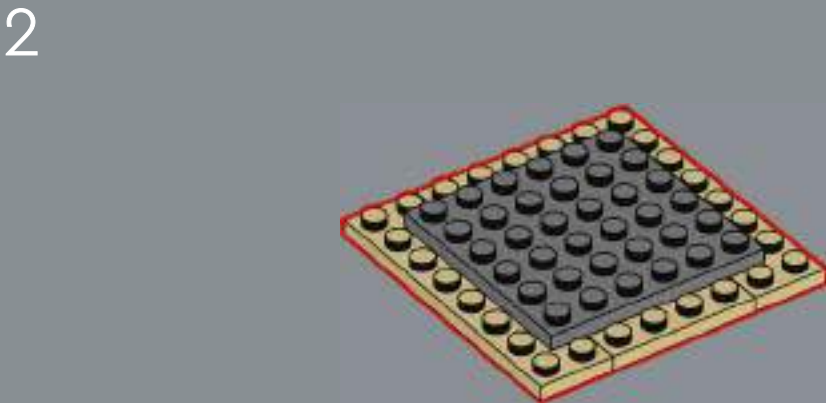
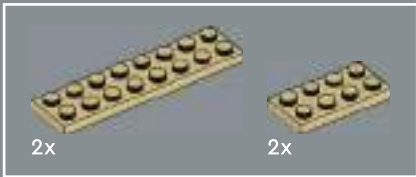



5

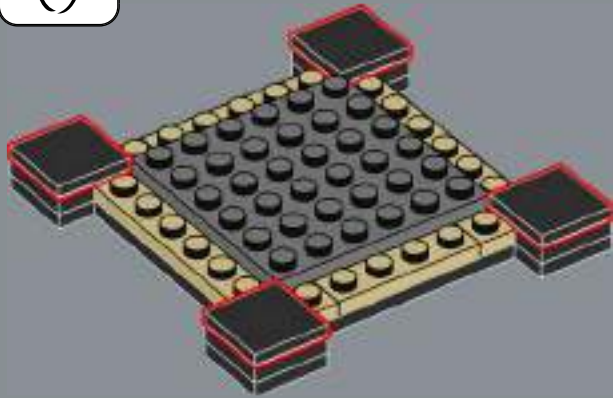

6

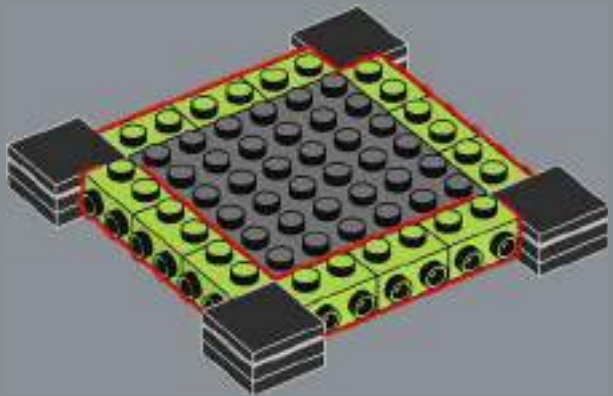

7

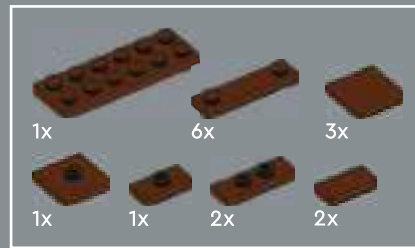
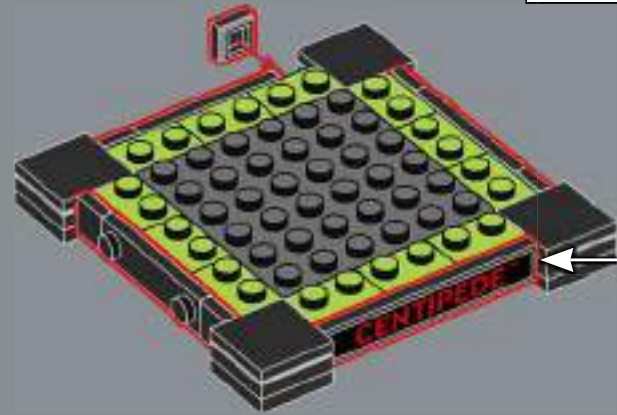
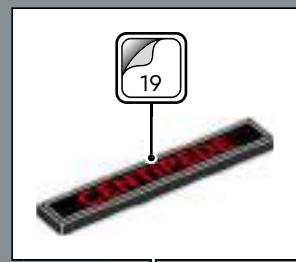

8

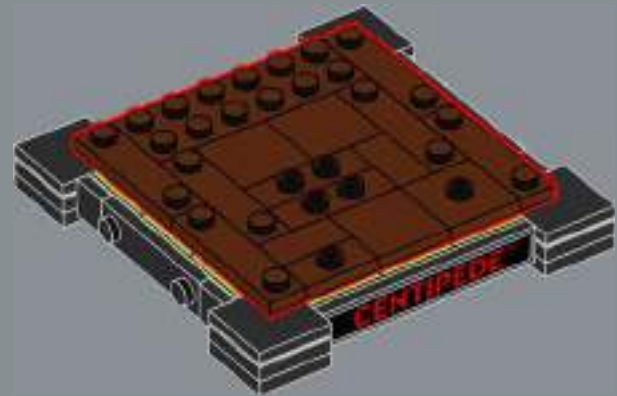

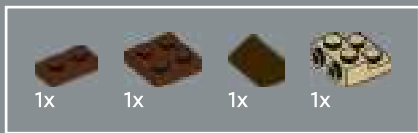

9

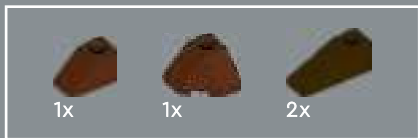
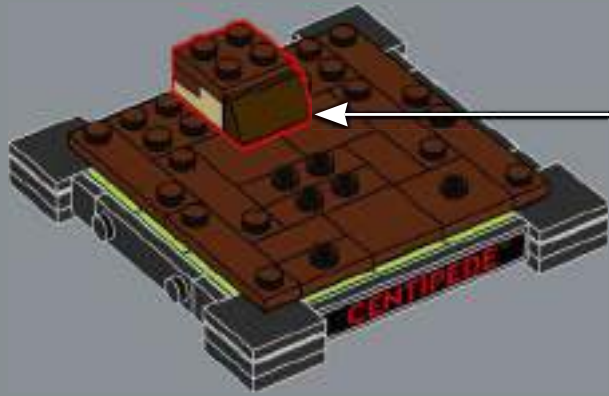
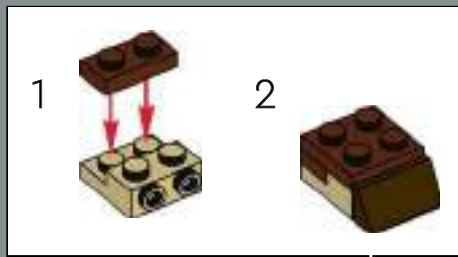

10

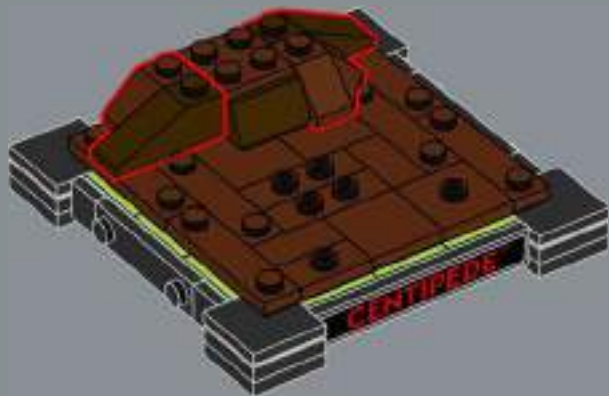

11

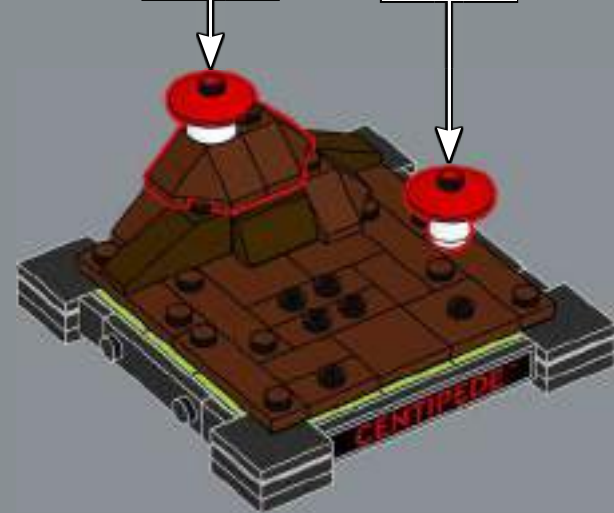
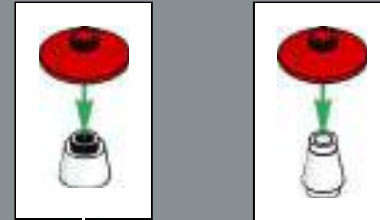

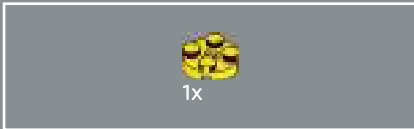

12



13

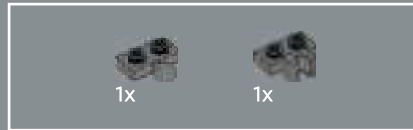

14

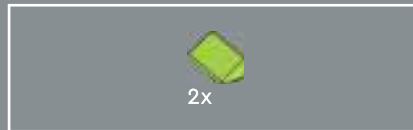

15





4x

16



4x



2x



2x



2x



8x



4x

17

1



2



3



4



5



2x

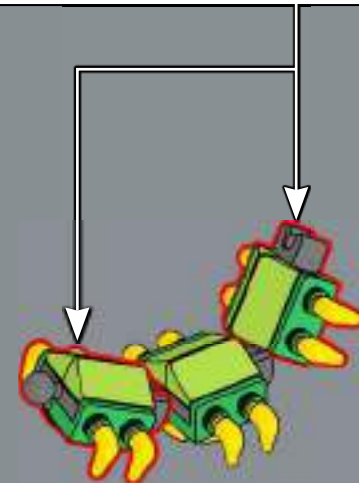

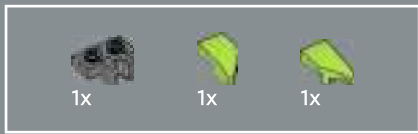

18

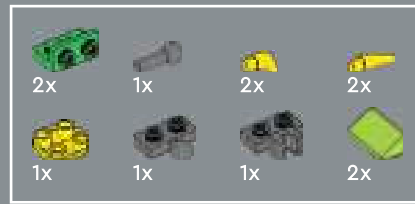
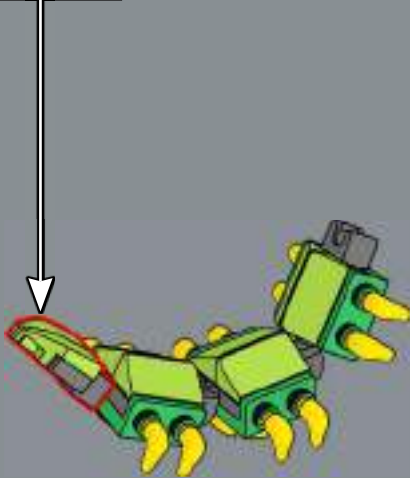
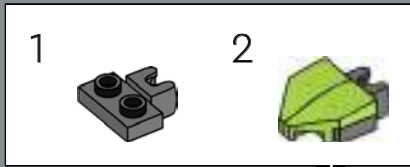

19

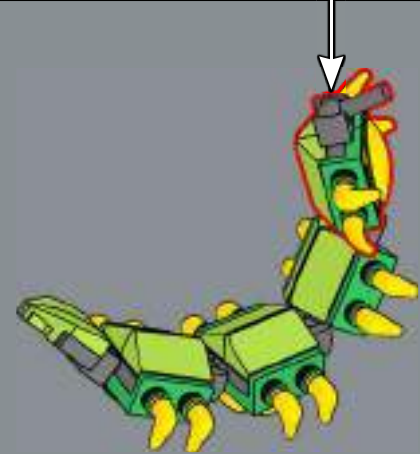
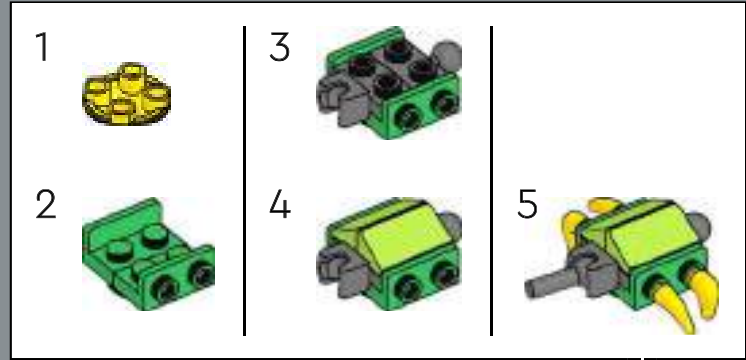

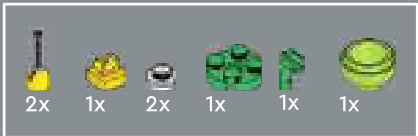

20

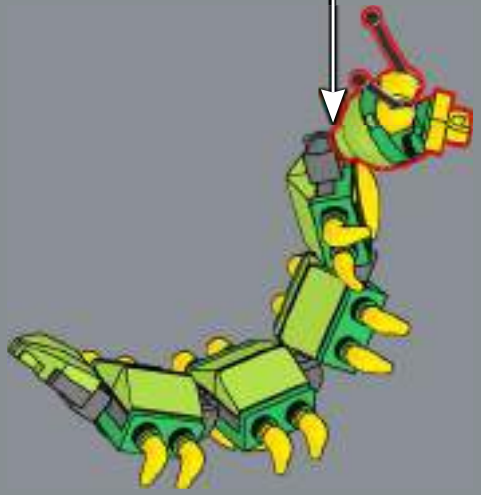
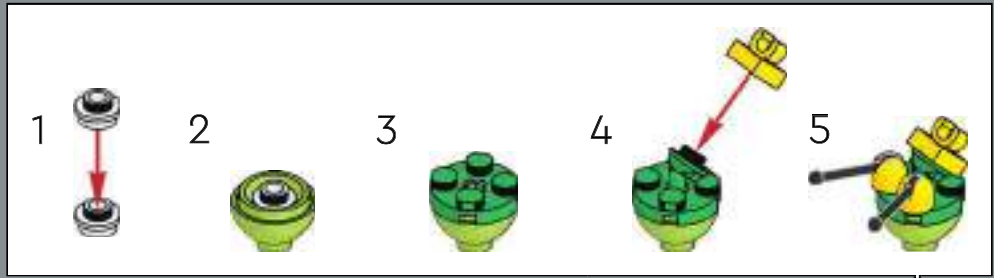

21



22

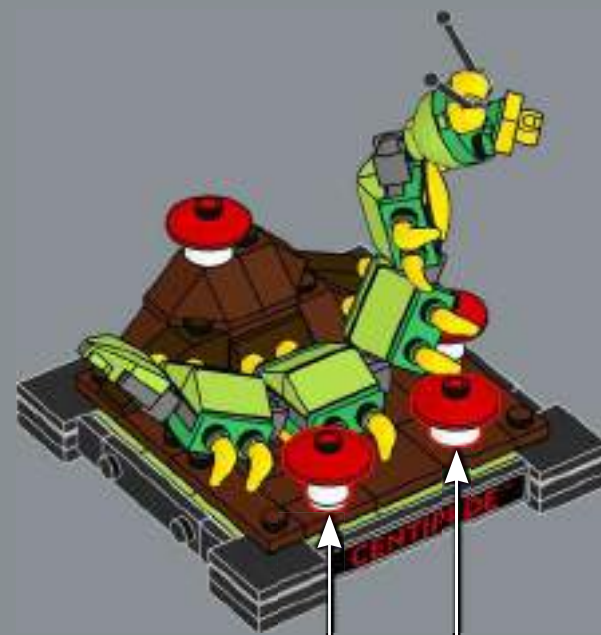
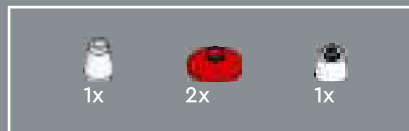



The ATARI® Video Computer System
debuted on 11 September 1977,
for a price of \$189.95 US
(over \$800 in today's money!)

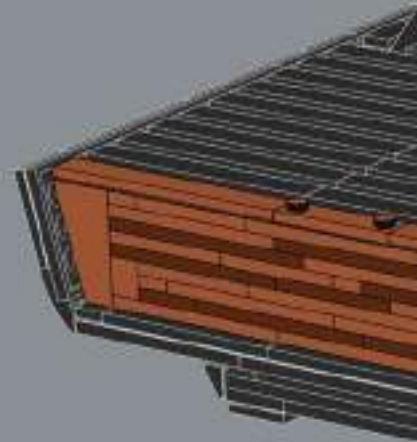
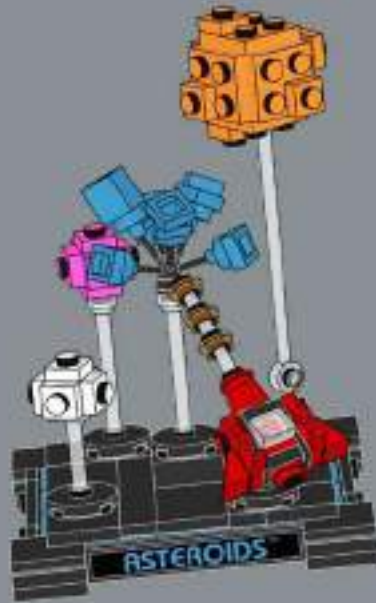

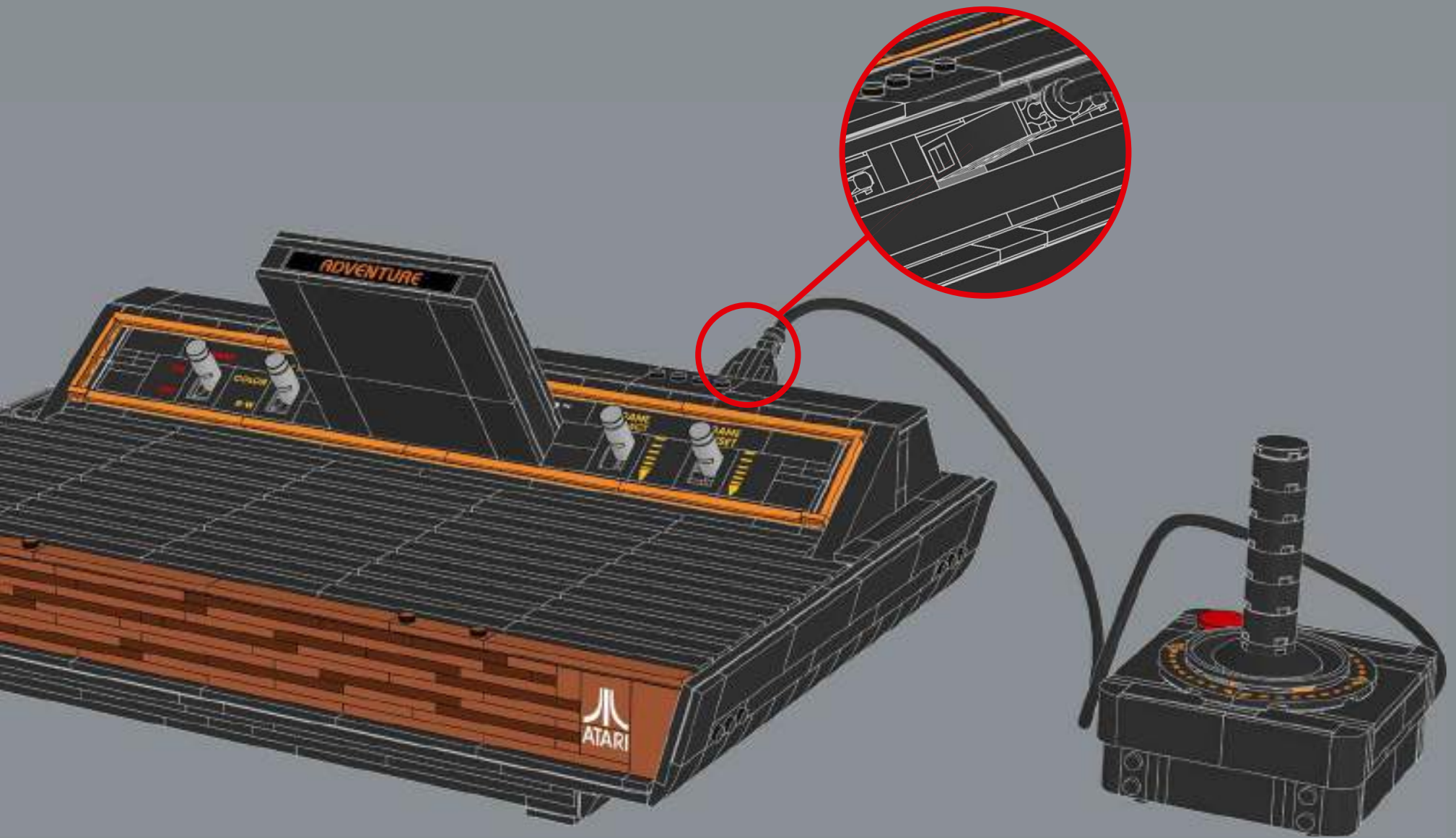

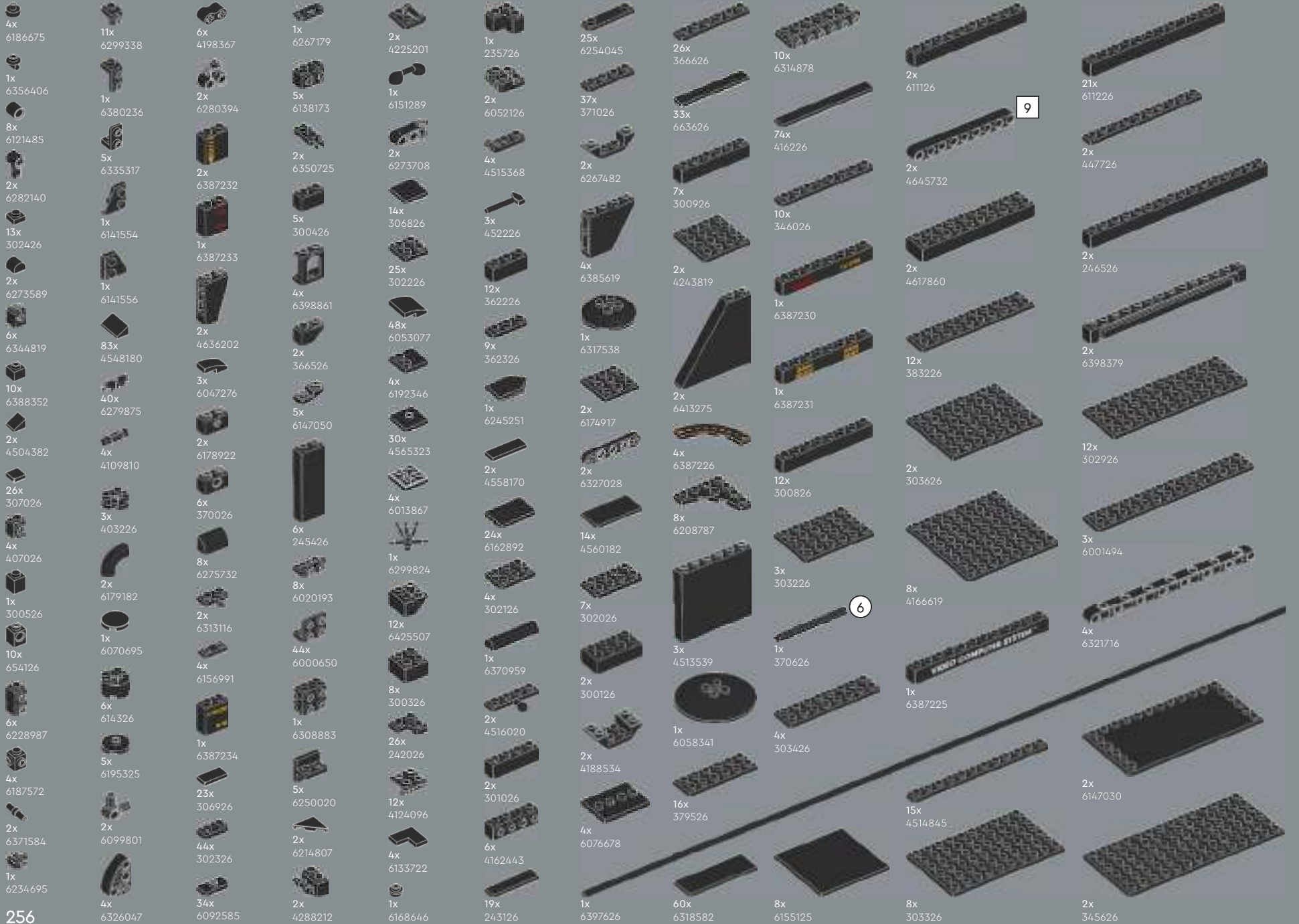

4x 6186675
1x 6356406
8x 6121485
2x 6282140
13x 302426
2x 6273589
6x 6344819
10x 6388352
2x 4504382
26x 307026
4x 407026
1x 300526
10x 654126
6x 6228987
4x 6187572
2x 6371584
1x 6234695

11x 6299338
1x 6380236
5x 6335317
1x 6141554
1x 6141556
83x 4548180
40x 6279875
4x 4109810
3x 403226
4x 407026
2x 6179182
1x 6070695
6x 614326
5x 6195325
2x 6099801
4x 6326047

6x 4198367
2x 6280394
2x 6387232
1x 6387233
2x 4636202
3x 6047276
2x 6178922
6x 370026
8x 6275732
2x 6313116
4x 6156991
1x 6387234
23x 306926
44x 302326
34x 6092585

1x 6267179
5x 6138173
2x 6350725
5x 300426
4x 6398861
2x 366526
5x 6147050
6x 245426
8x 6020193
44x 6000650
1x 6308883
5x 6250020
2x 6214807
2x 4288212

2x 4225201
1x 6151289
2x 6273708
14x 306826
25x 302226
48x 6053077
4x 6192346
30x 4565323
4x 6013867
1x 6299824
12x 6425507
8x 300326
26x 242026
12x 4124096
4x 6133722
1x 6168646

1x 235726
2x 6052126
4x 4515368
3x 452226
12x 362226
9x 362326
1x 6245251
2x 4558170
24x 6162892
4x 302126
1x 6370959
2x 4516020
2x 301026
6x 4162443
19x 243126

25x 6254045
37x 371026
2x 6267482
4x 6385619
1x 6317538
2x 6174917
2x 6327028
14x 4560182
7x 302026
2x 300126
2x 4188534
4x 6076678
1x 6397626

26x 366626
33x 663626
7x 300926
2x 4243819
1x 6317538
2x 6174917
2x 6327028
8x 6208787
3x 4513539
1x 6058341
16x 379526
60x 6318582

10x 6314878
74x 416226
10x 346026
1x 6387230
1x 6387231
12x 300826
3x 303226
1x 370626
4x 303426
8x 6155125

2x 611126
2x 4645732
2x 4617860
12x 383226
2x 303626
8x 4166619
1x 6387225
15x 4514845
8x 303326

21x 611226
2x 447726
2x 246526
2x 6398379
12x 302926
3x 6001494
4x 6321716
2x 6147030
2x 345626

9

6

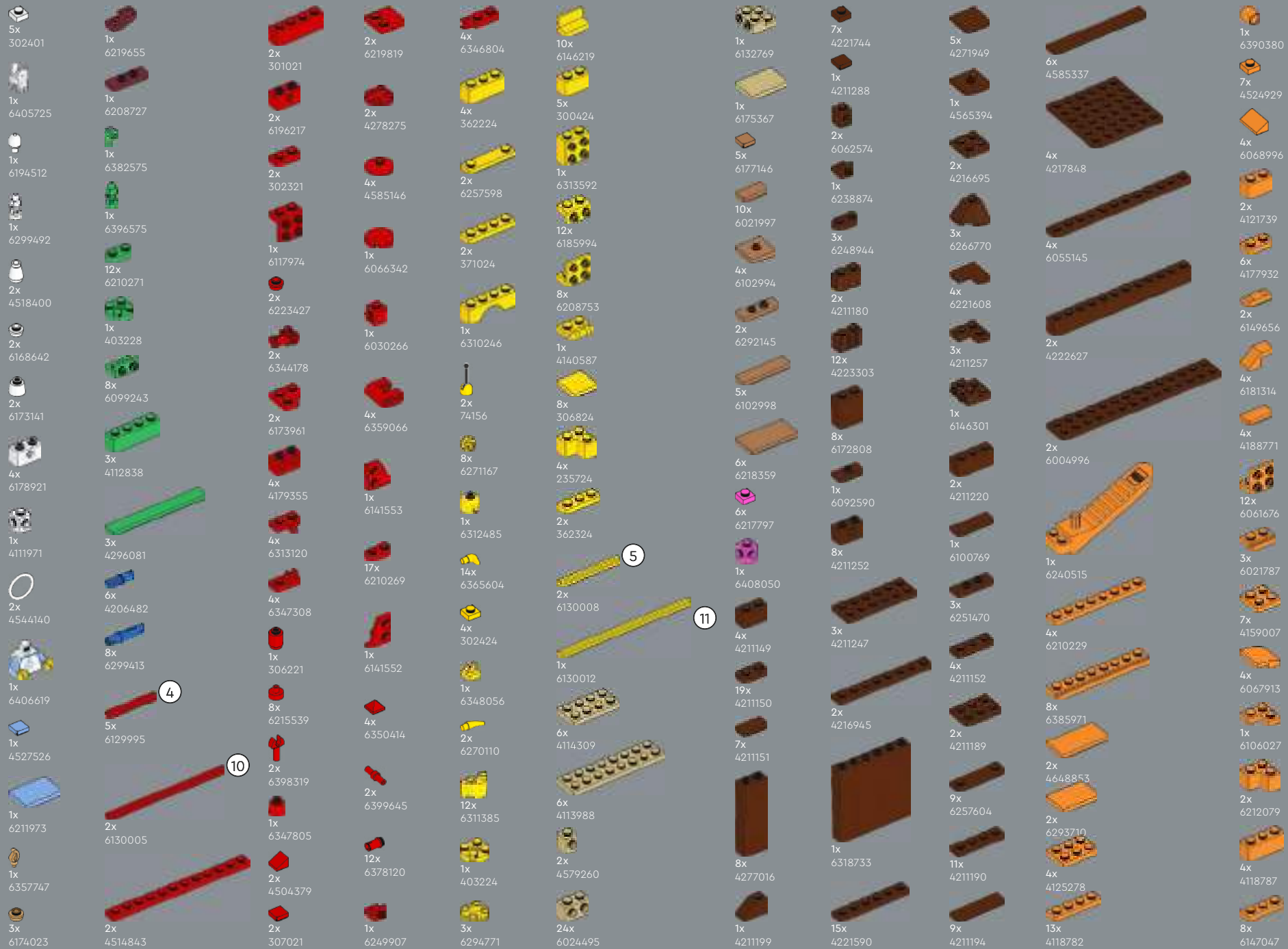



Customer Service
 Kundenservice
 Service Client
 Assistenza clienti
 Atención al cliente
 Serviço de Apoio ao Consumidor
 Ügyfélszolgálat
 Klientu apkalpošanas dienests
 Serviciul pentru client
 客户服务
 コンシューマーサービス
 고객 서비스
LEGO.com/service

3

9

15



FEEDBACK AND WIN



FEEDBACK AND WIN

Your feedback will help shape the future development of this product series.

Please visit:

FEEDBACK UND GEWINNEN

Dein Feedback trägt zur Weiterentwicklung dieser Produktreihe bei.

Geh auf:

COMMENTEZ ET GAGNEZ

Vos commentaires nous aideront à concevoir les futurs produits de cette gamme.

Rendez-vous sur :

COMENTA Y GANA

Tu opinión nos ayudará a dar forma al desarrollo de esta serie de productos en el futuro.

Visita:

反馈有奖

您的反馈将有助于我们在今后改进本系列产品。

请访问：

LEGO.com/productfeedback

By completing, you will automatically enter a drawing to win a LEGO® set.

Terms & Conditions apply.

Durch Ausfüllen nimmst du automatisch an der Verlosung eines LEGO® Preises teil.

Es gelten die Teilnahmebedingungen.

En envoyant vos commentaires, vous serez automatiquement inscrit(e) à un tirage au sort qui vous permettra de remporter un prix LEGO®.

Offre soumise à conditions.

Al contestar, participarás automáticamente en el sorteo y podrás ganar un set LEGO®.

Sujeto a Términos y Condiciones.

完成我们的反馈调查,即可自动进入抽奖环节,赢取乐高®套装。

适用《条款和条件》。

