

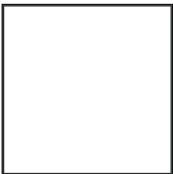

Booklet available in English on
Heft in deutscher Sprache erhältlich auf
Livret disponible en français sur
Libretto disponibile in italiano su
Folleto en español disponible en
如需中文版手册, 请访问





LEGO.com/sustainable-packaging



WELCOME

Get ready for a great night out with live music, entertainment and delicious food! Inspired by classic architecture and infused with our favourite music from the golden age of jazz, this hot new music venue is a fresh addition to the LEGO® Modular Building series. Whether this is your first modular set, or you have been building your LEGO street from the beginning, you are always invited to build to your own tune.

ANDERSON WARD GRUBB

Designer of the 10312 Jazz Club



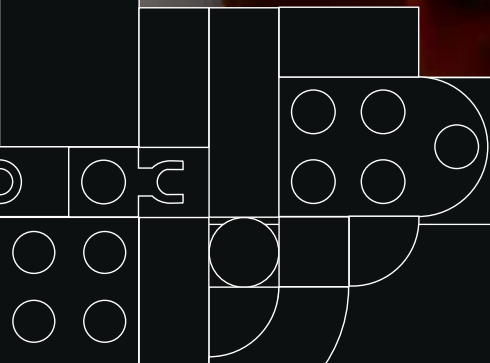

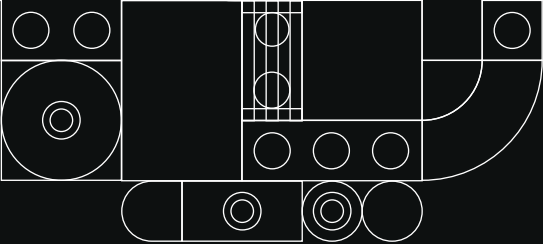

They say that in jazz, the notes that you don't play are just as important as the ones you do! Whether you're playing music notes or playing with LEGO® bricks, just play your own way!



LET THE MUSIC PLAY

Music can act as a virtual time machine that instantly takes you back to magical memories and moments in time or invites your imagination to travel to destinations you always dreamed of visiting. Play your favourite album on your vintage record player, jive into the LEGO® Icons Jazz Club and feel the thrilling atmosphere of this vibrant, mid-century magic and music melting pot full of creative, passionate performers, chefs and guests. Watch the show from the manager's office, grow produce for the kitchen in the rooftop greenhouse, feel the jitters in the dressing room, order a late-night snack, or enjoy a meal in the sidewalk café on a sizzling summer evening. No ticket or reservation required; your imagination grants you VIP access.



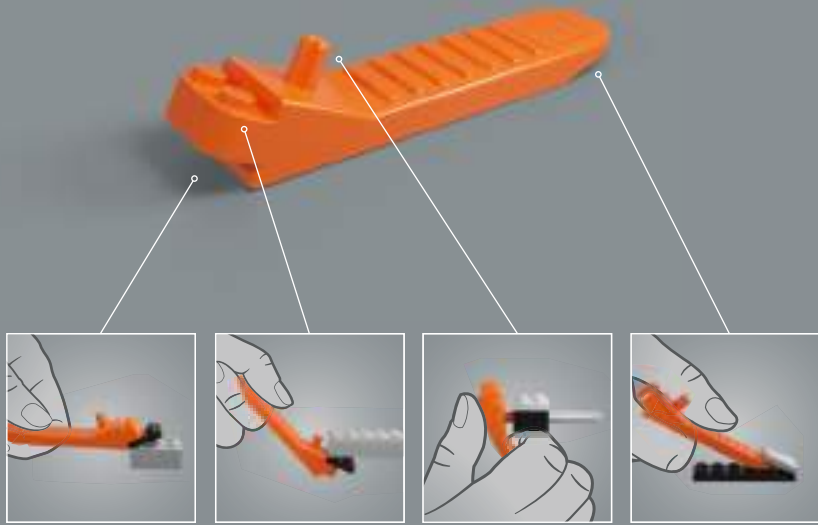
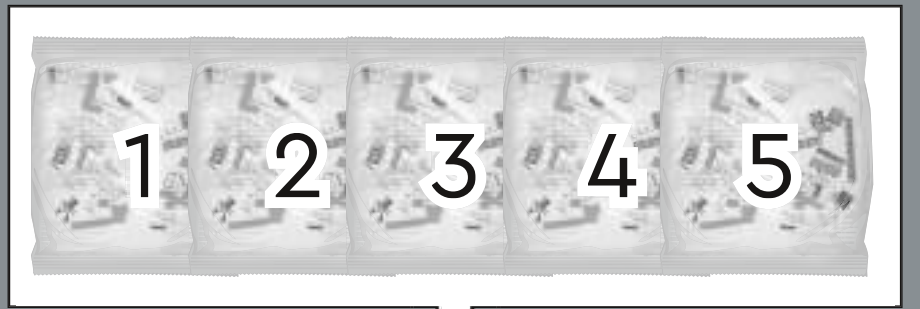

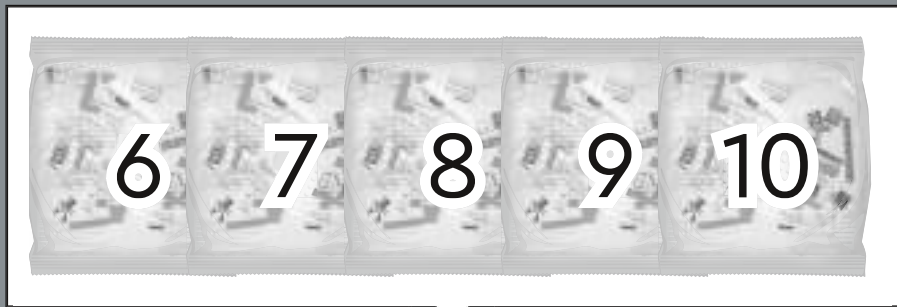

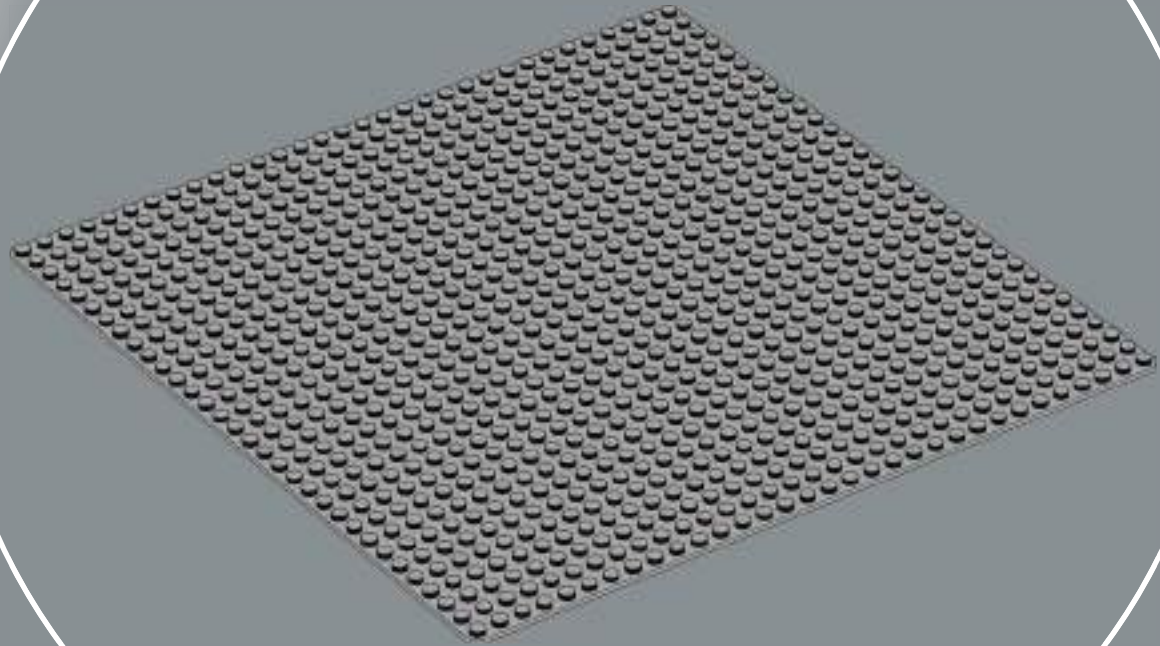
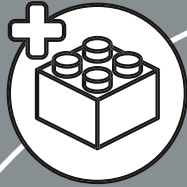



1

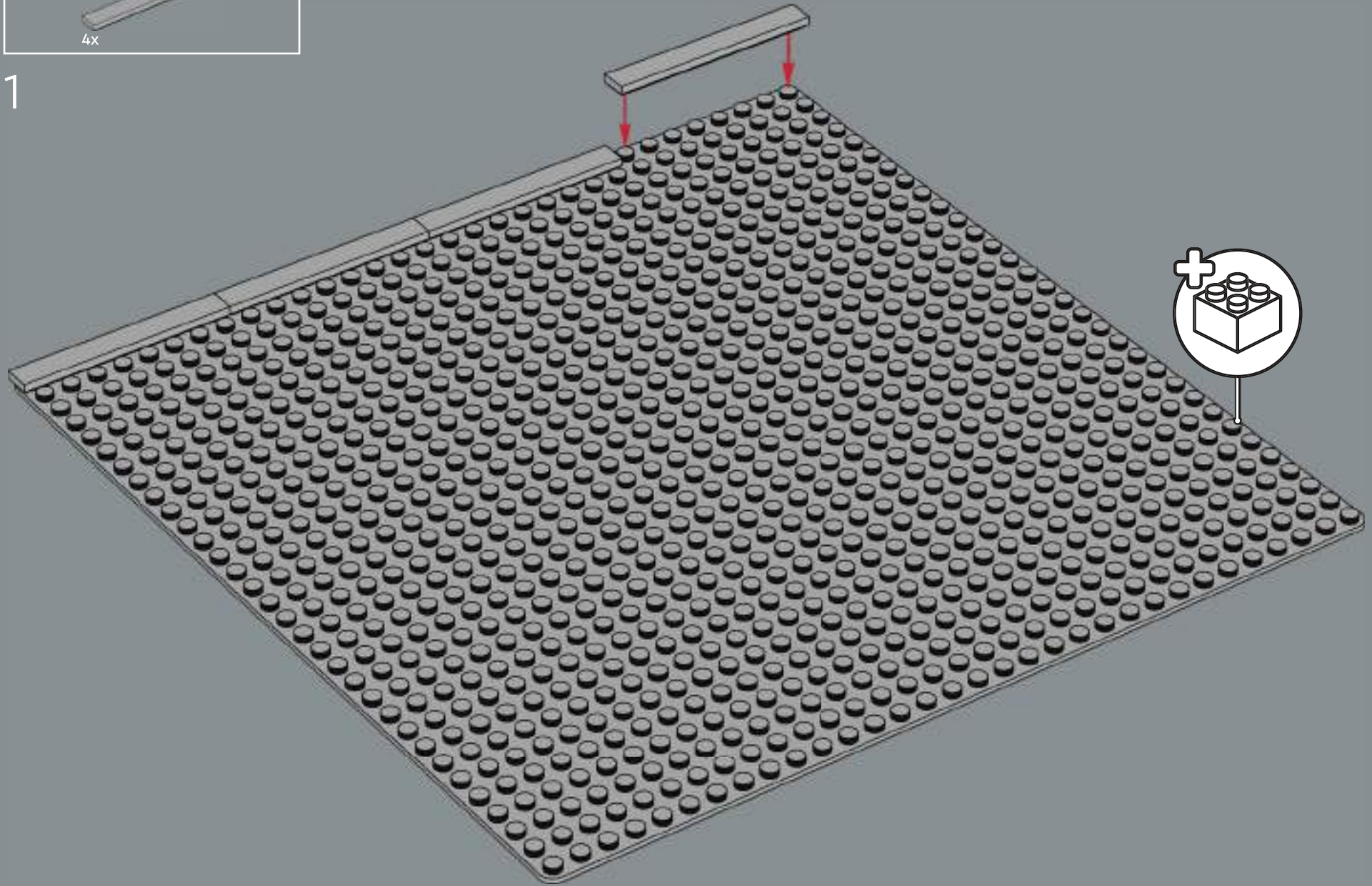

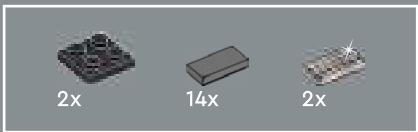

2

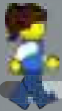
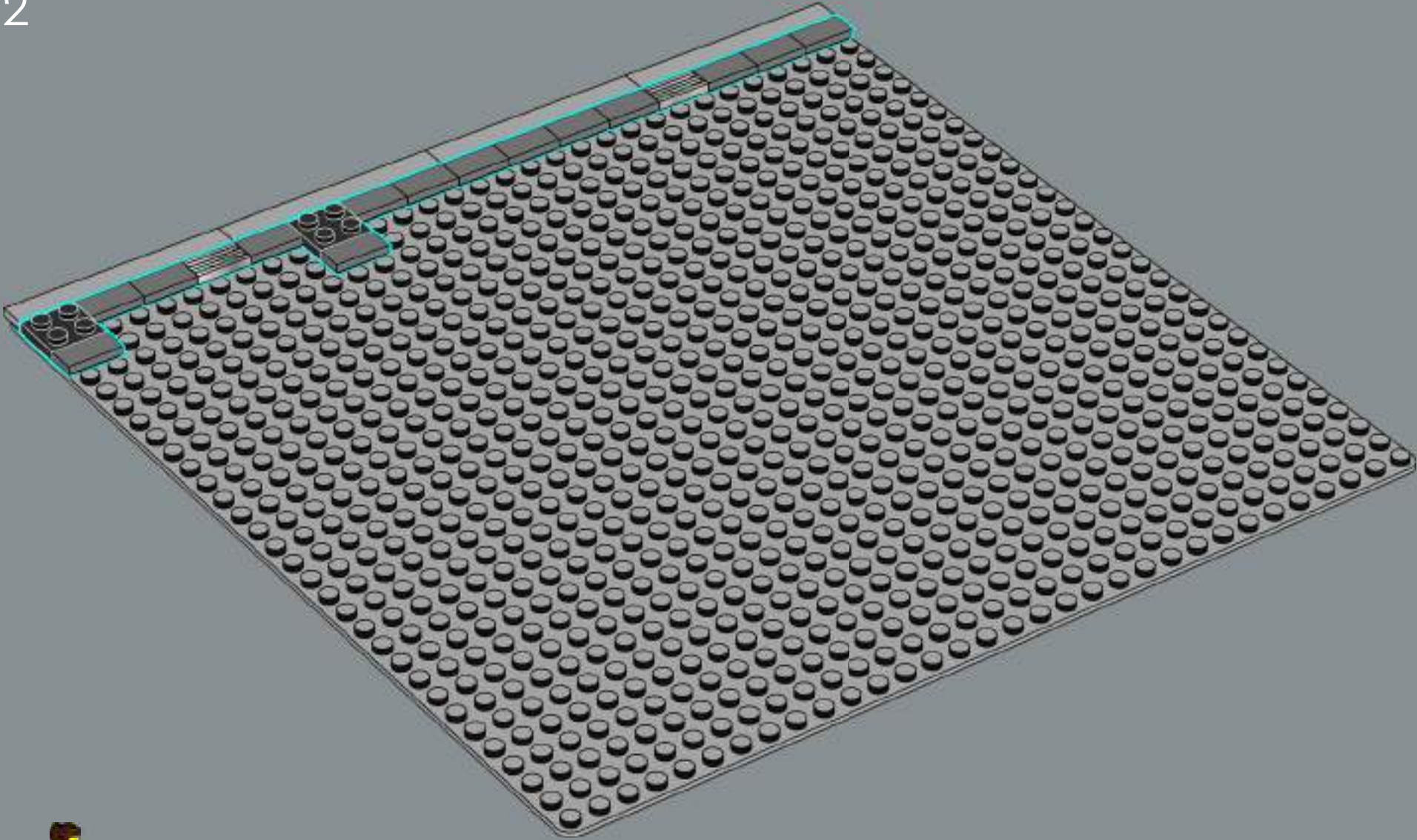

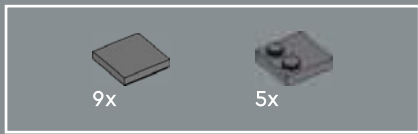

3

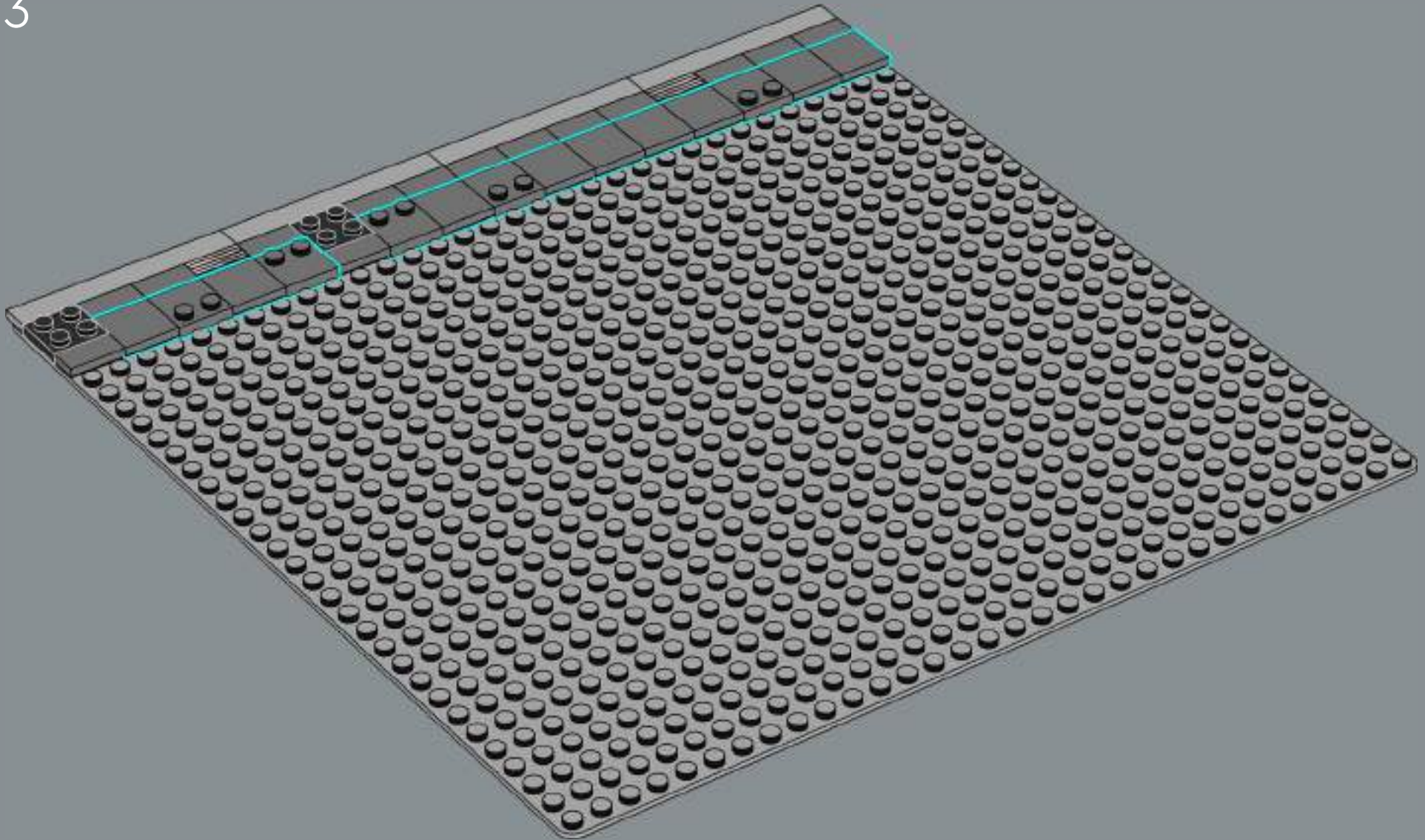

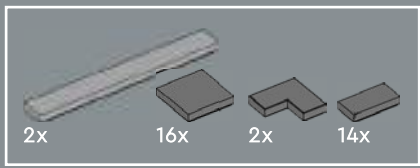

4

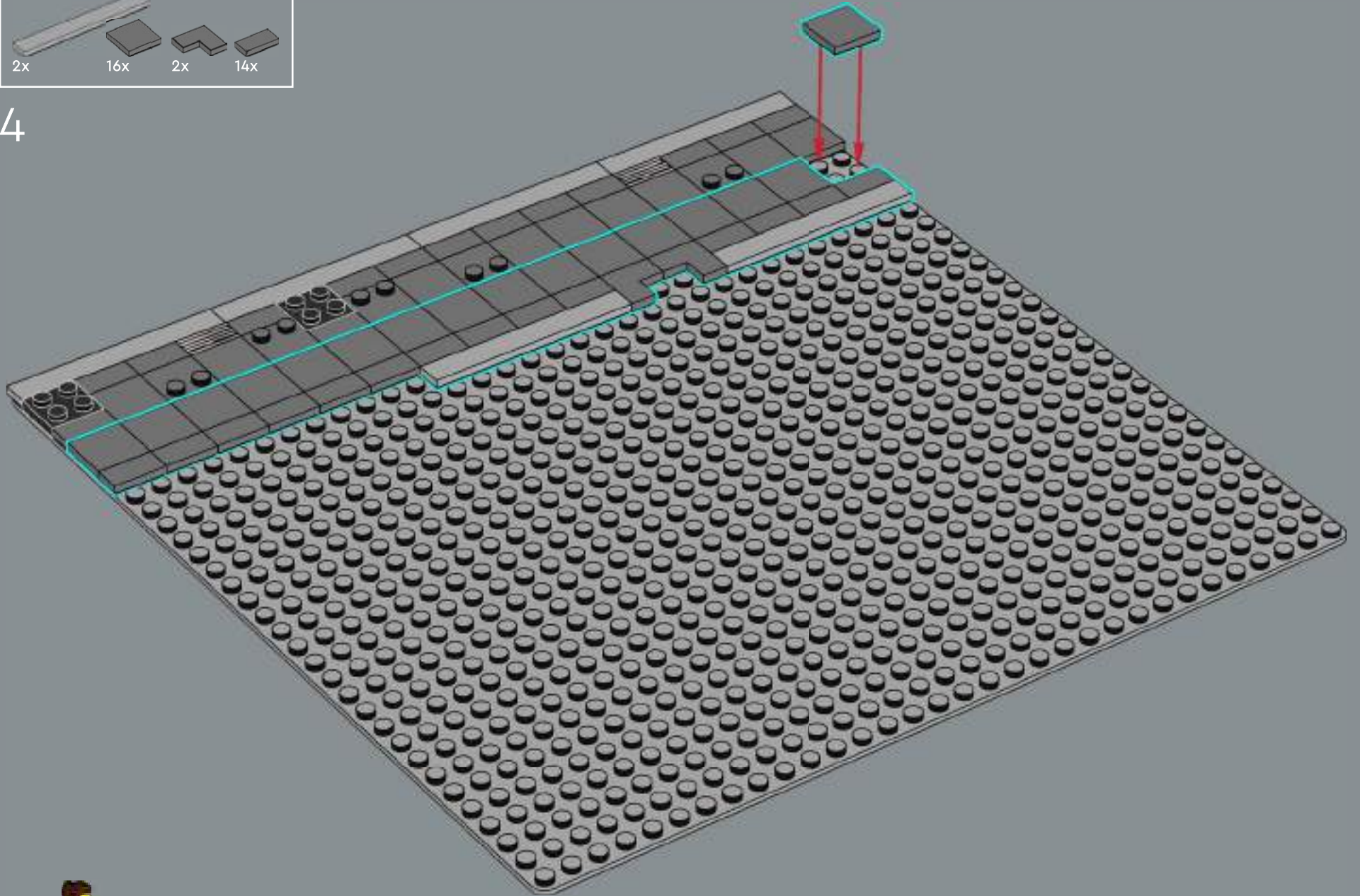

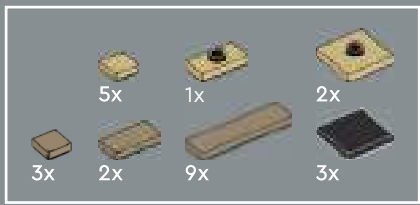

6

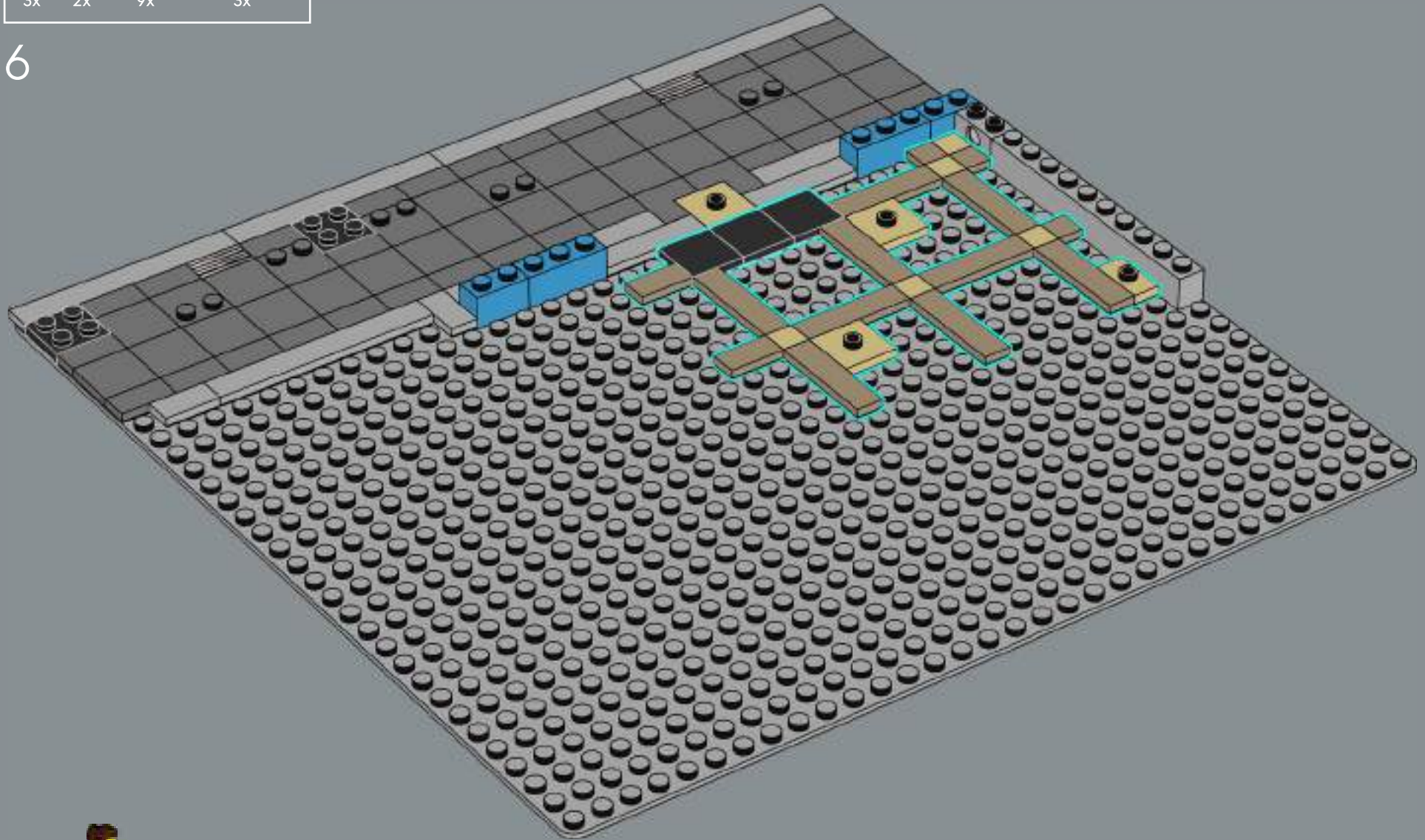

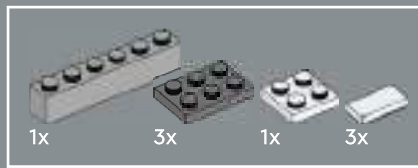

7

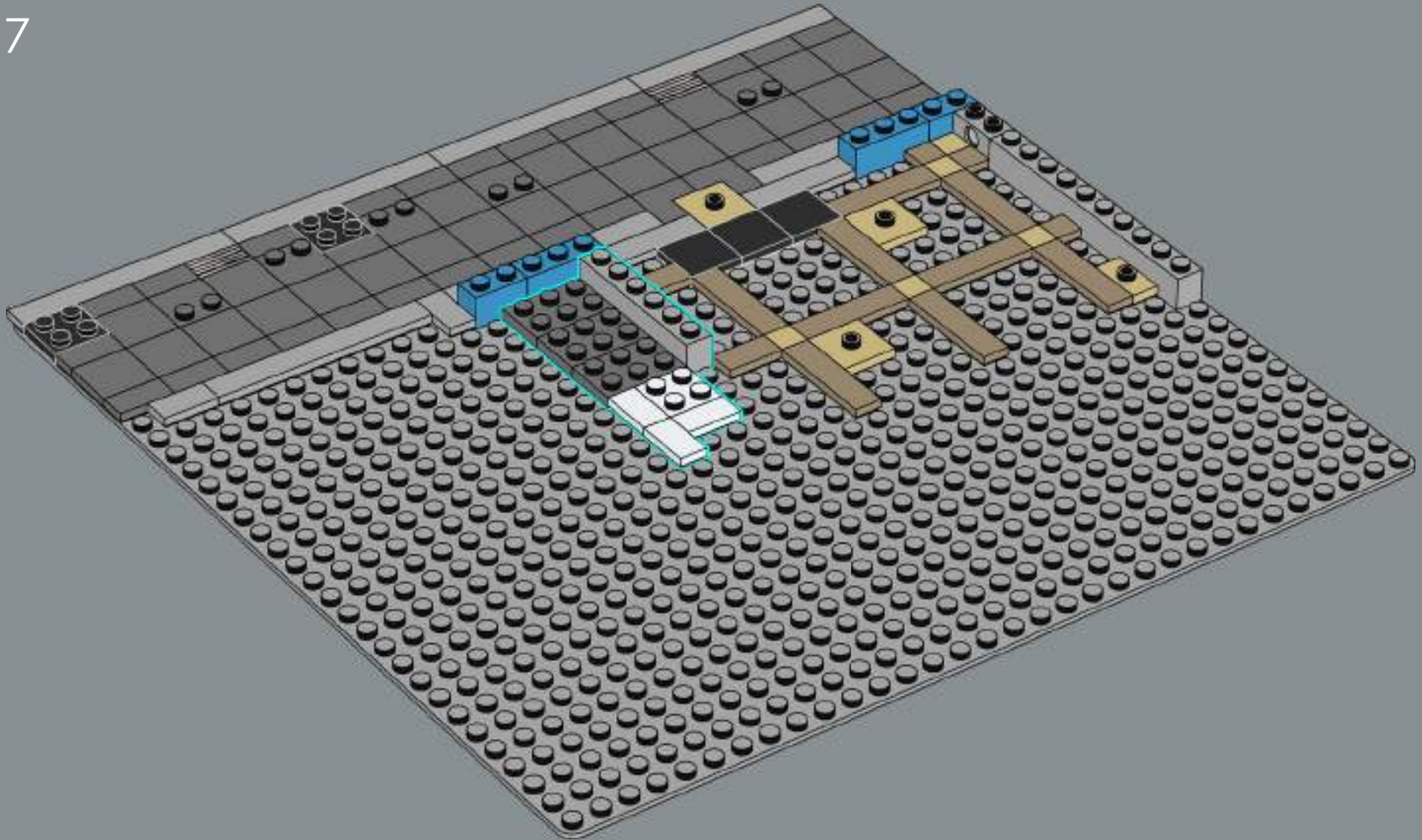

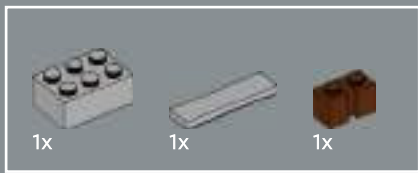

8

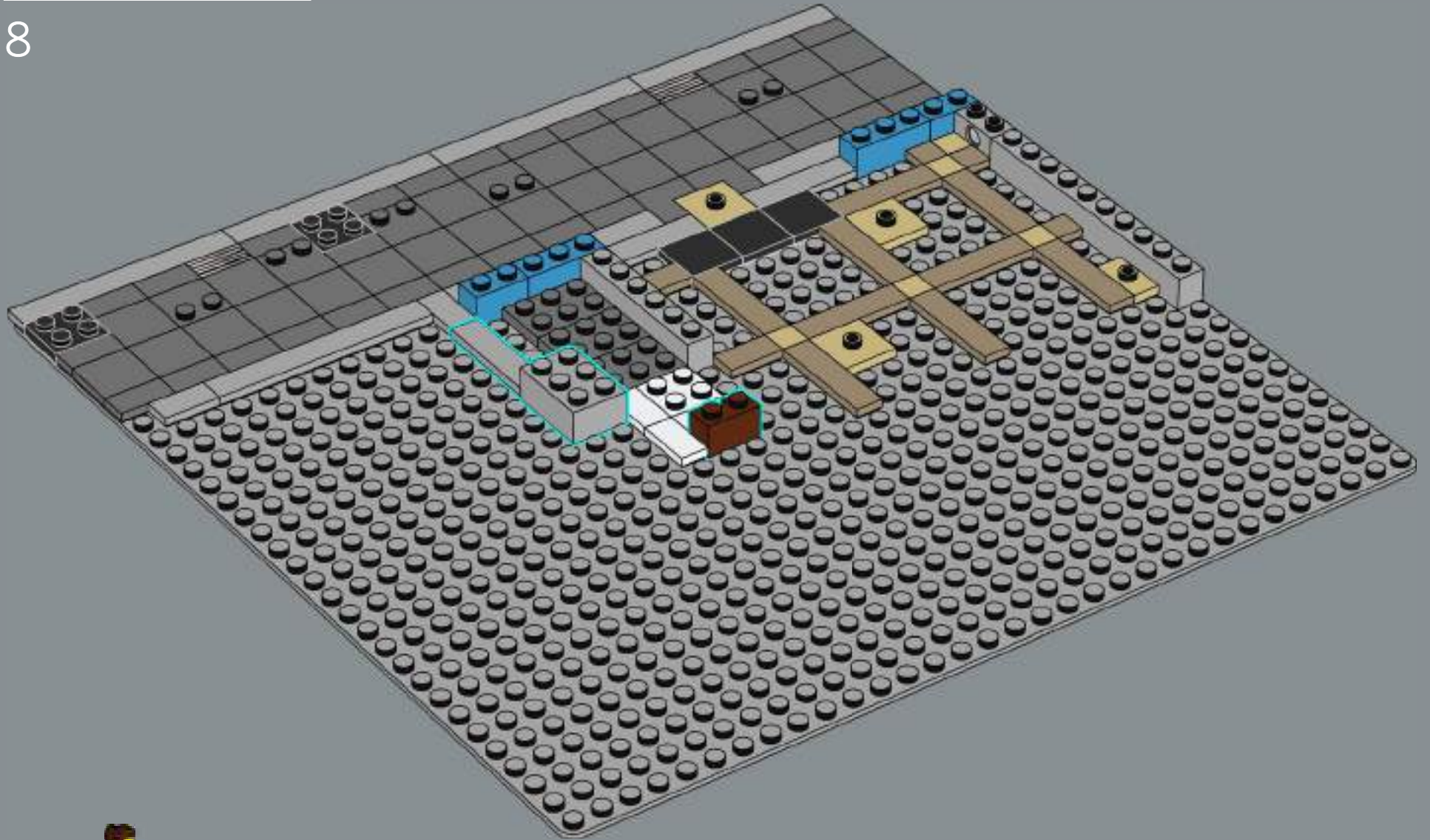

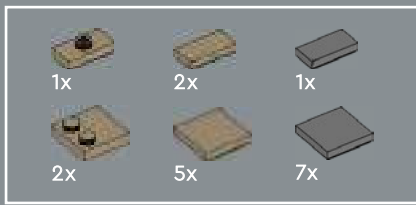

9

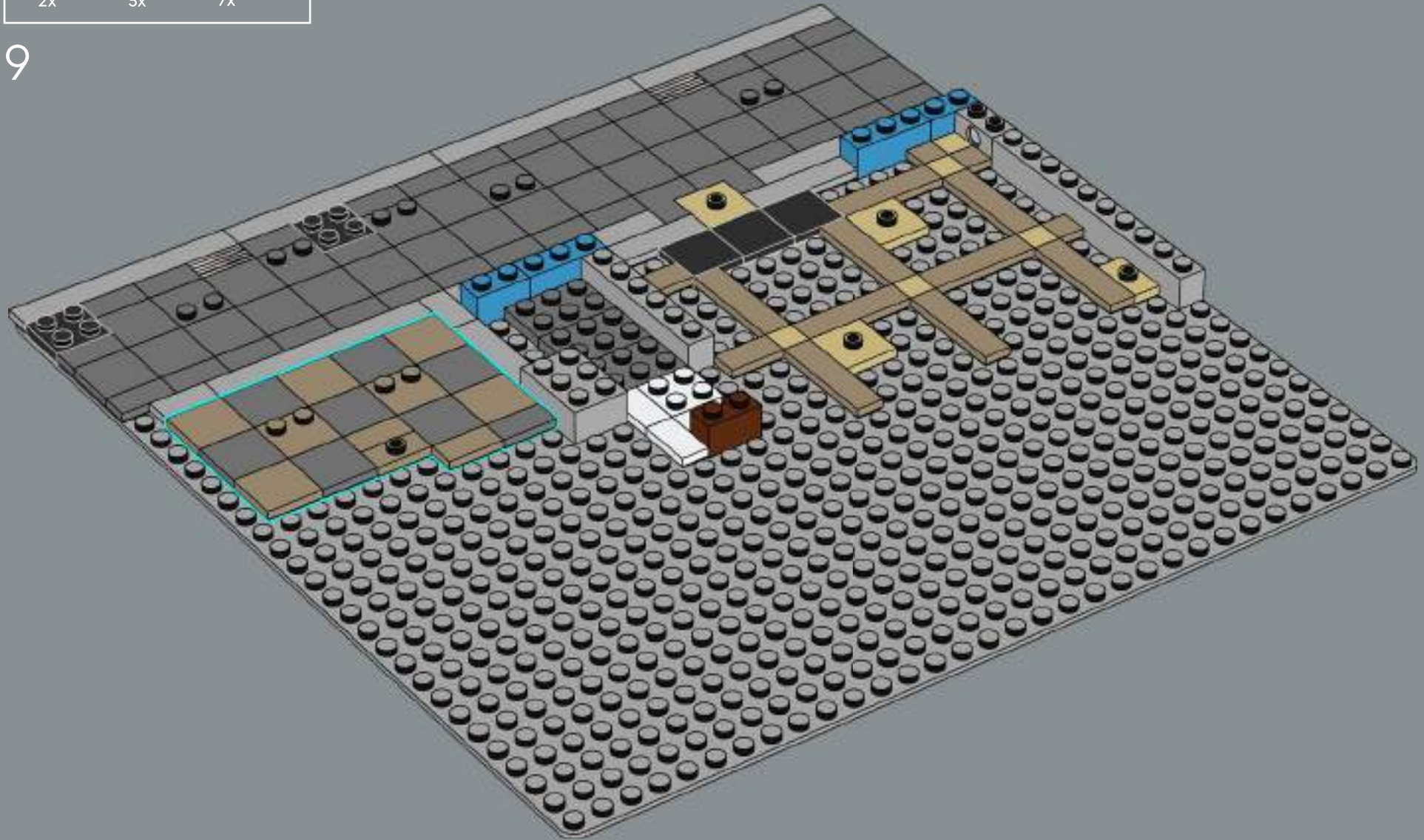

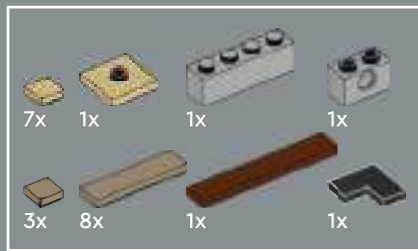

The placement of these elements creates a line angled at 45 degrees to the overall LEGO® grid. You'll find builds and elements oriented at 45 degrees used as a motif throughout the Jazz Club.

11

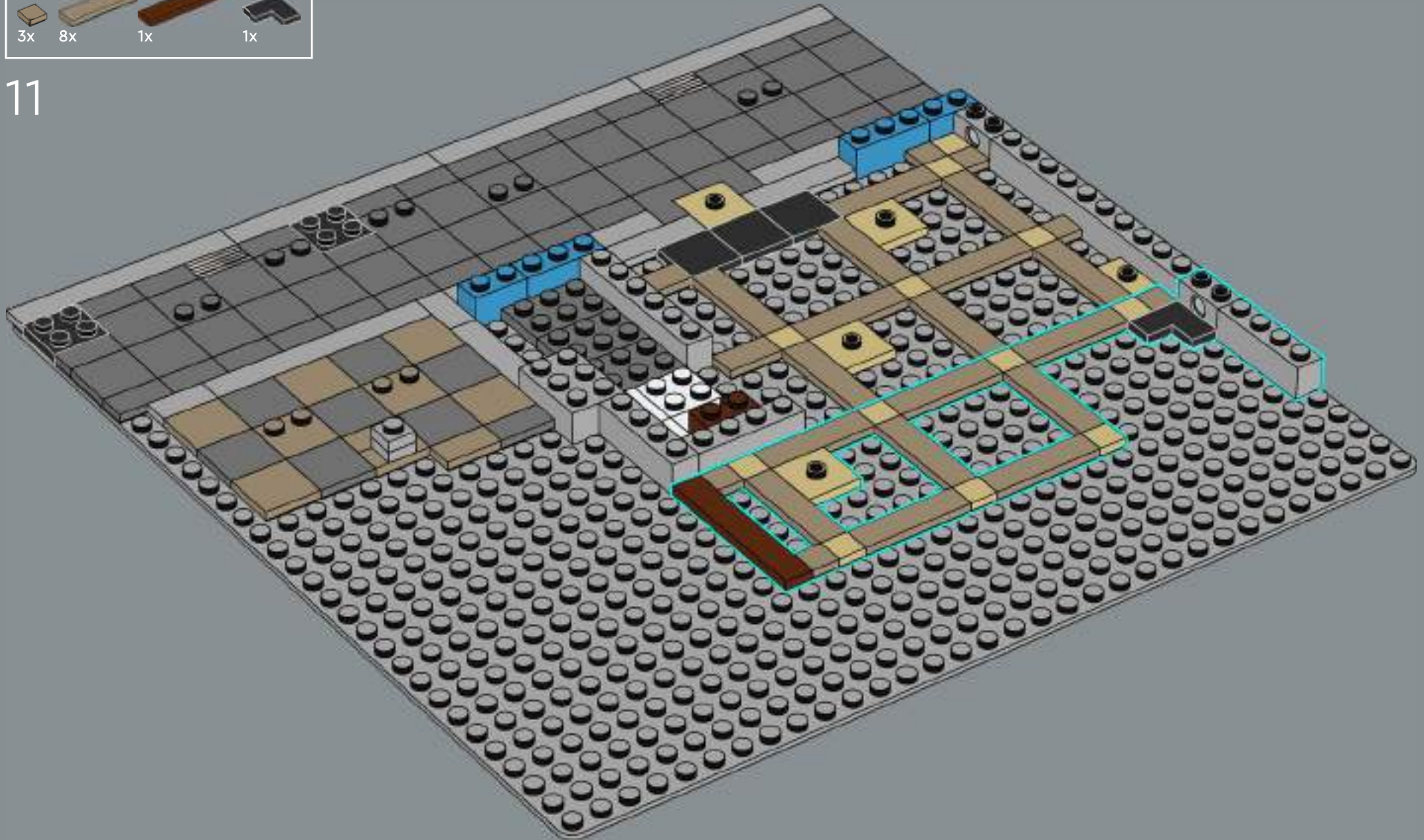

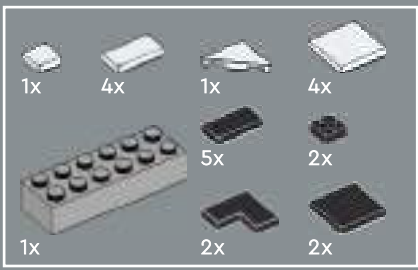

12

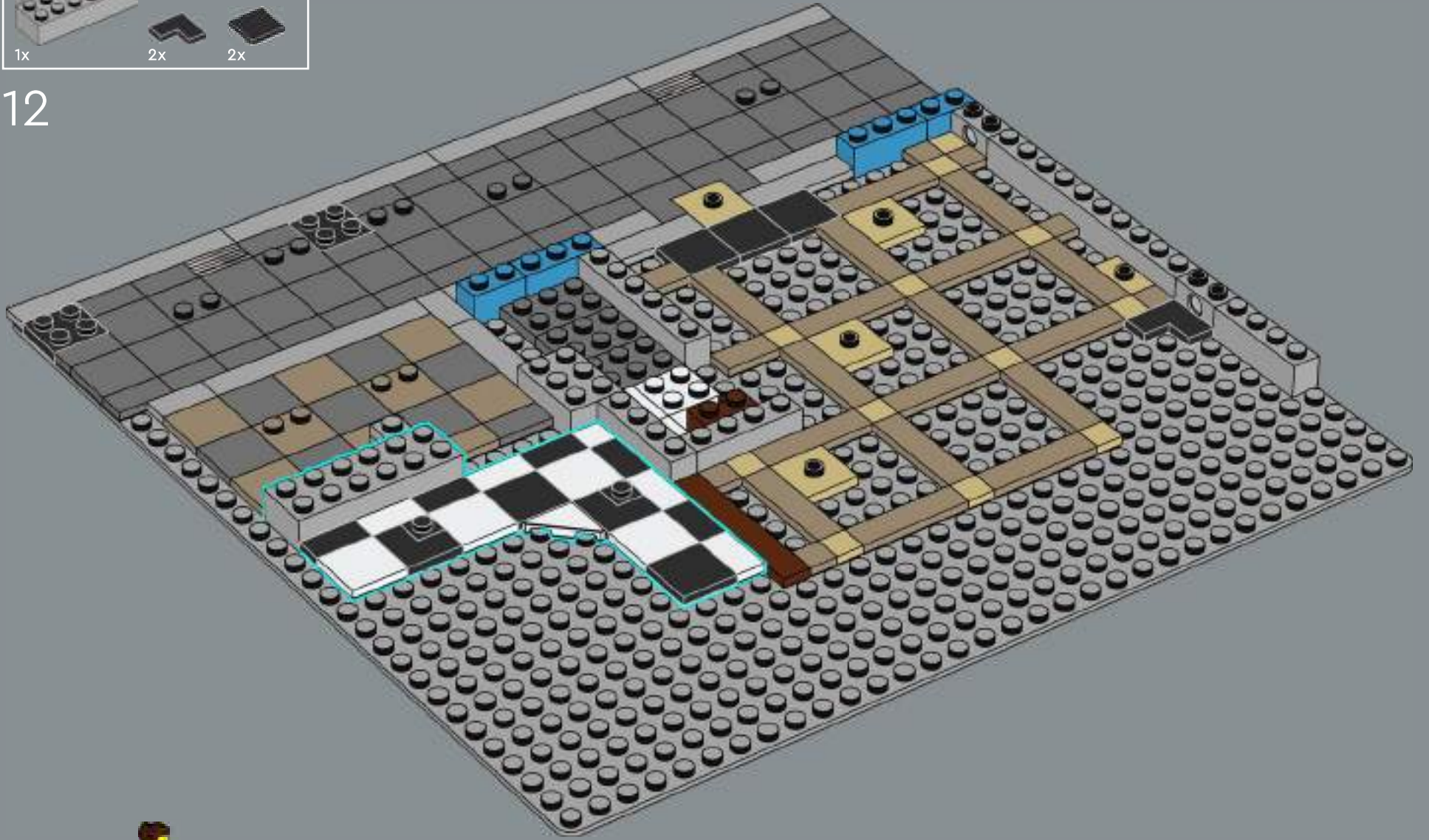



13

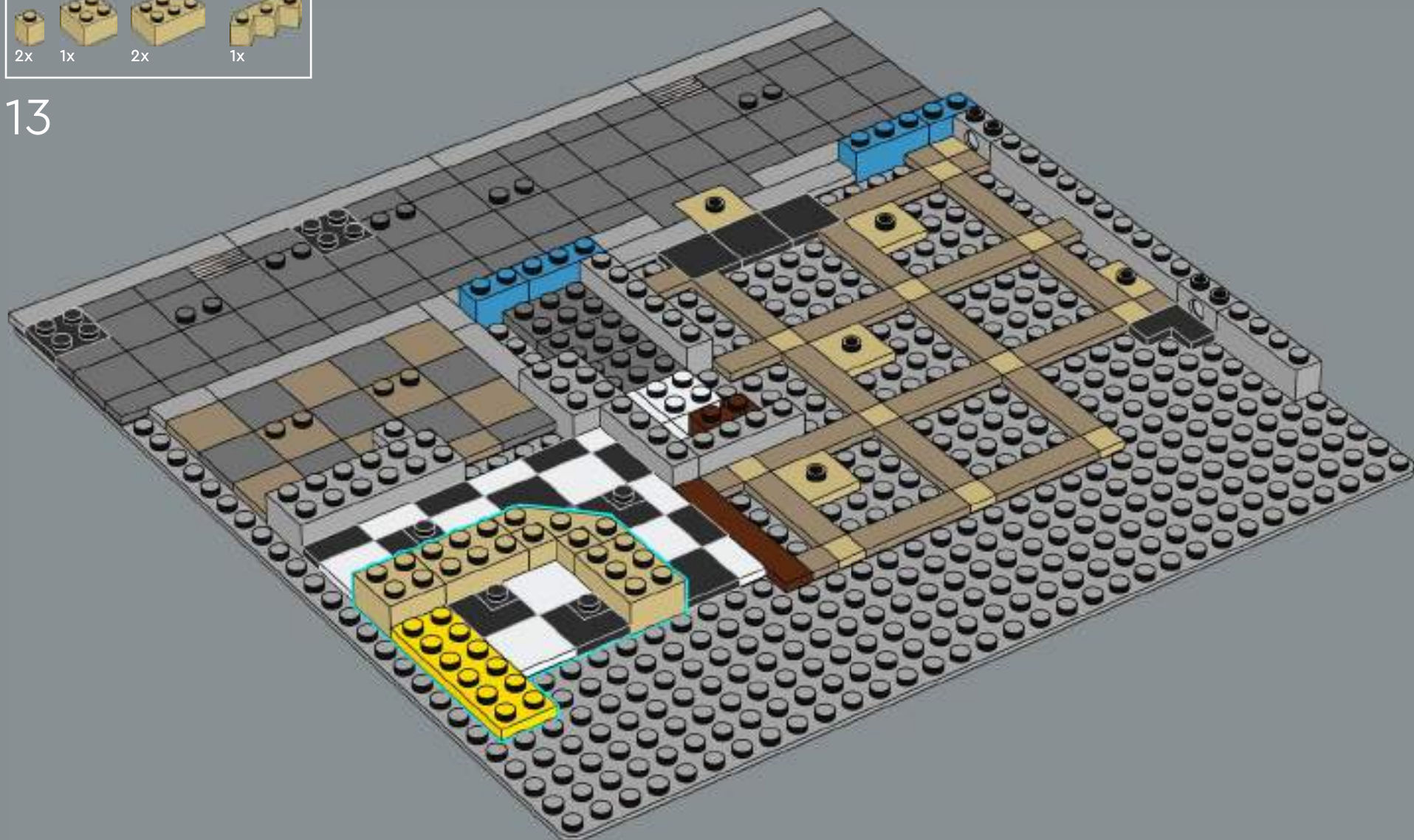



14

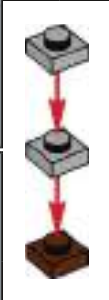
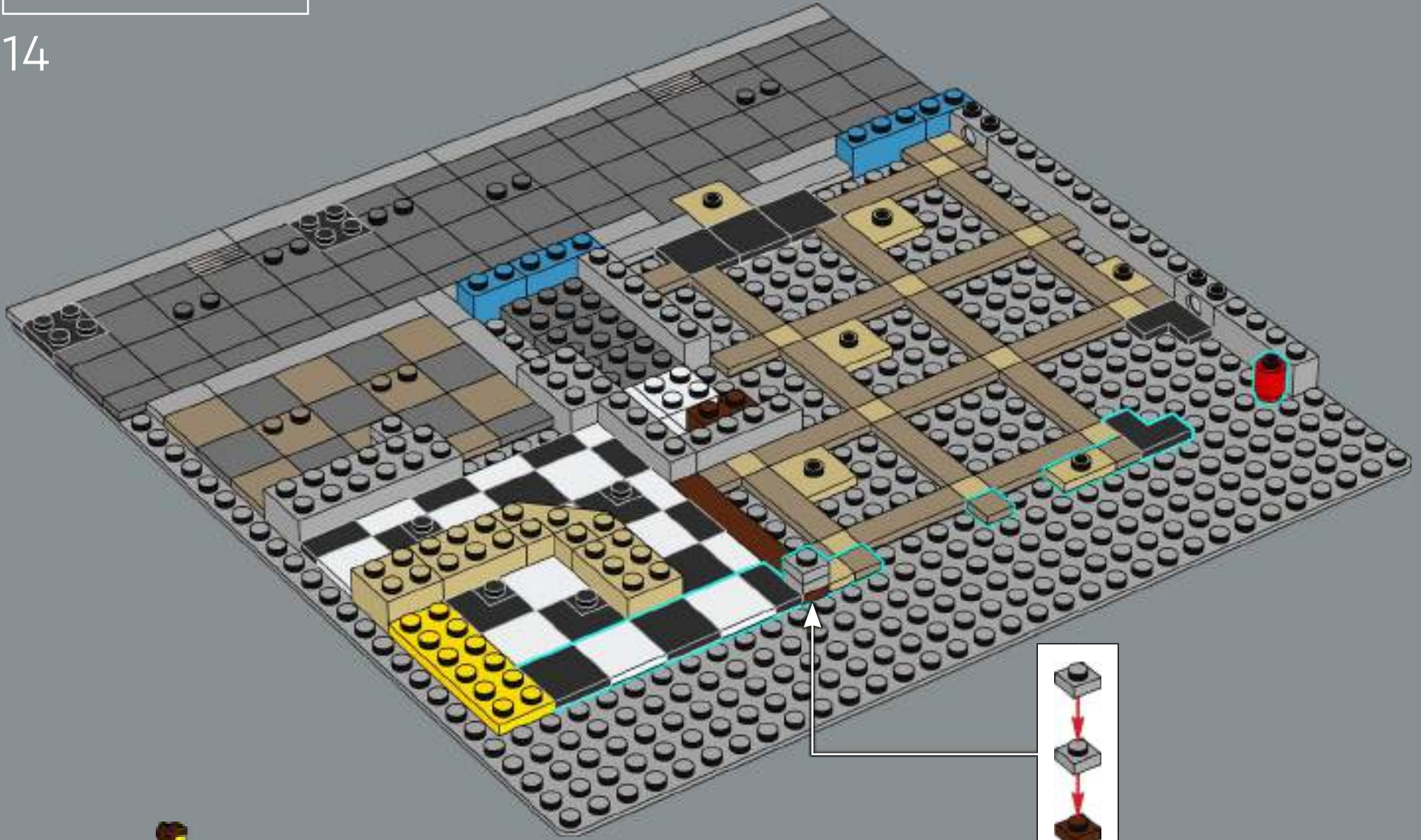

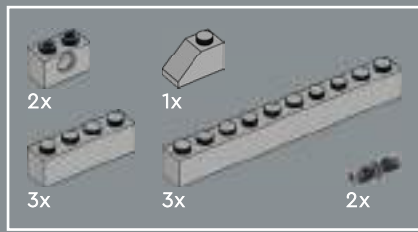

15

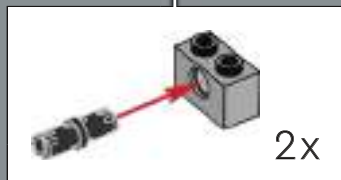
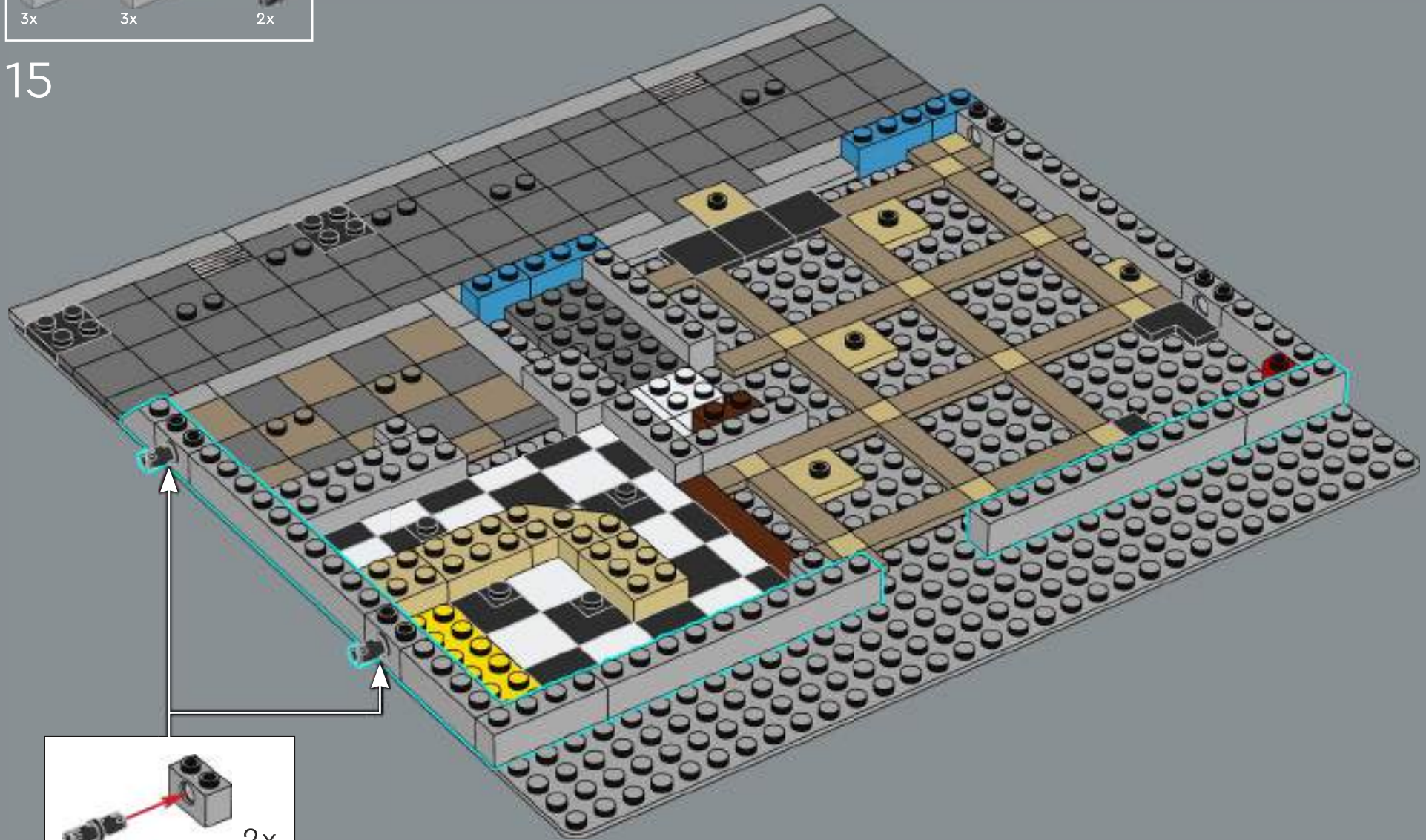

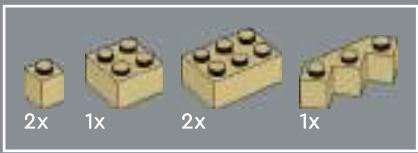

16

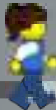
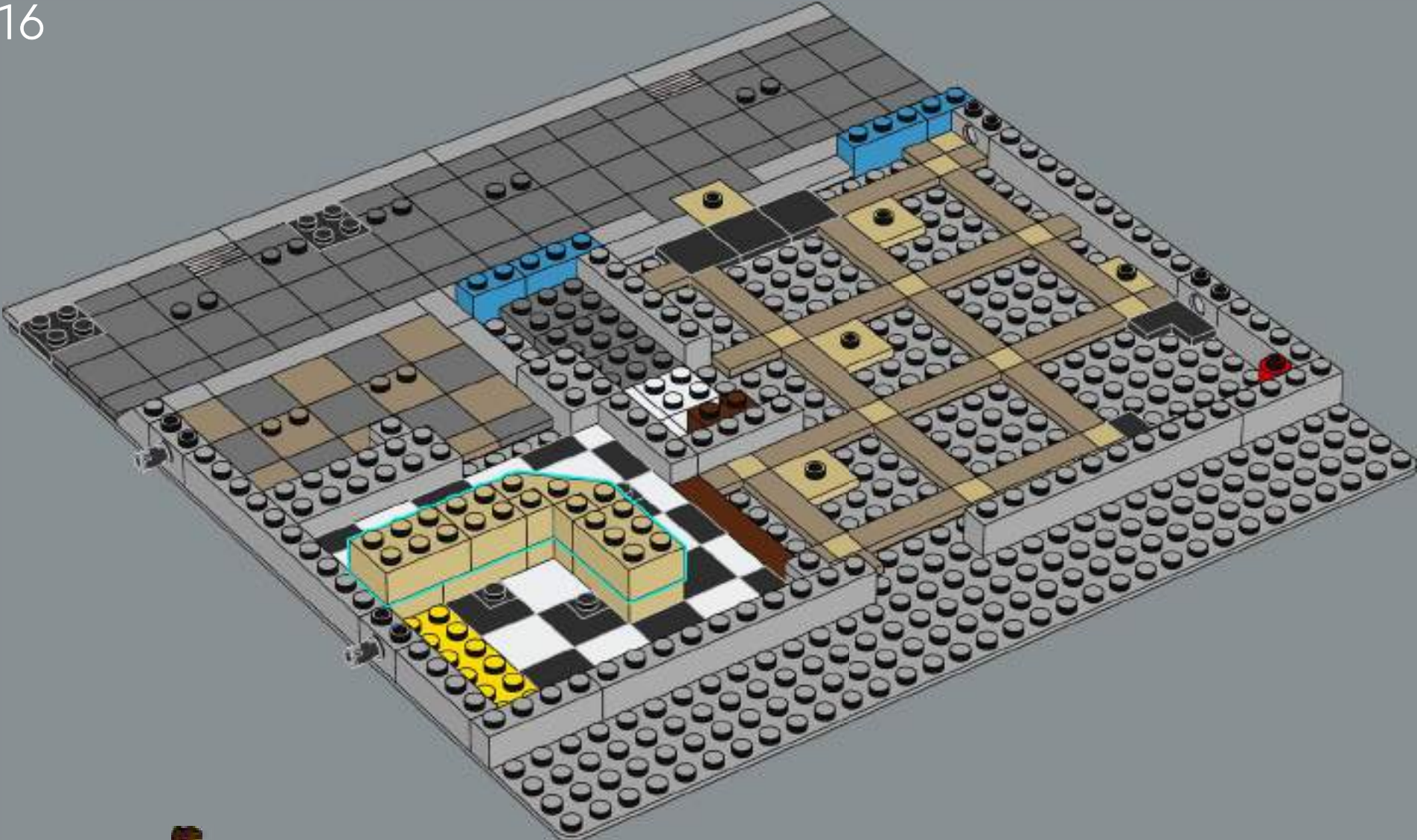



The drummer is excited to try out the new drum kit for sale at the music shop located in the LEGO® 10255 Assembly Square.

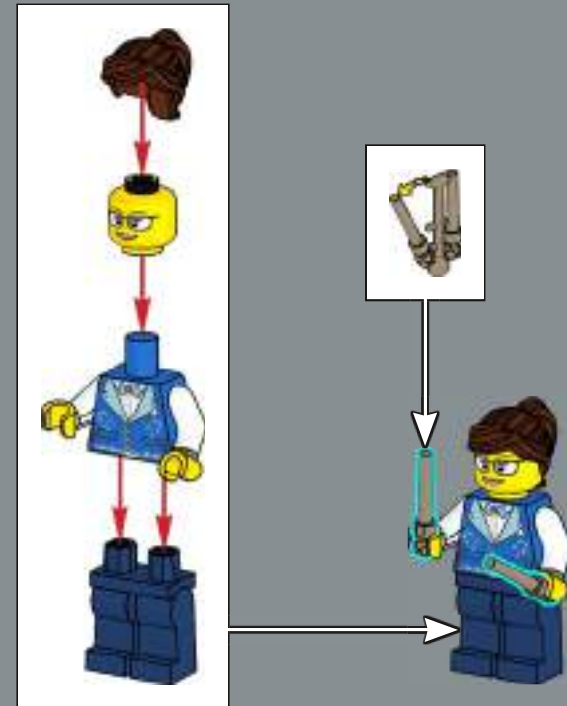

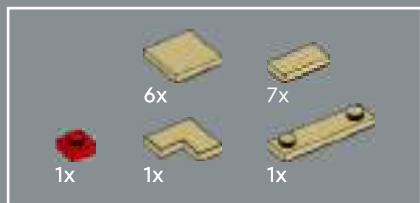

17

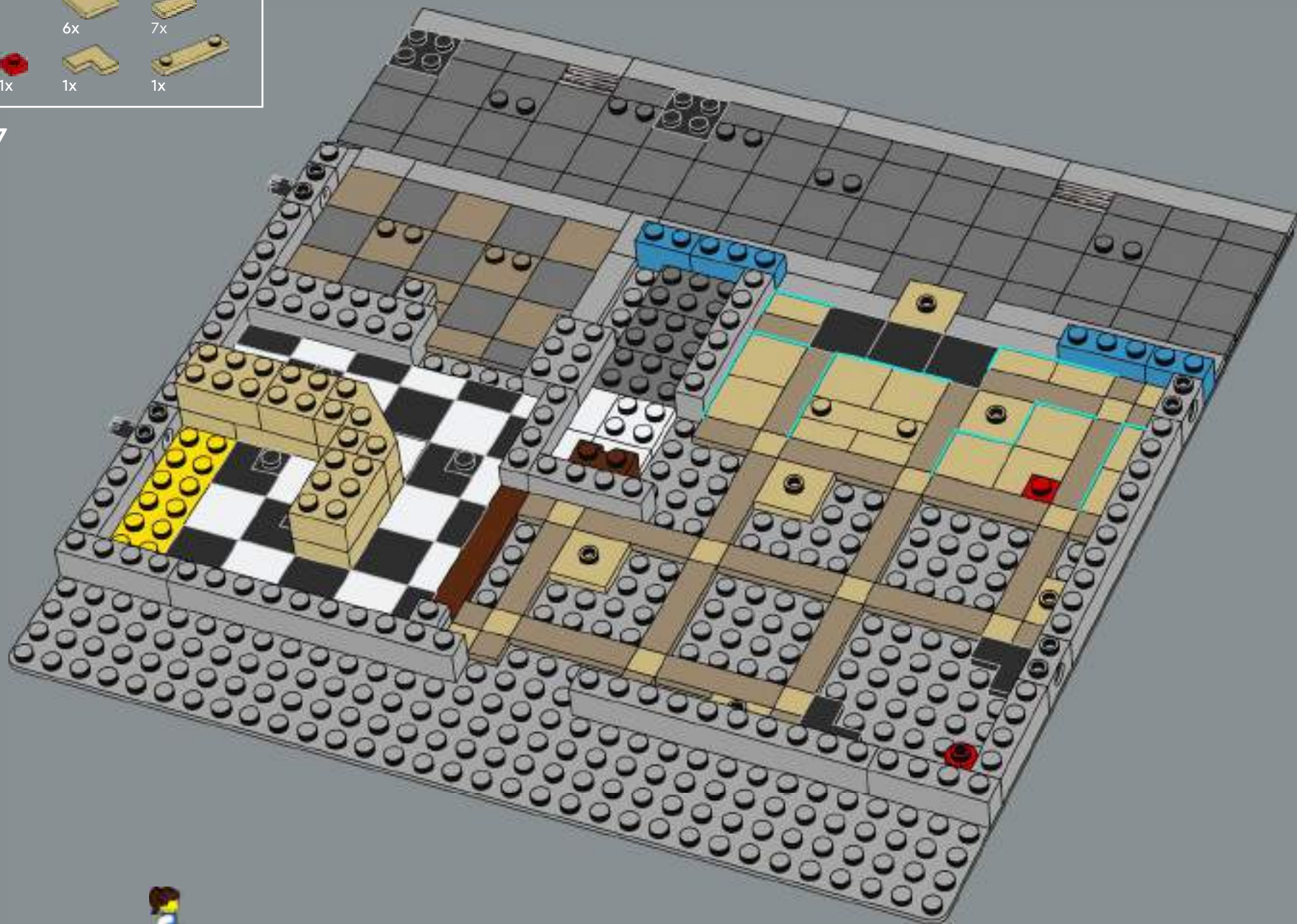

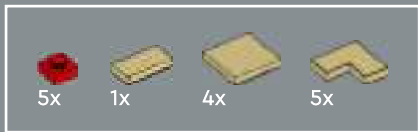

18

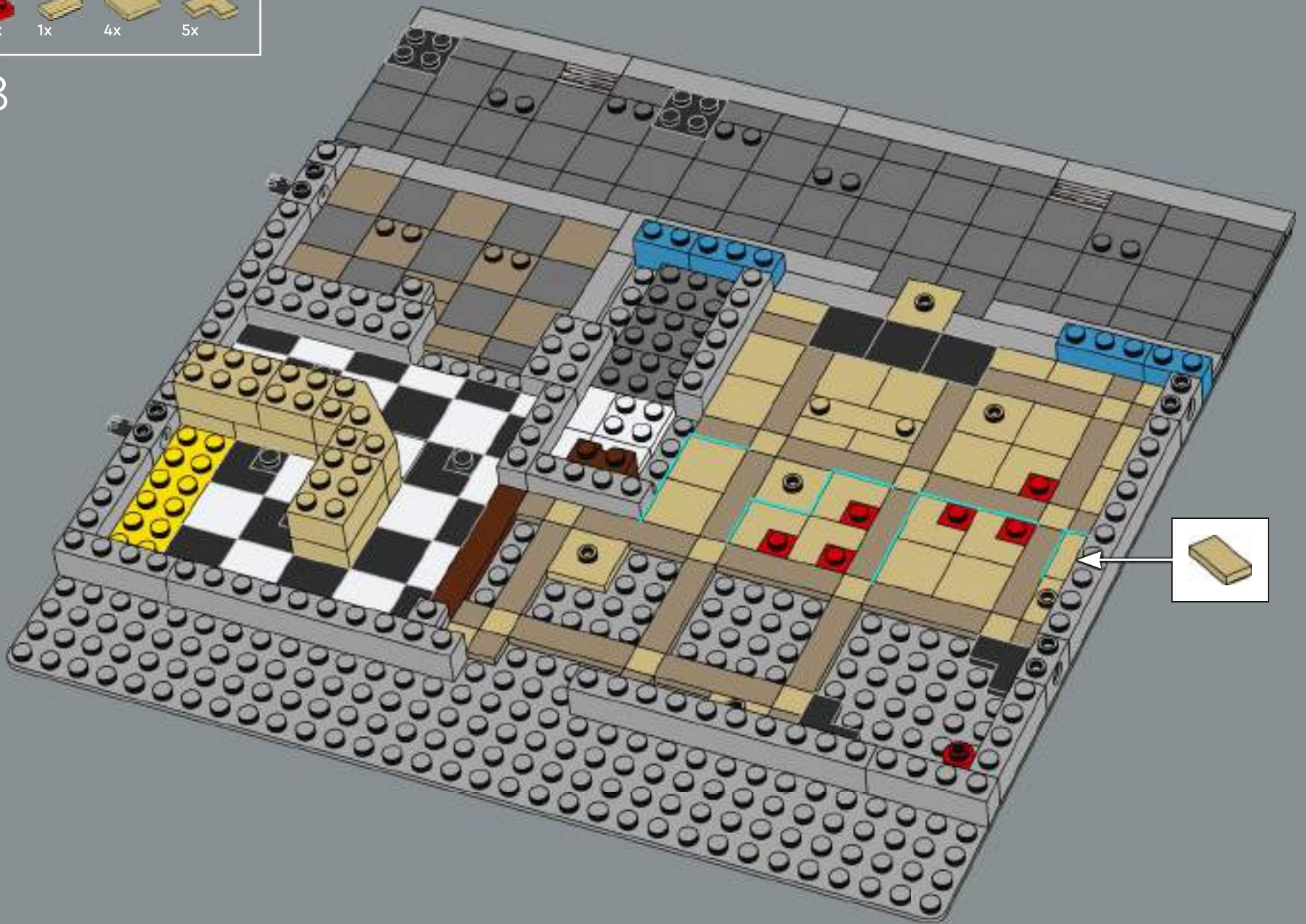

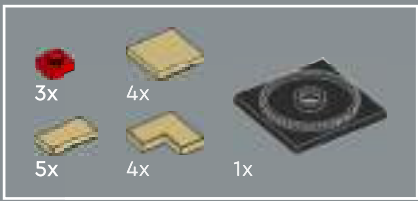

19

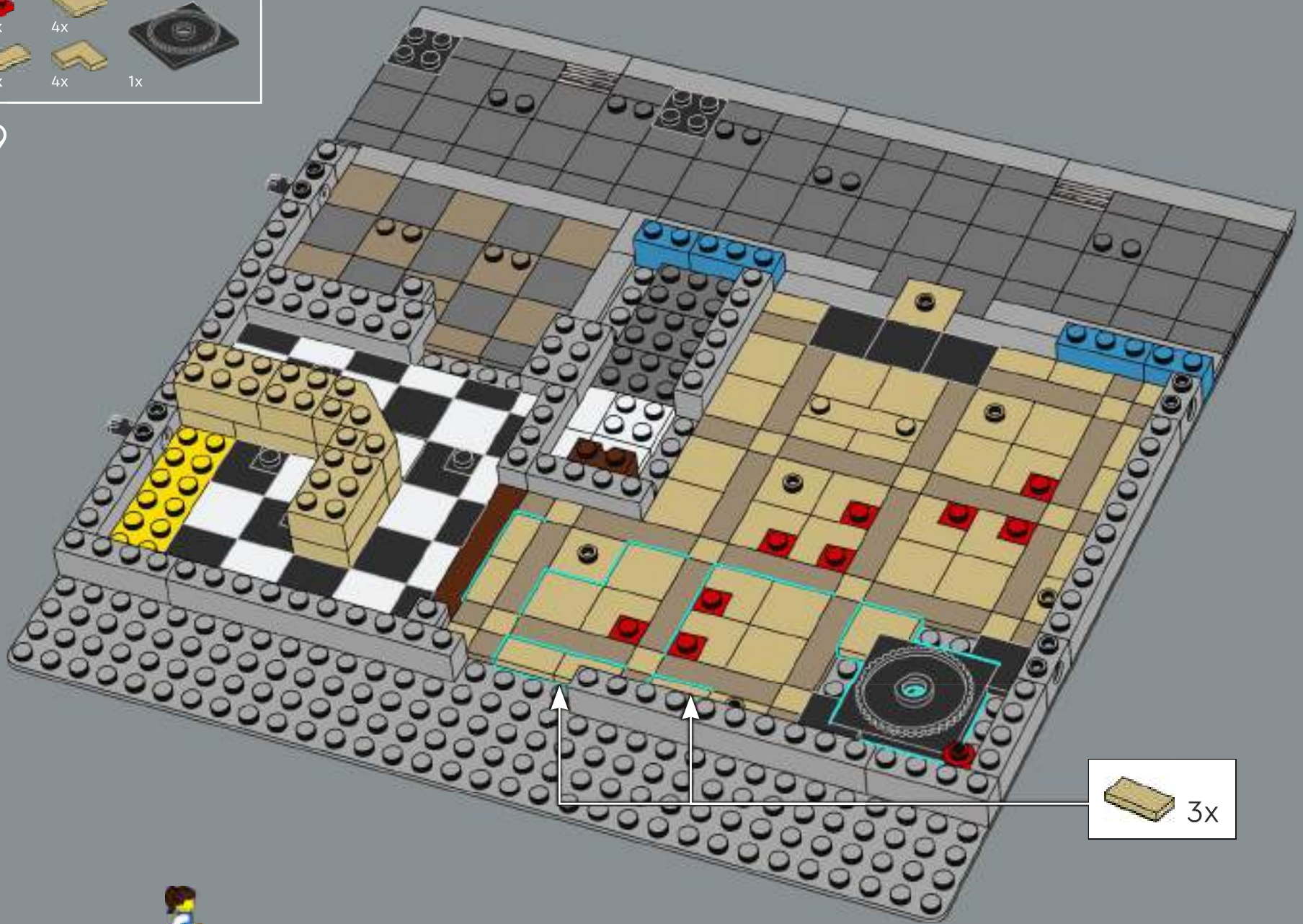

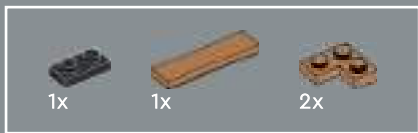

20

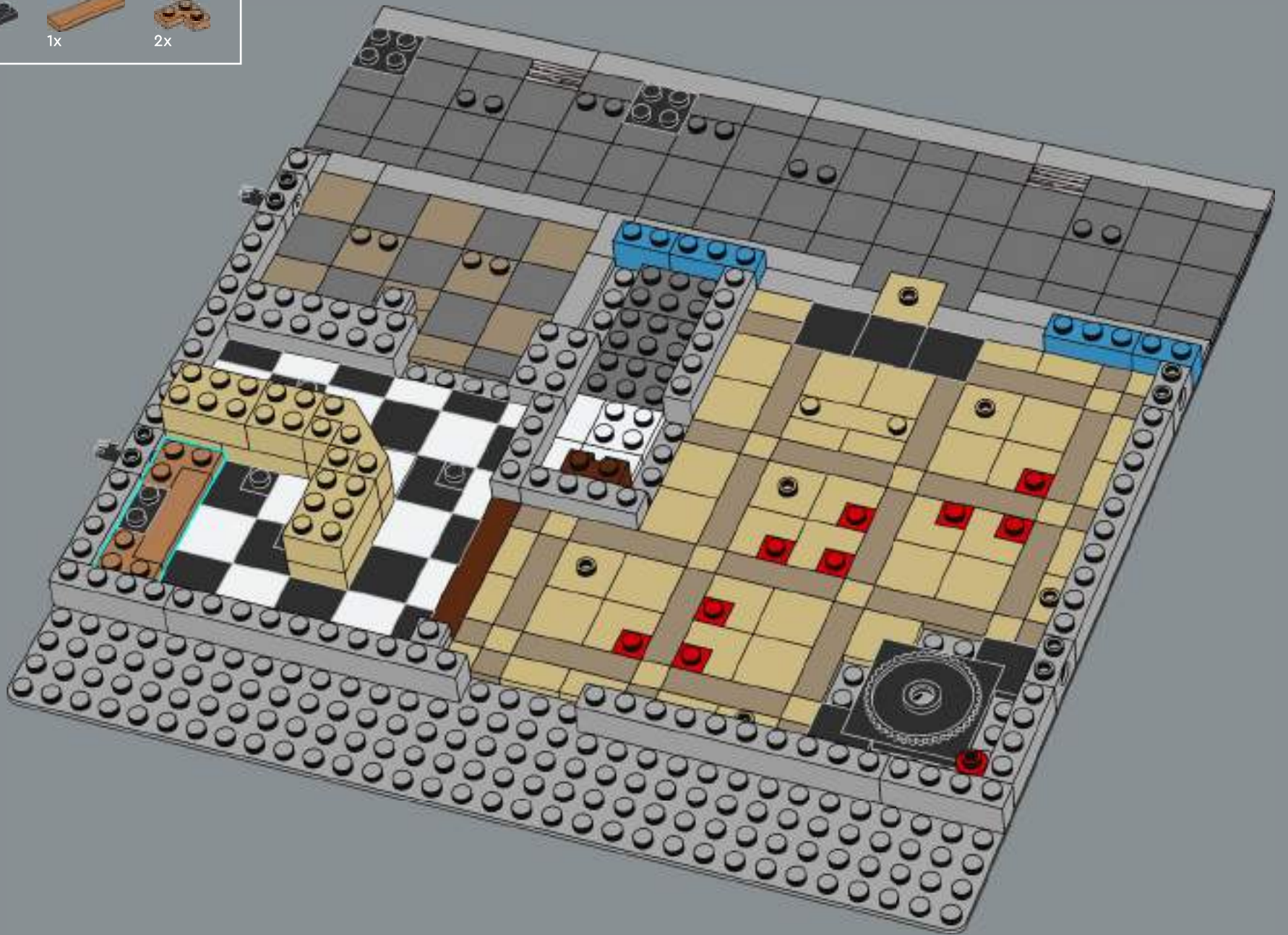

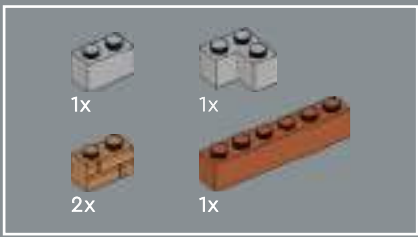

21

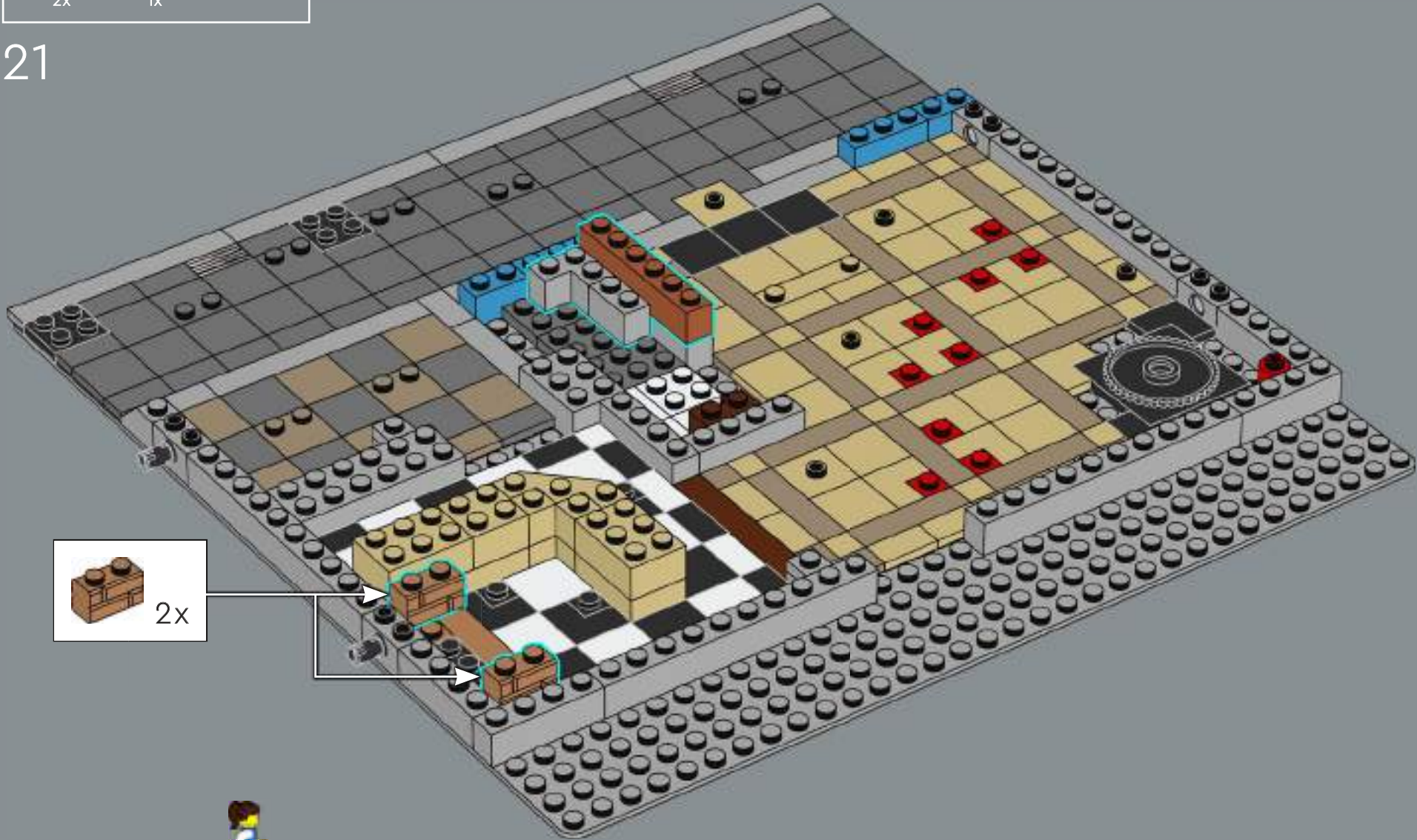



23

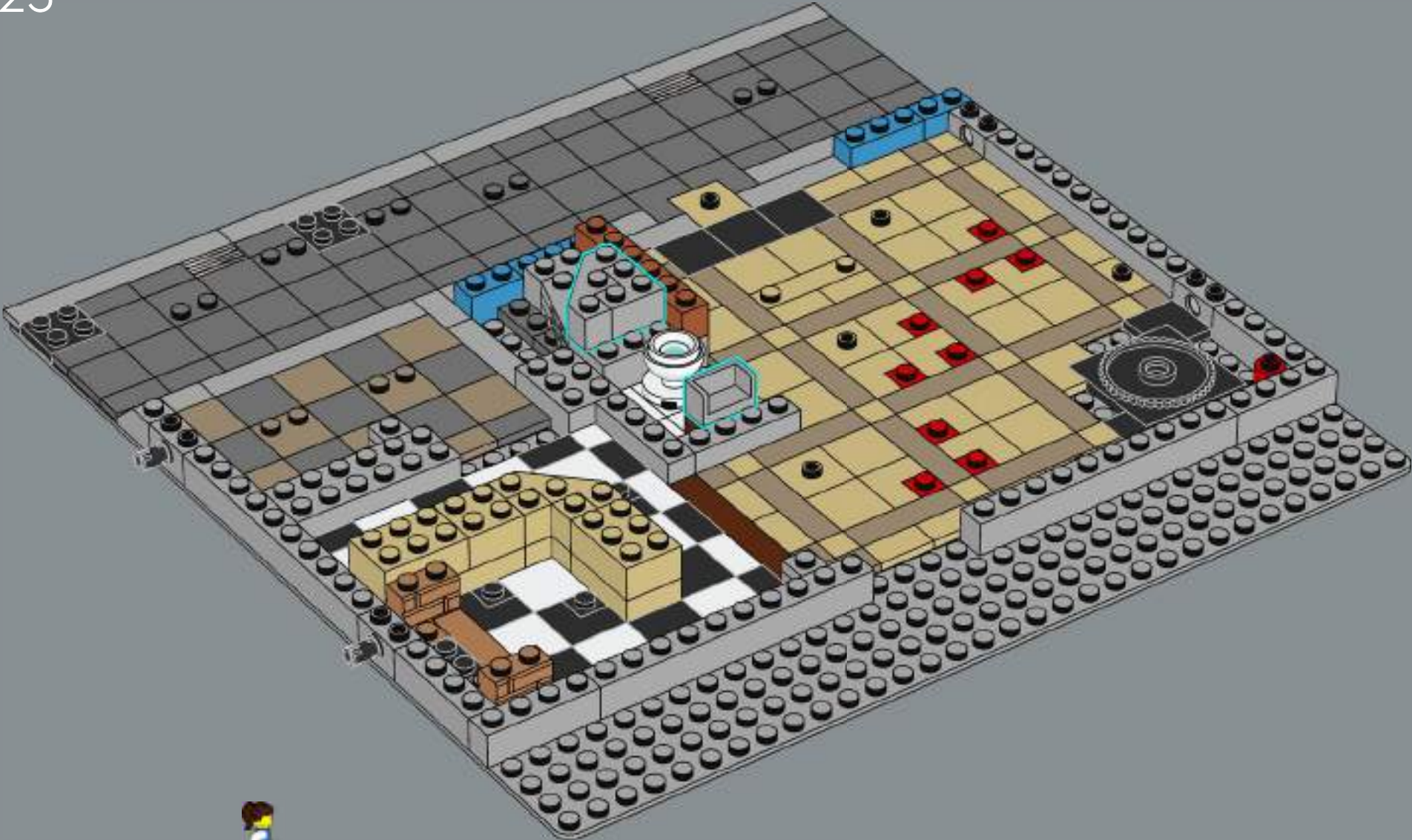

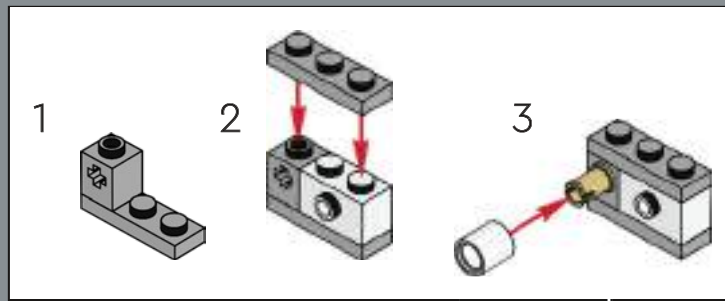
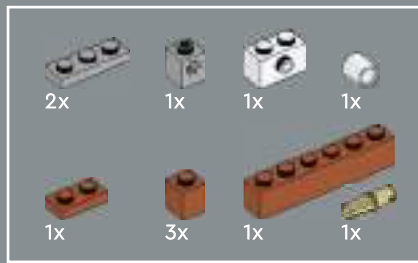

24

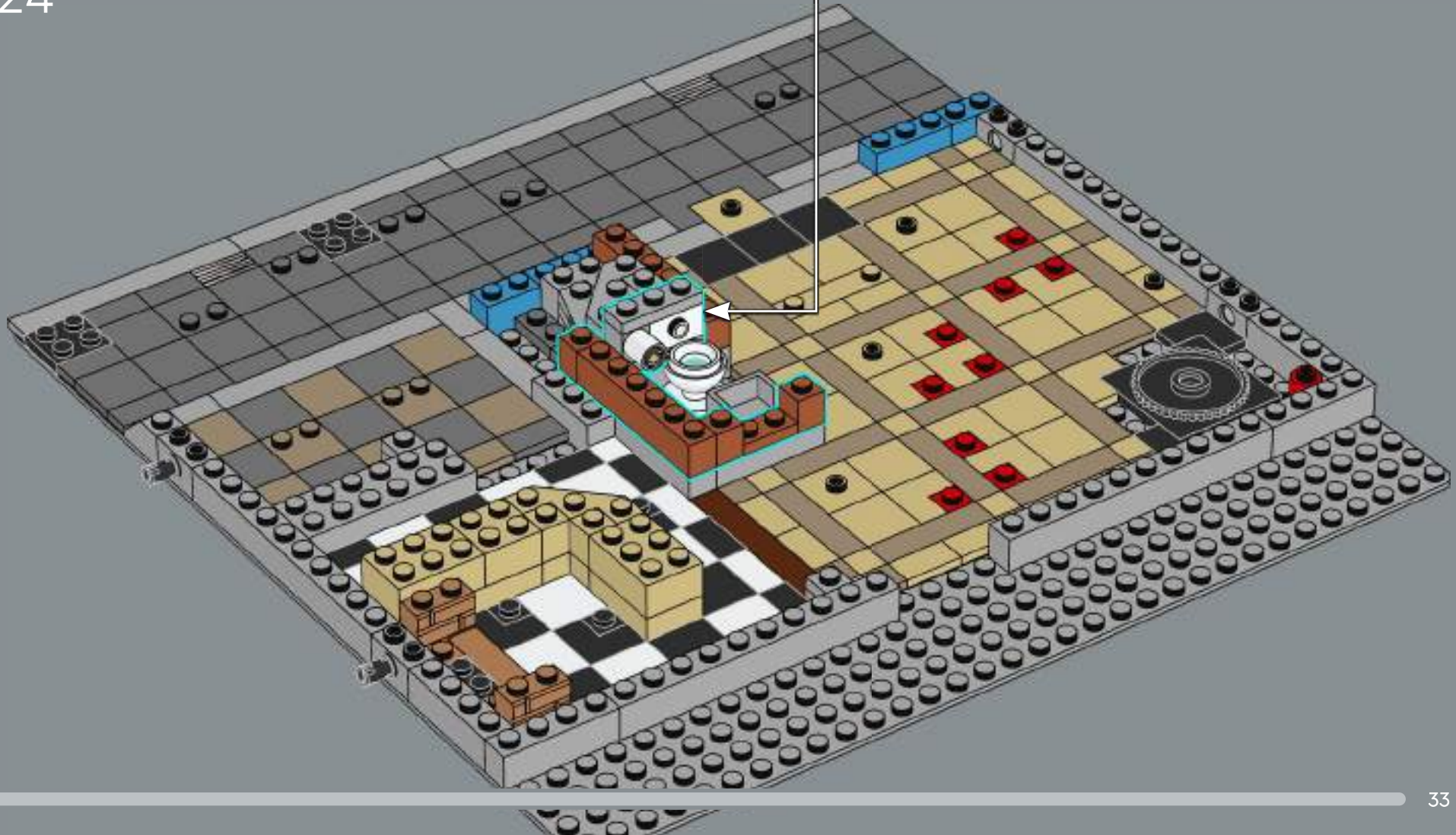

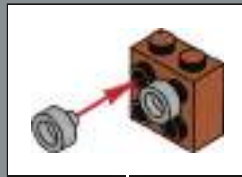
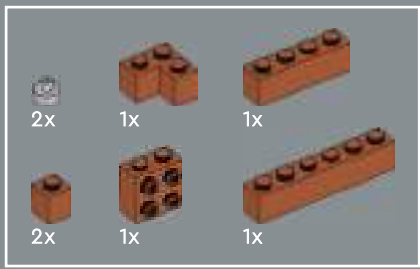

25

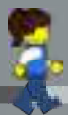
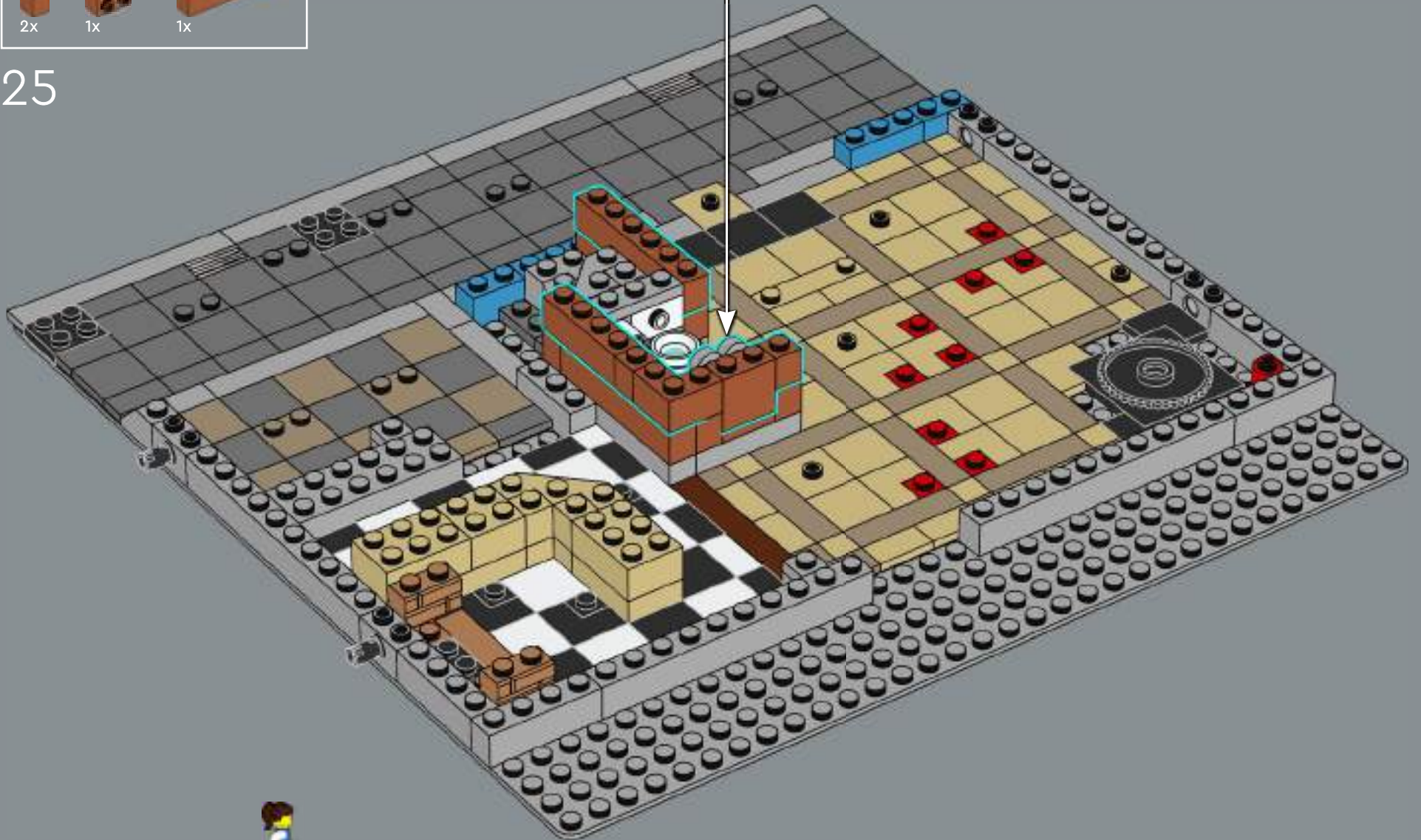

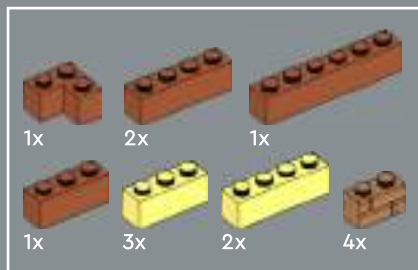

26

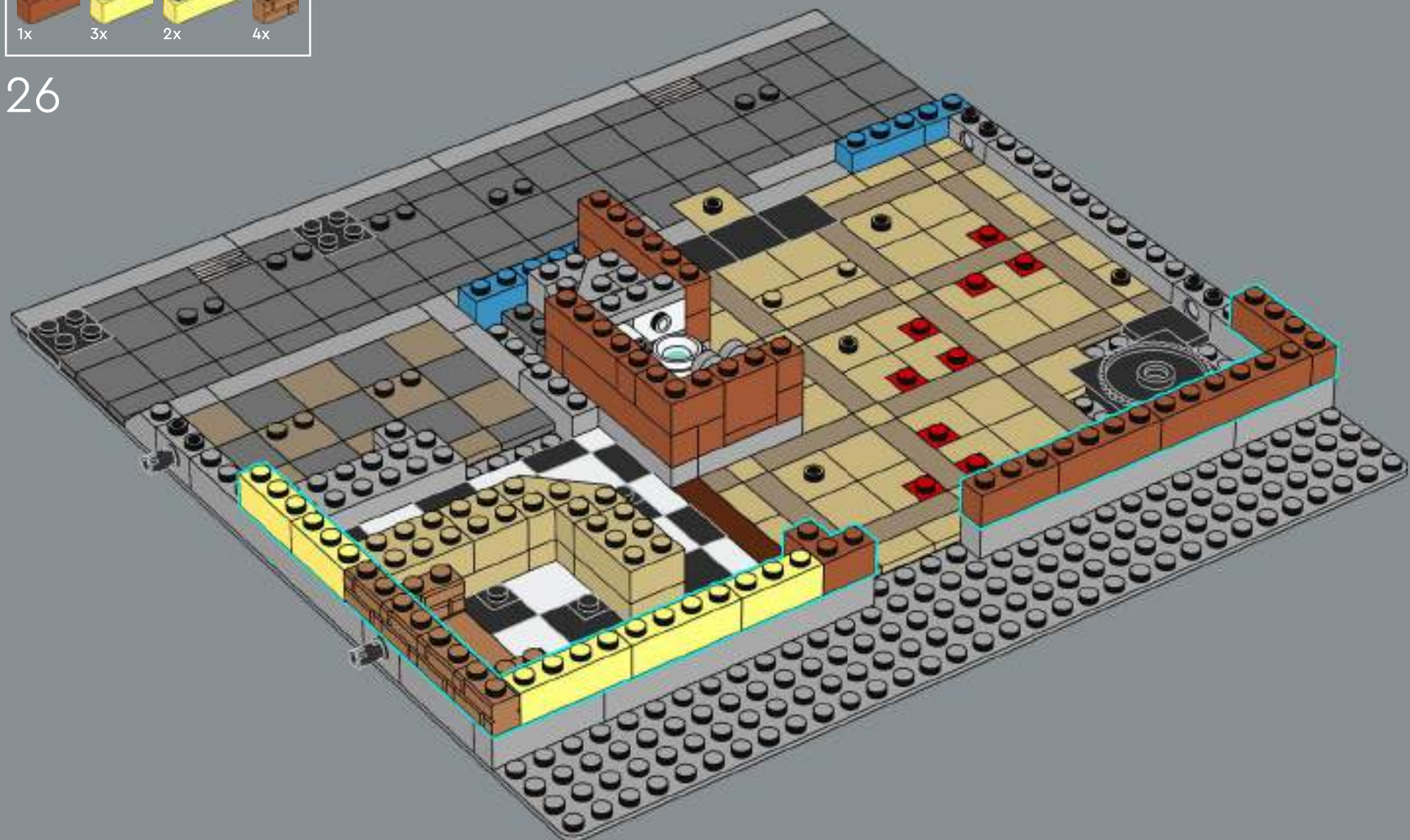

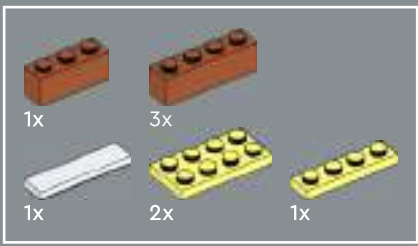

27

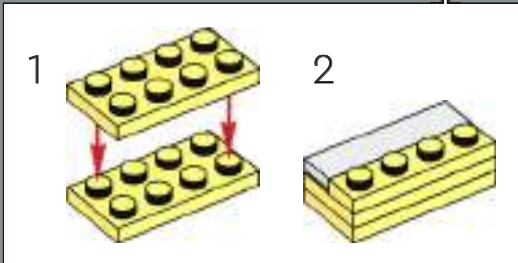
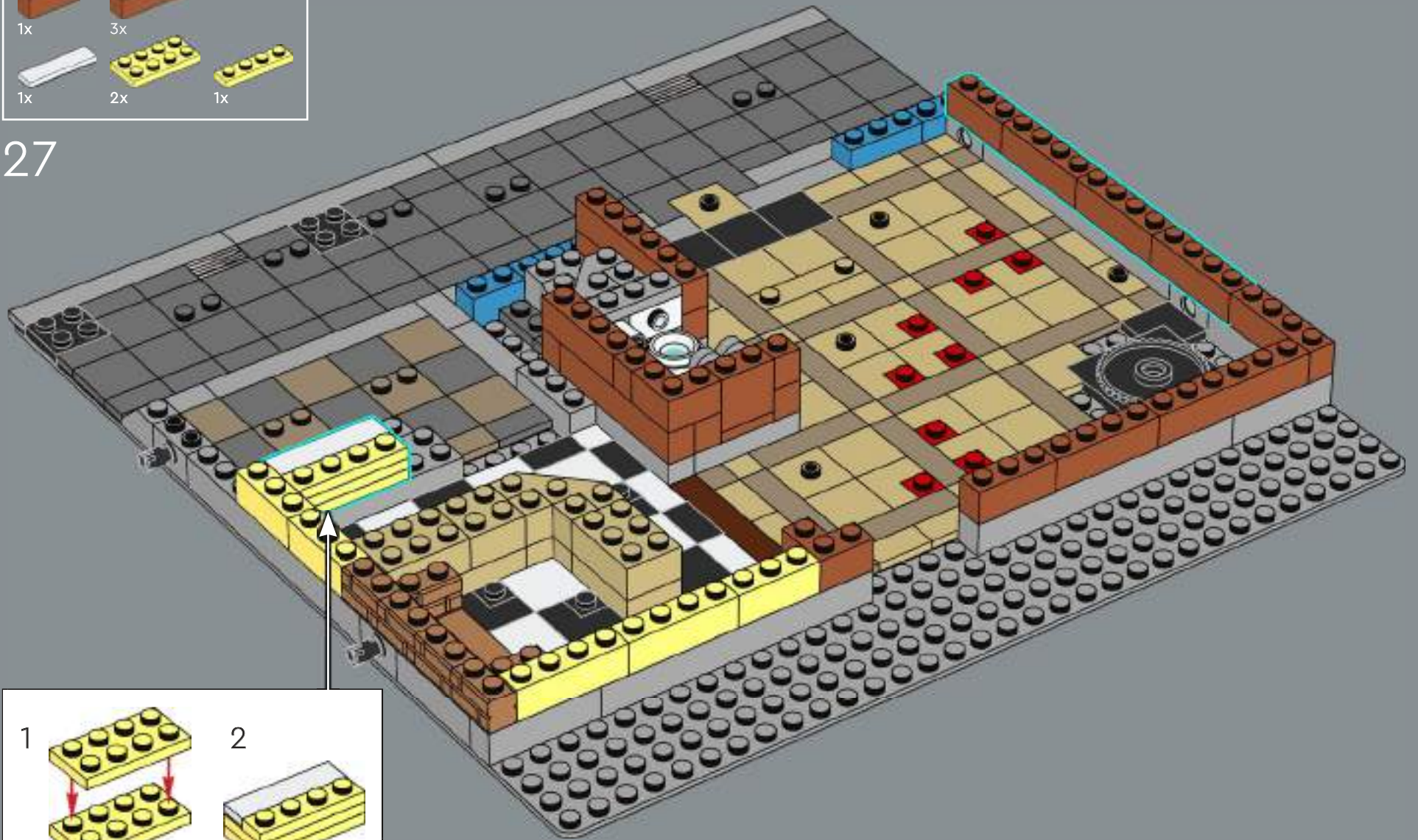



28

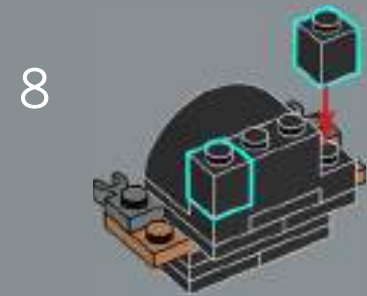
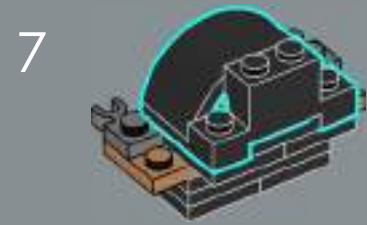
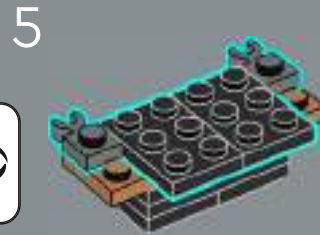
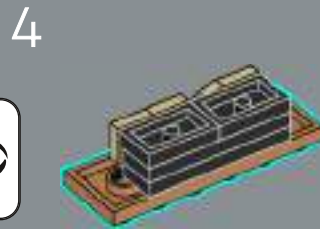
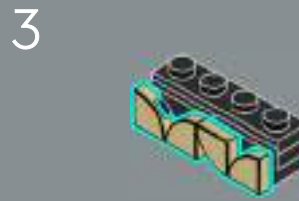
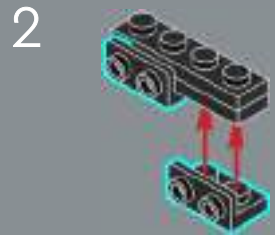
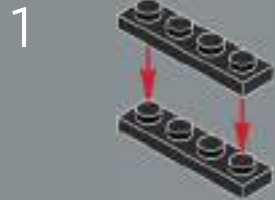

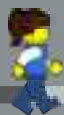
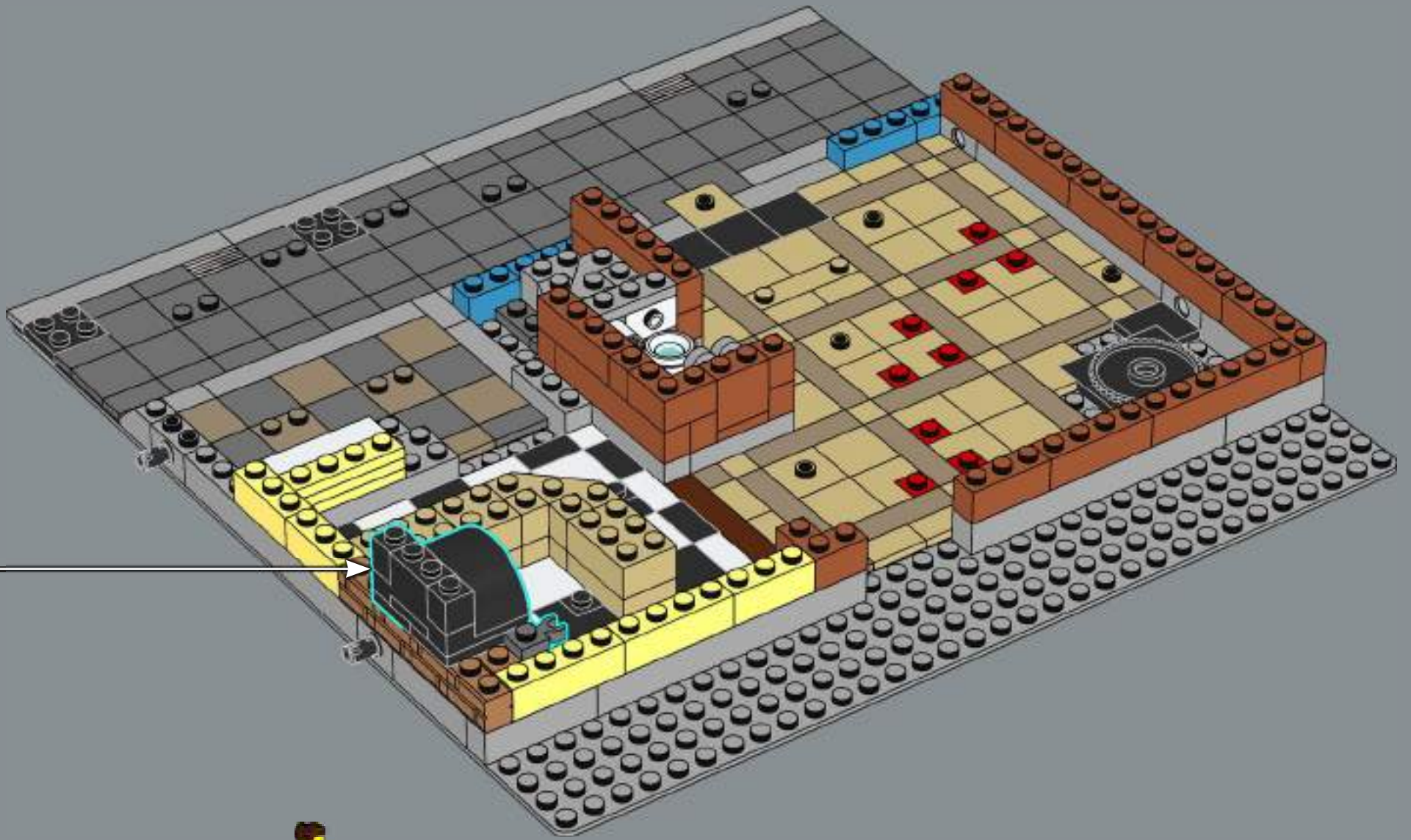

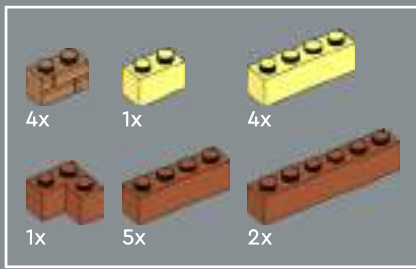

29

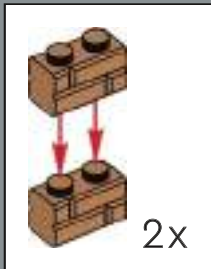
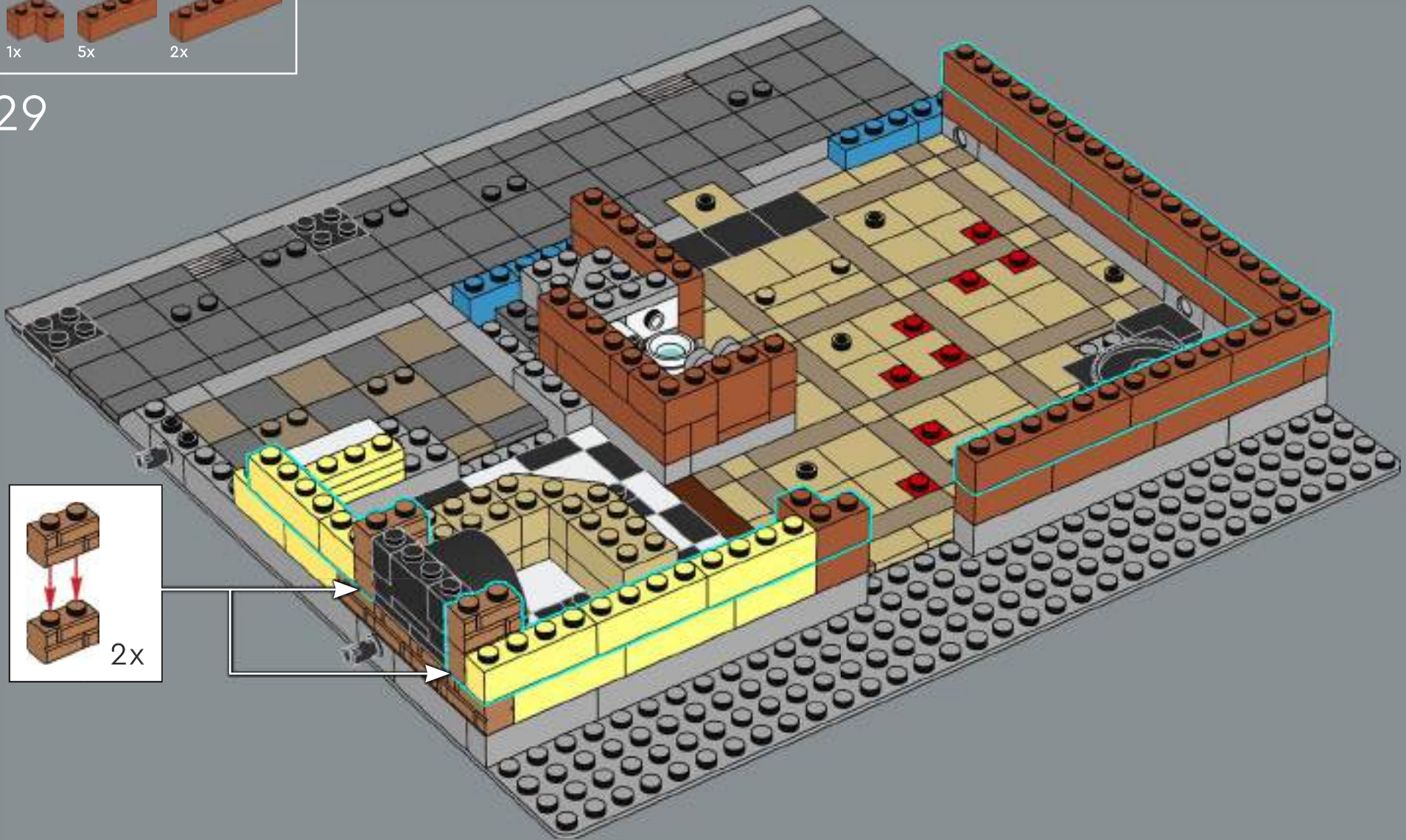

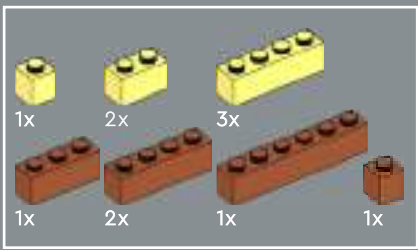

30

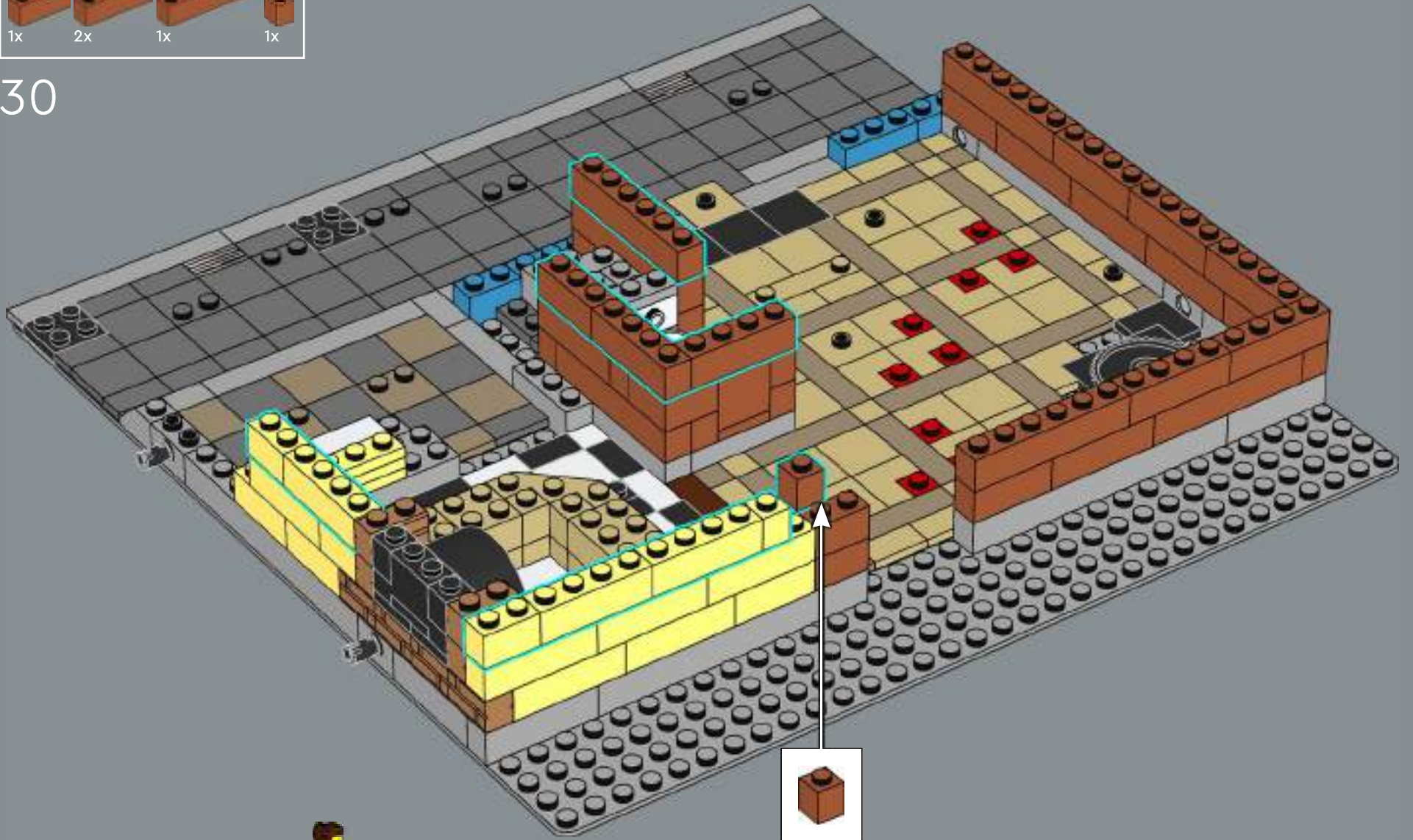



1x

31

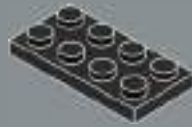

2x

32

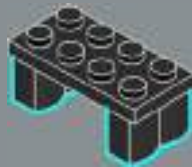

1x

33

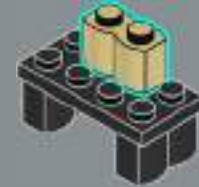

4x

1x

1x

34

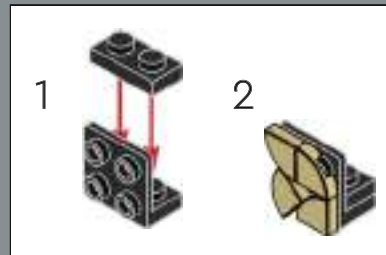

1

2

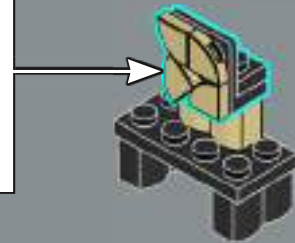

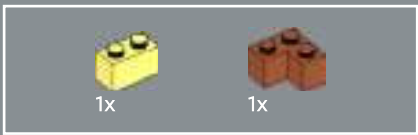

35

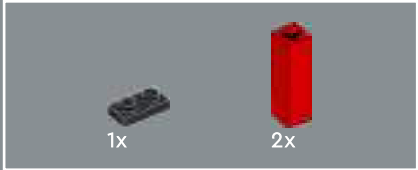

36

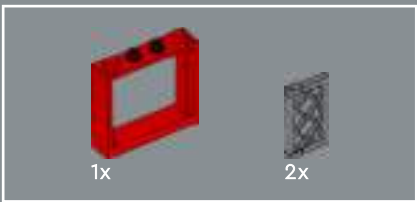
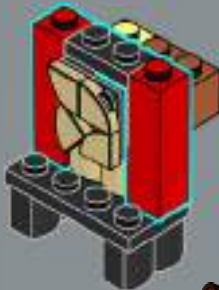

37

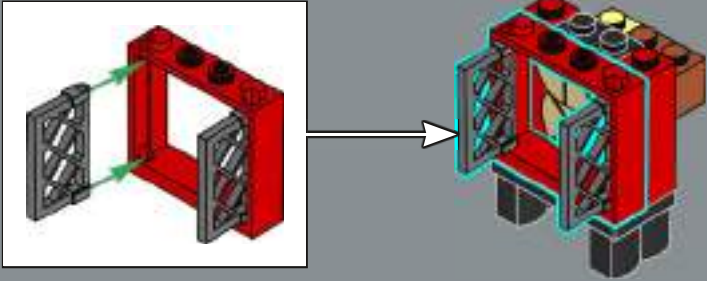

38

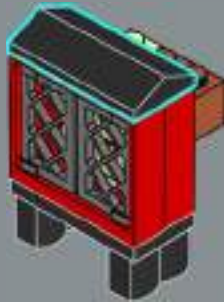



The wood-fired pizza oven is heated up and ready to use. You can find extra wood behind the building.

39

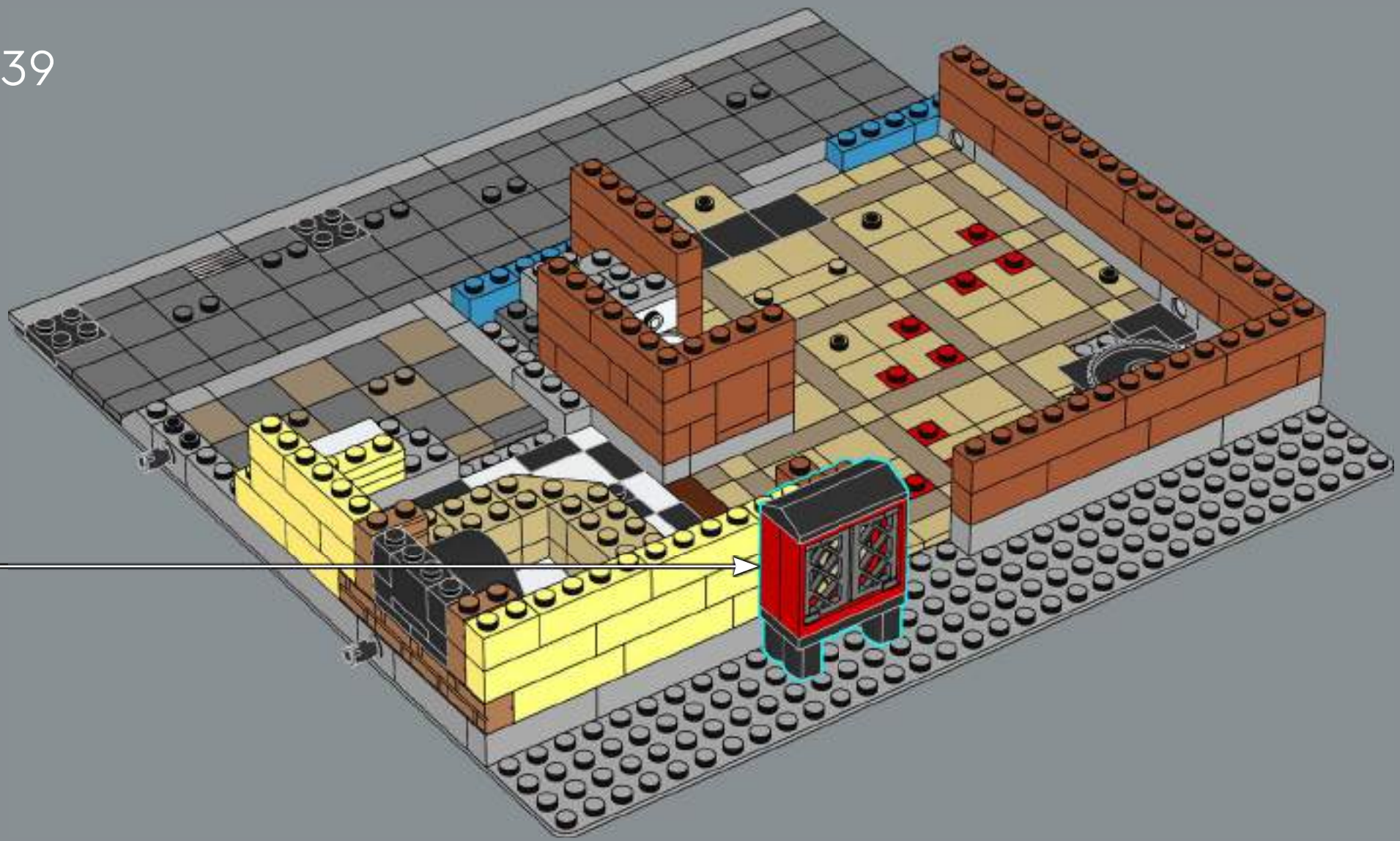

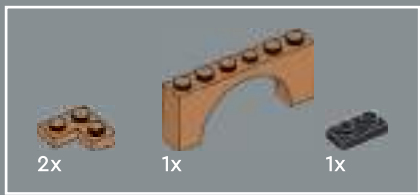

40

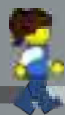
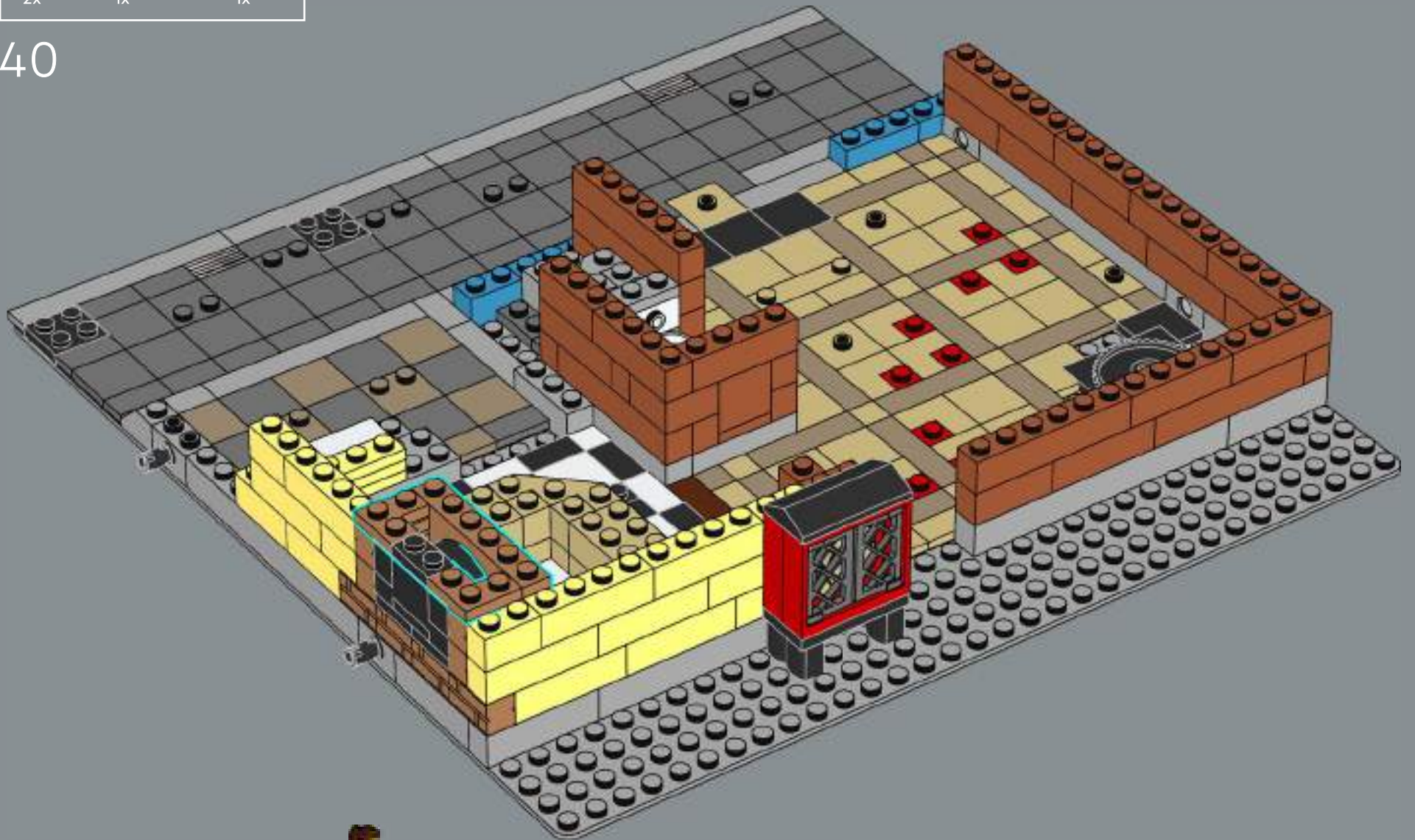

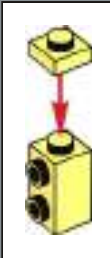
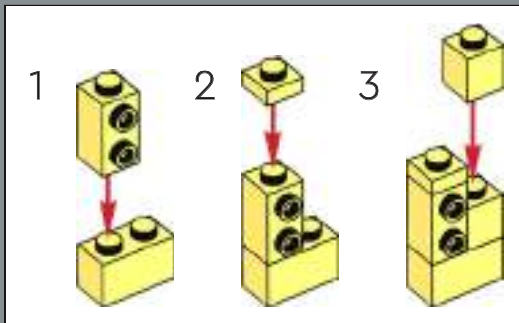
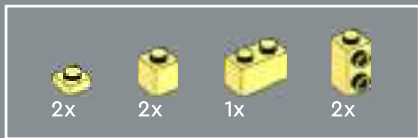

41

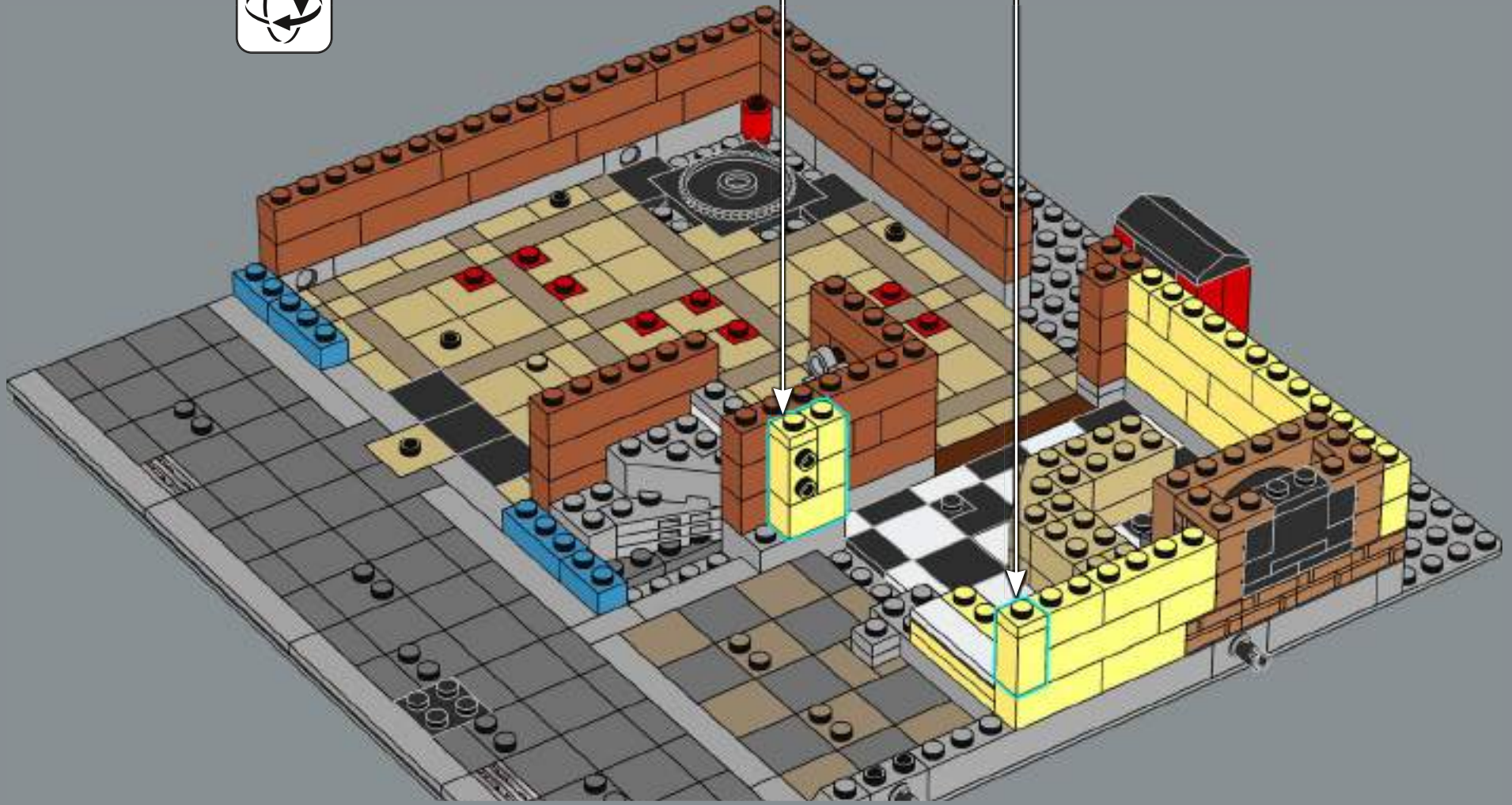

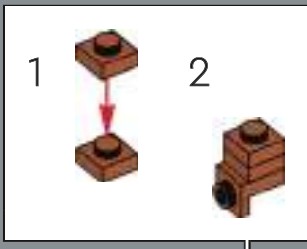
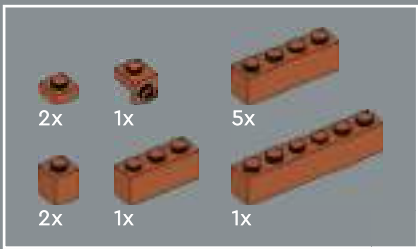

42

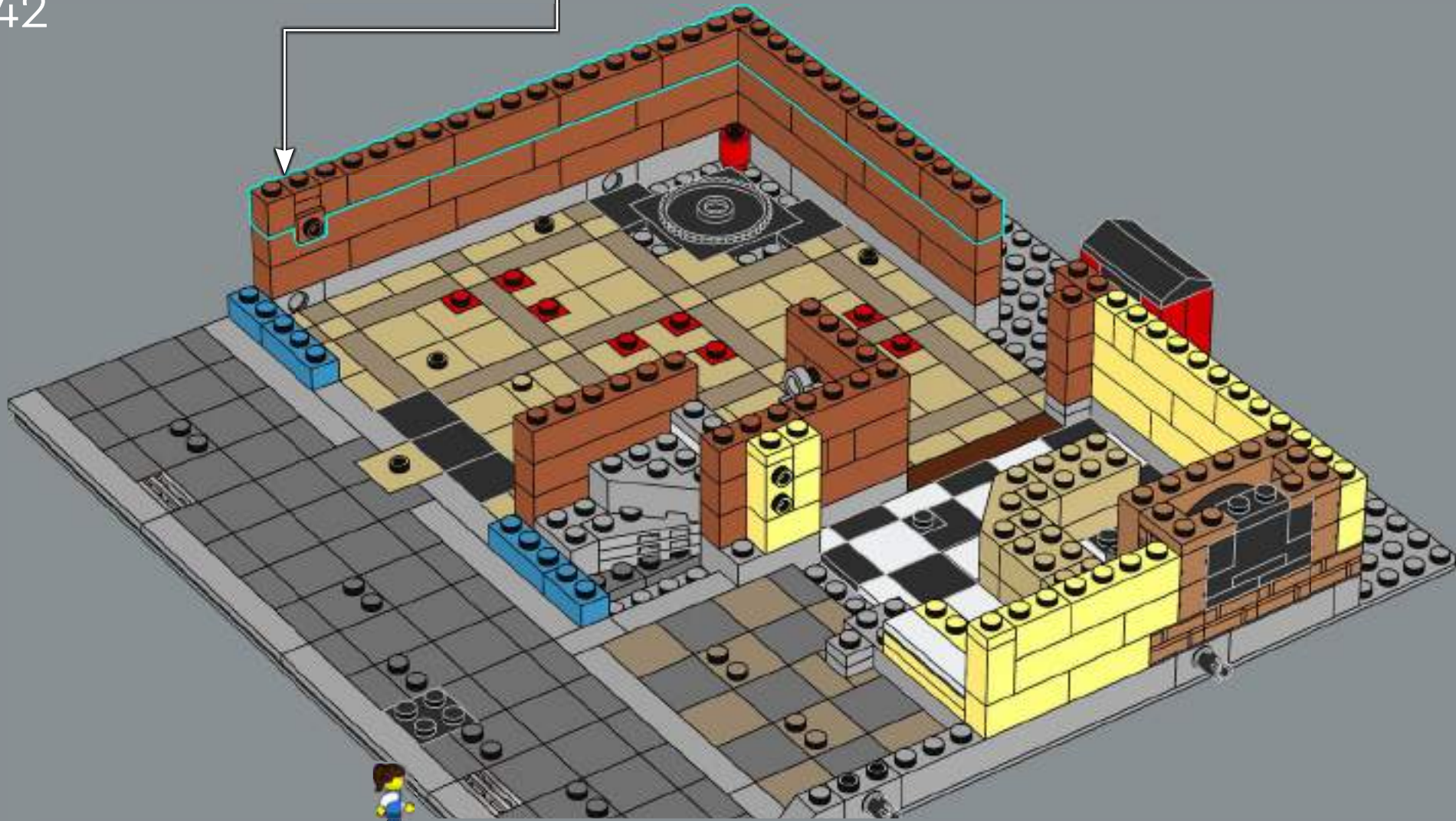

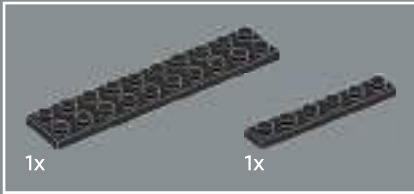

43

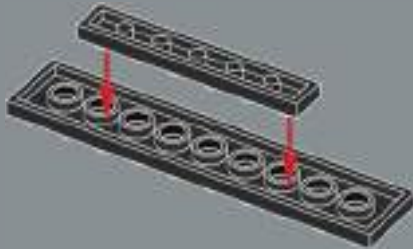

44



45

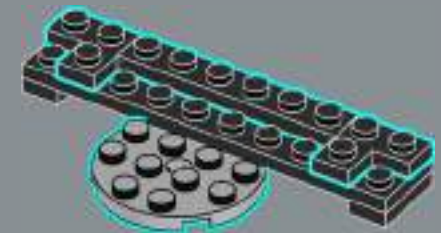



46

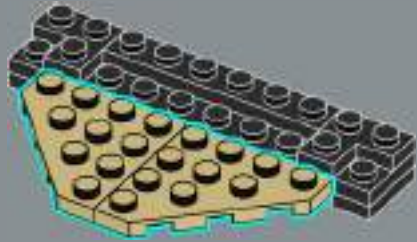

47

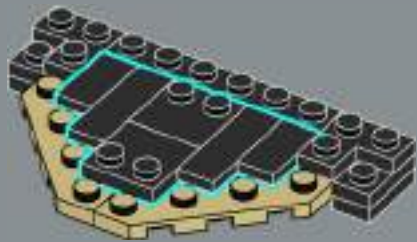

48

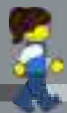
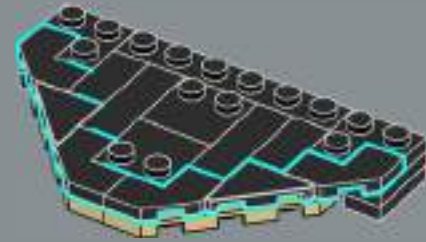

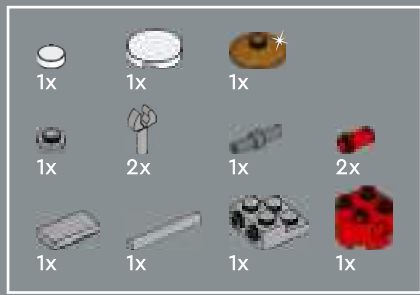

49

1



2



3

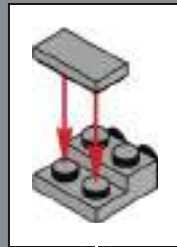

4

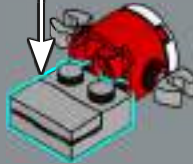

5

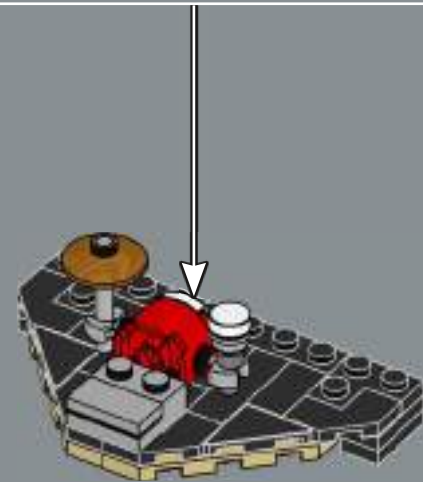
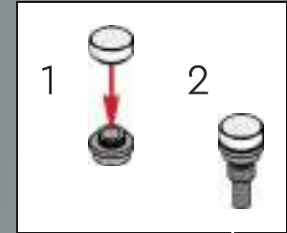



Can't you just hear the 'boom-cht' sound of the bass drum and snare, and the 'tss-t-t-tss' of the cymbal?

50

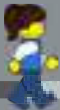
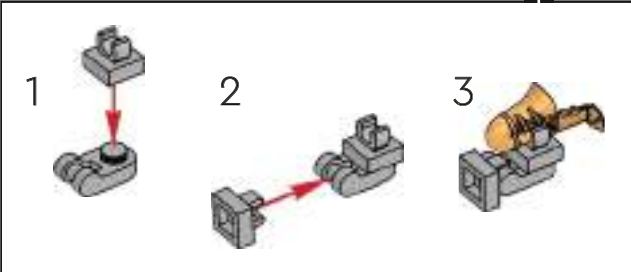
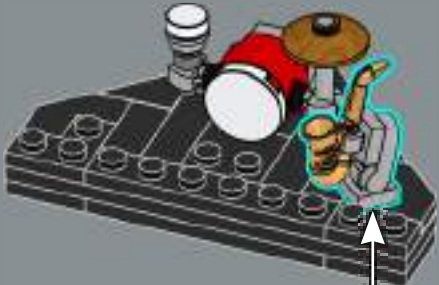

51





The pizza chef grows some of his own ingredients in the rooftop greenhouse. Others he purchases fresh at the LEGO® 10185 Green Grocer.

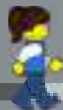
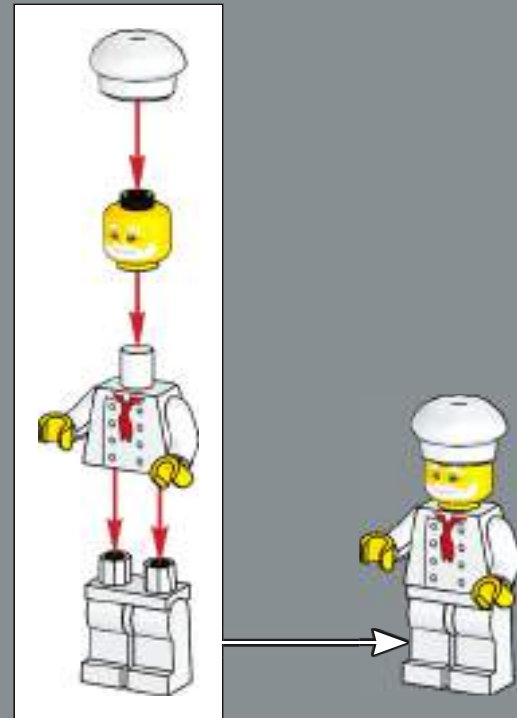



52

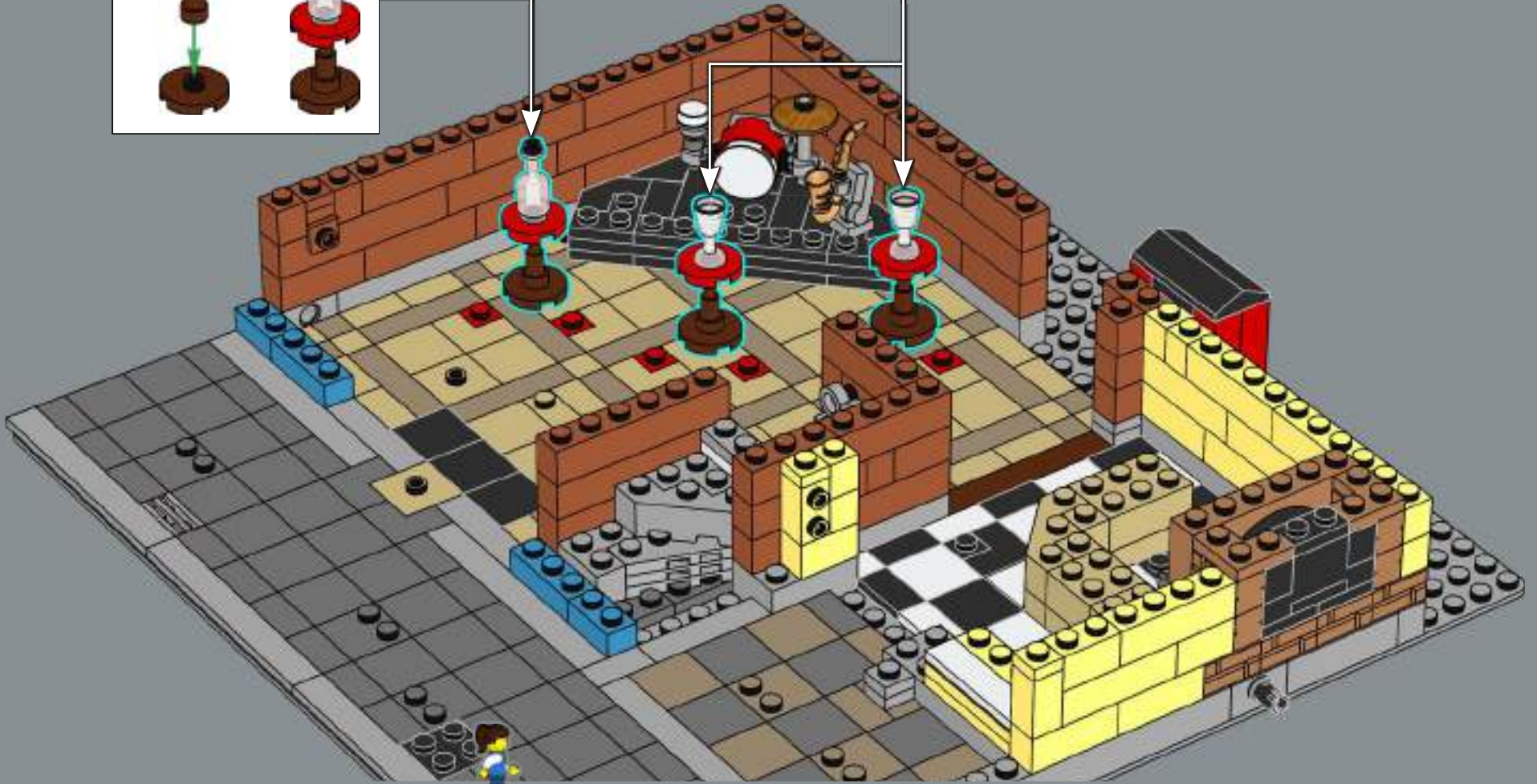
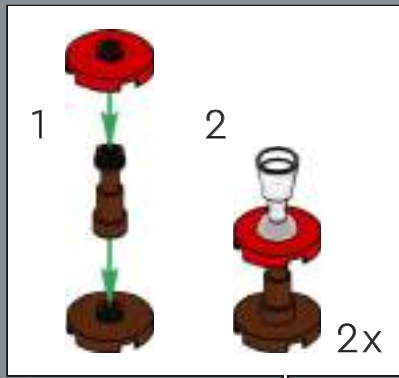
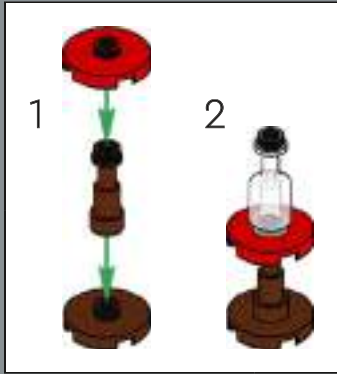

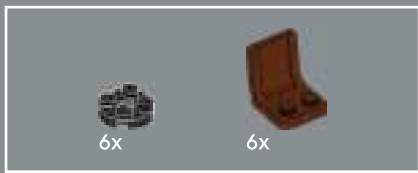

53

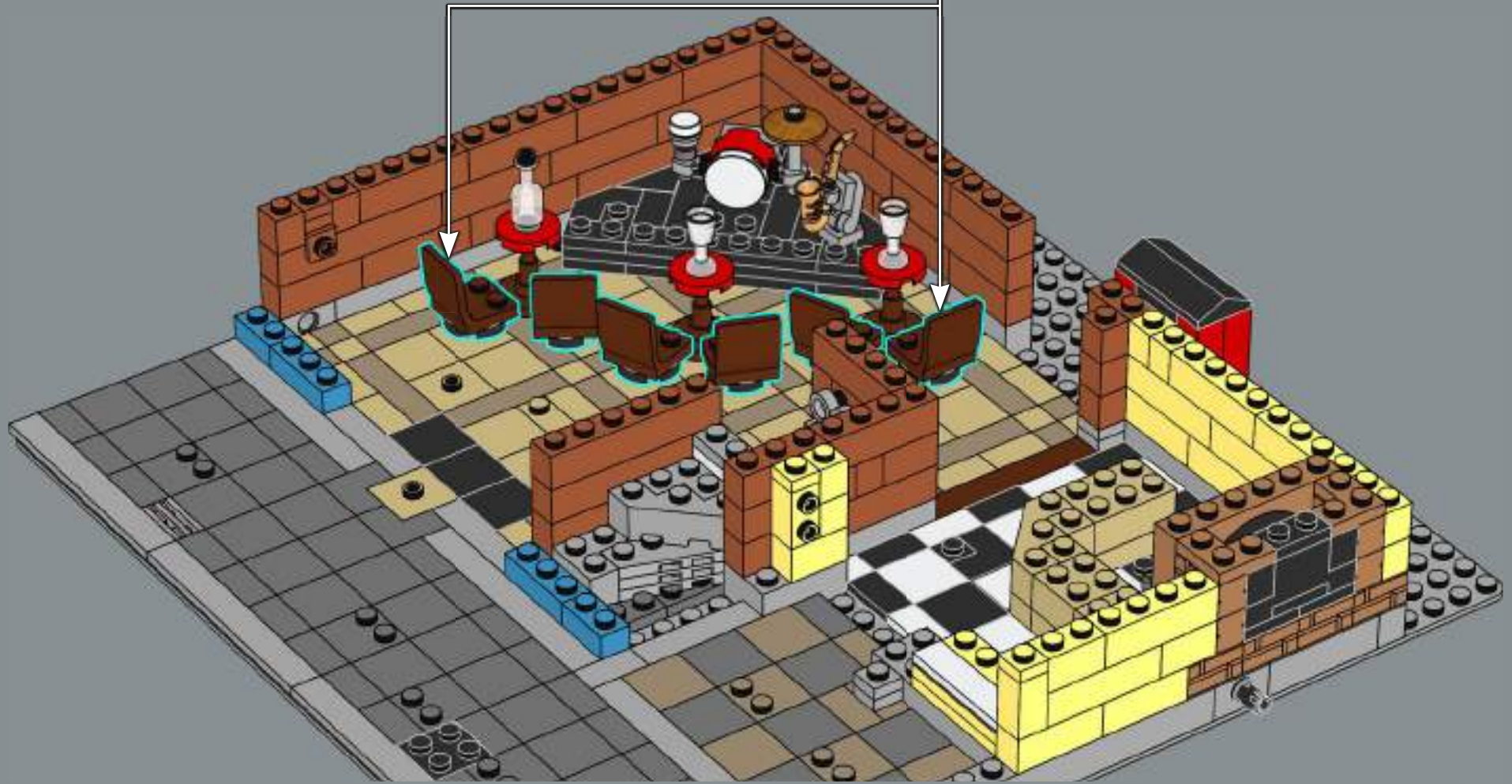
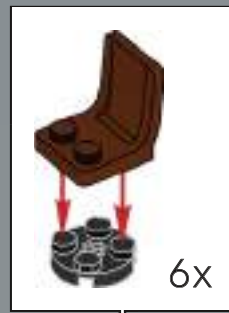

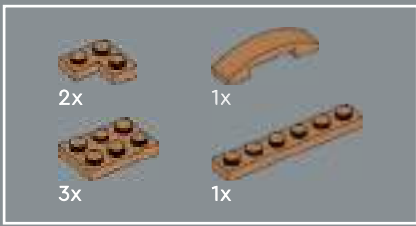

54

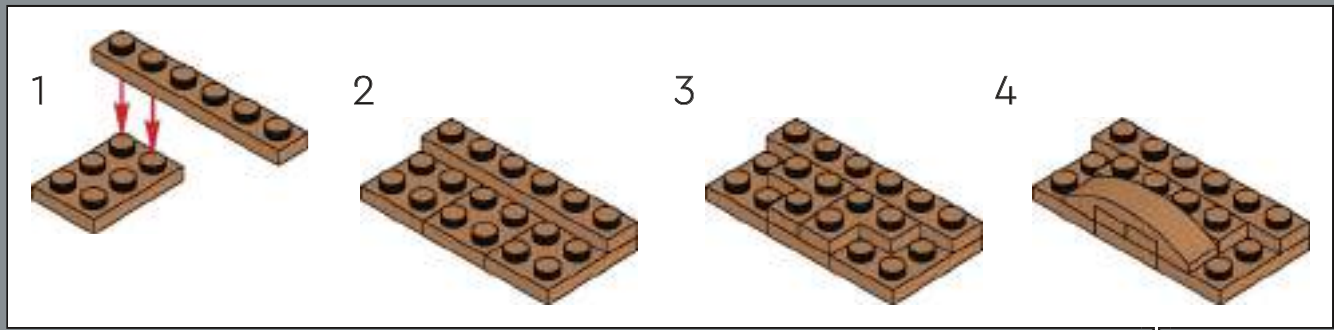

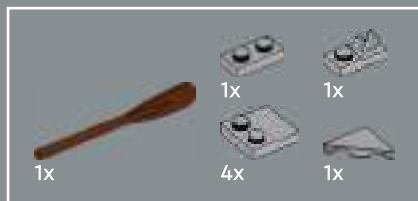

55

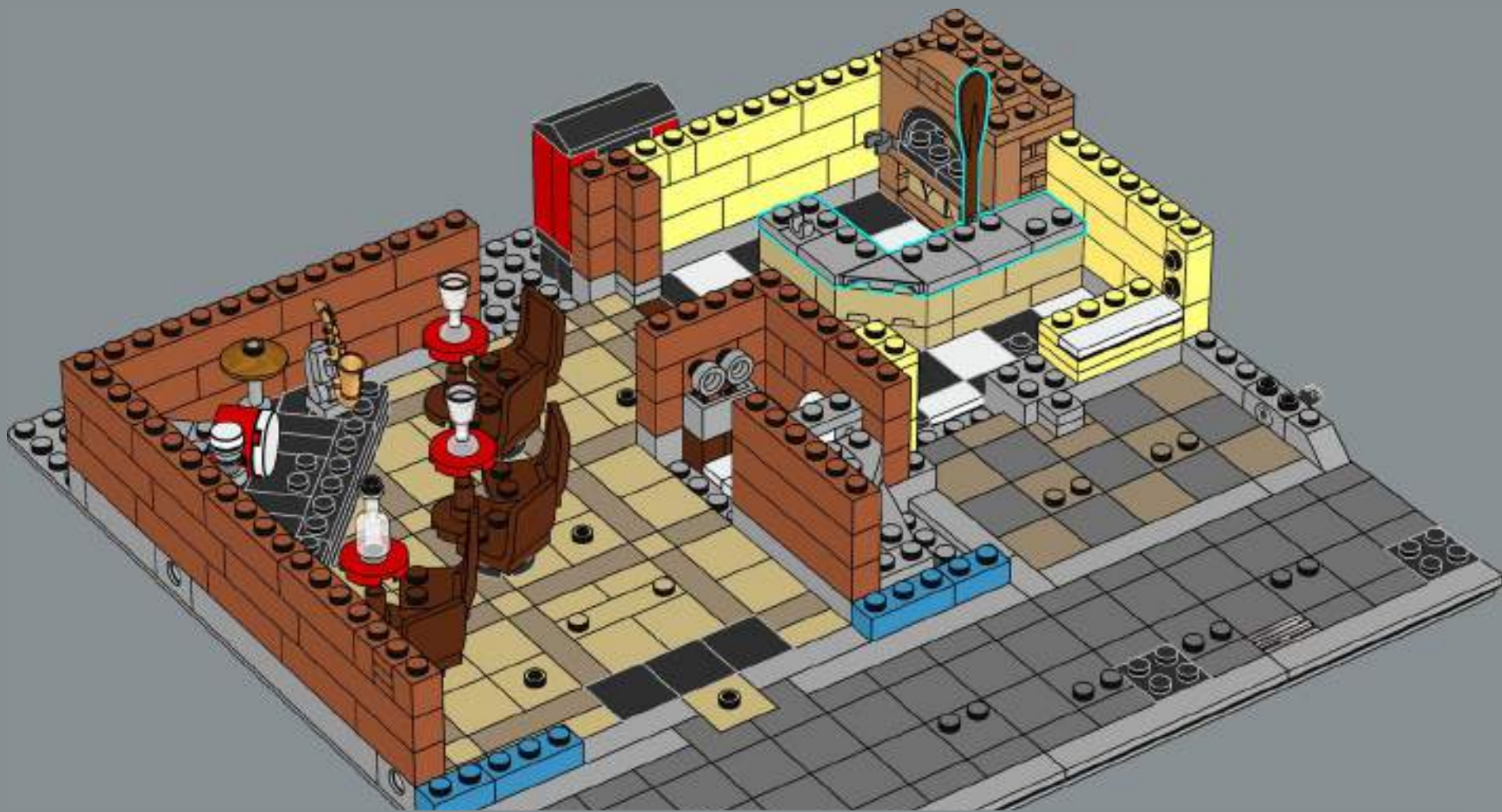



56

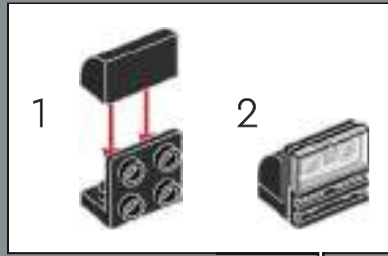



57



One delicious margherita pizza coming right up!
Customers can enjoy the whole pie or buy it by the slice.

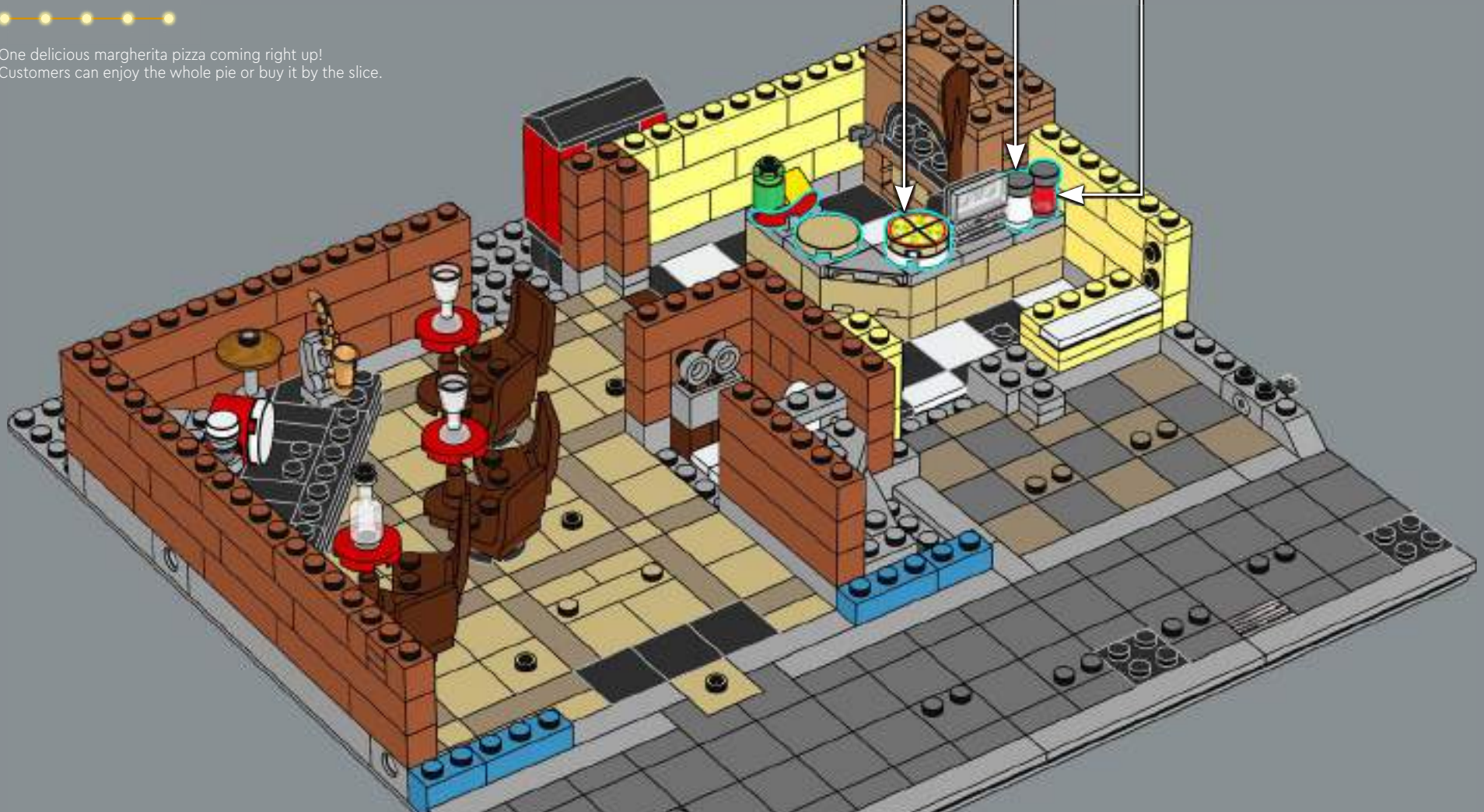
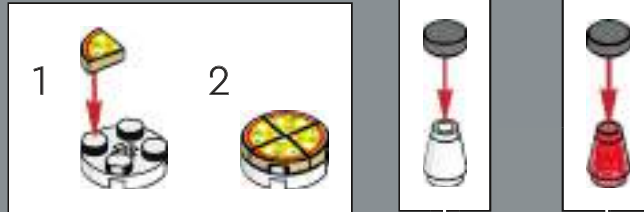

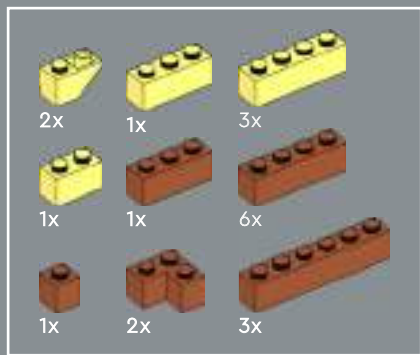

58



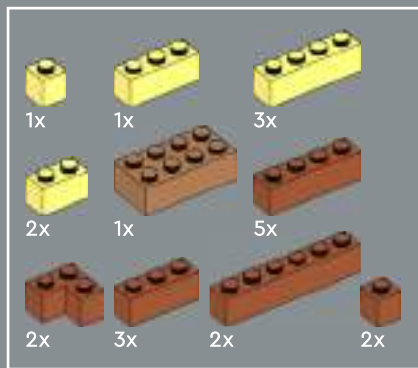

59

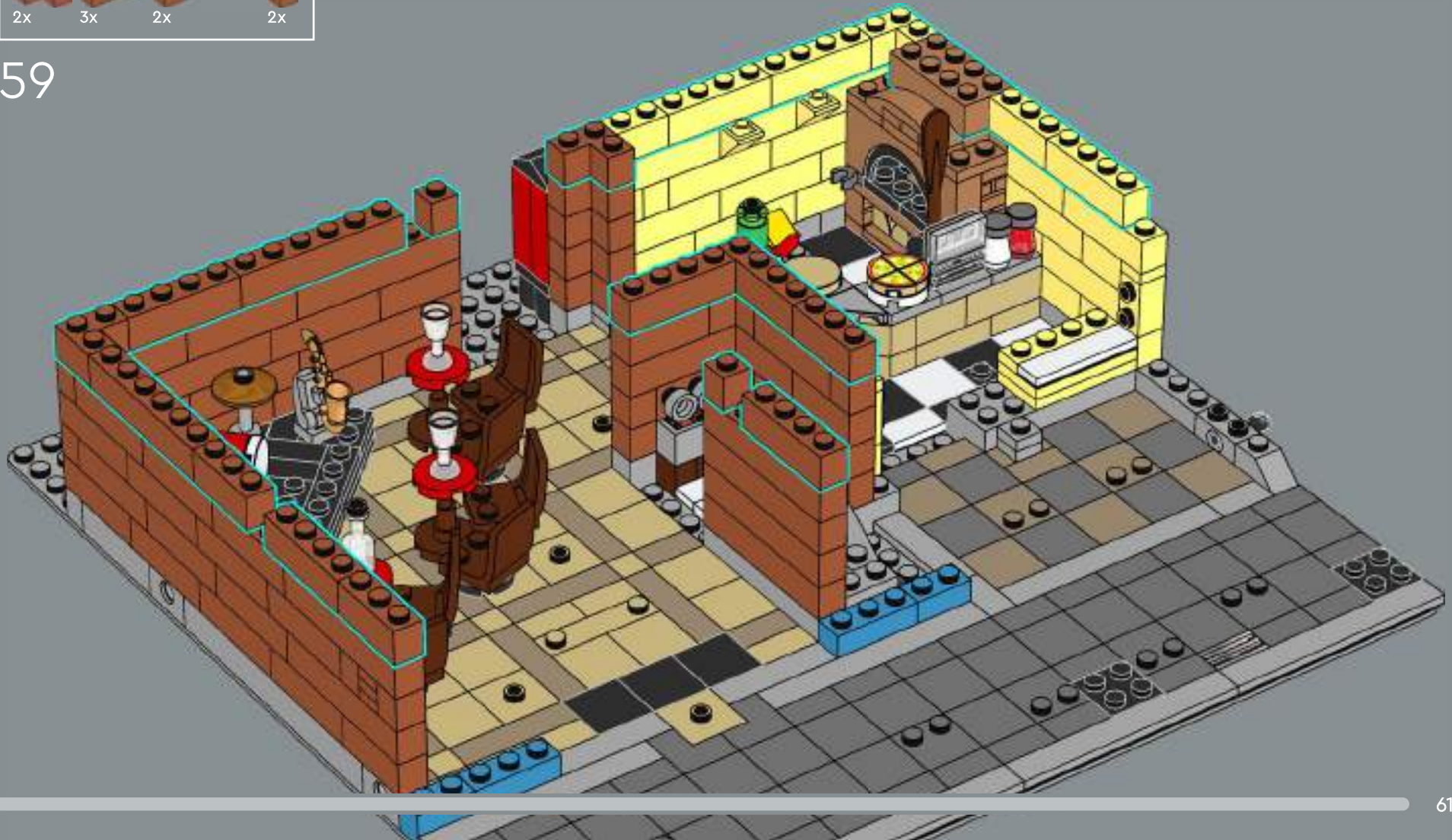



60

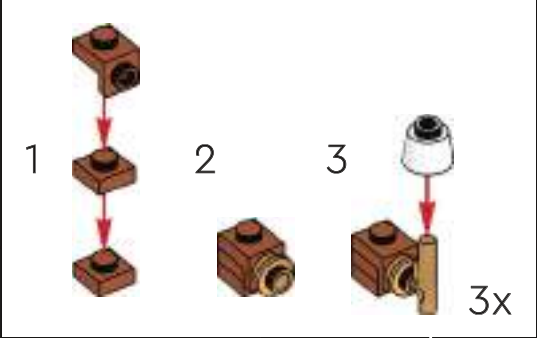

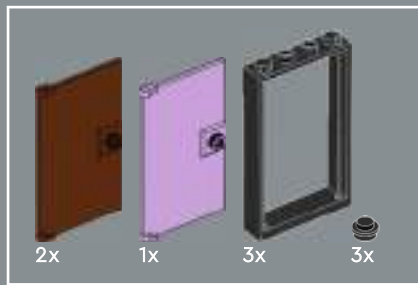

61

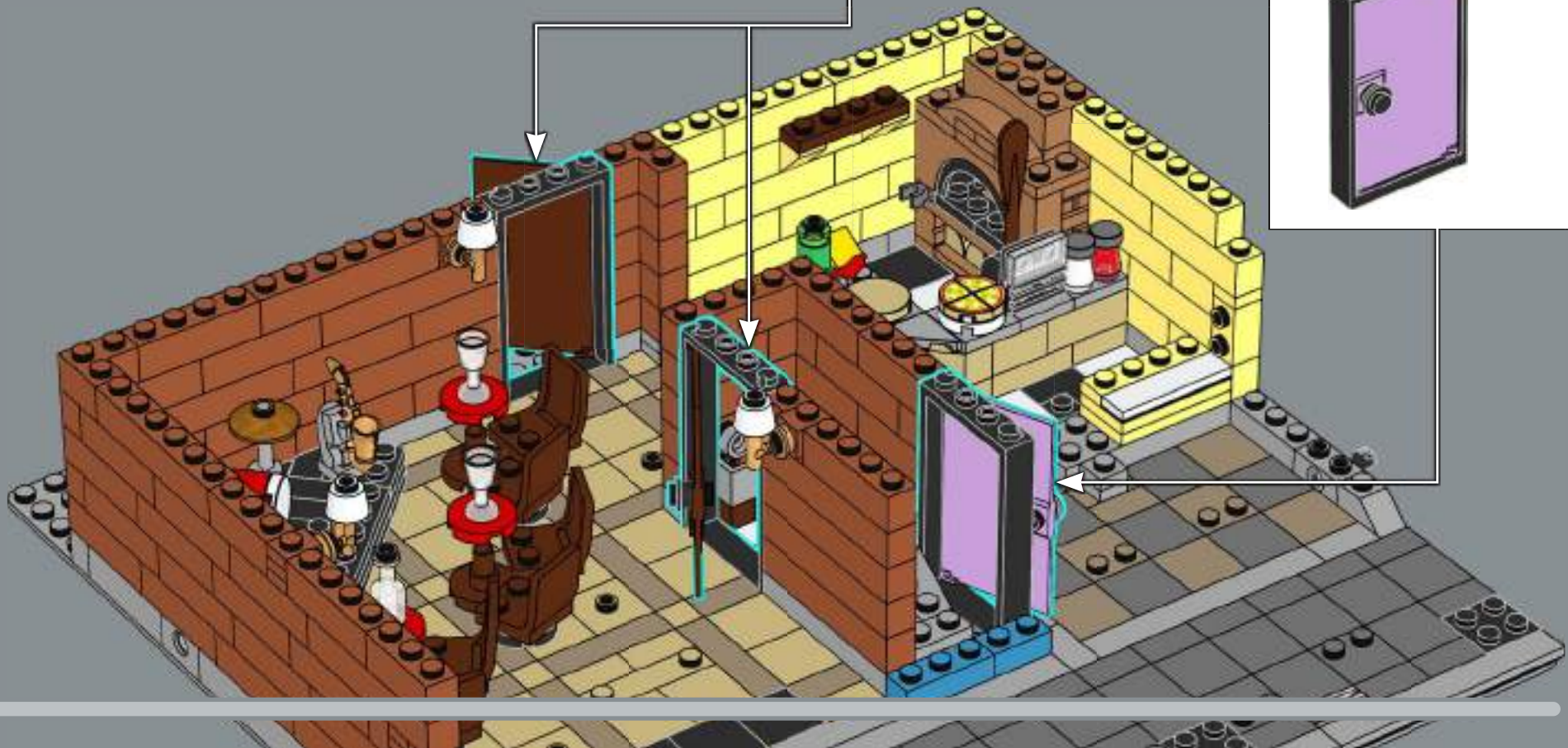
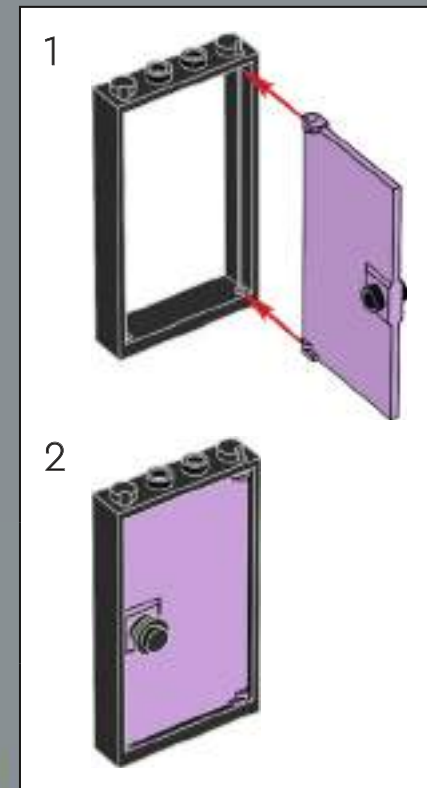
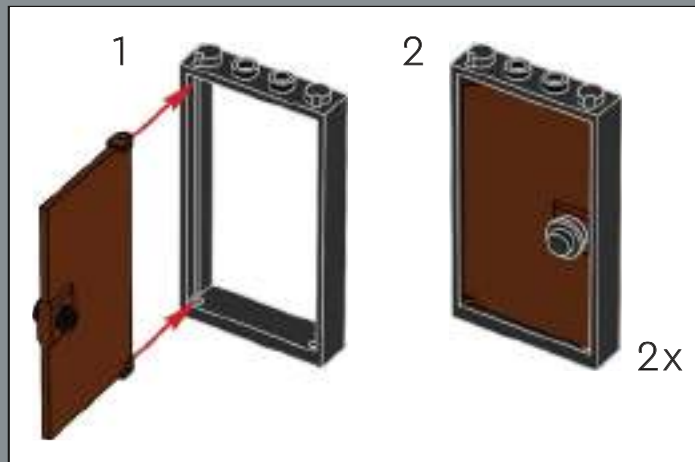



62



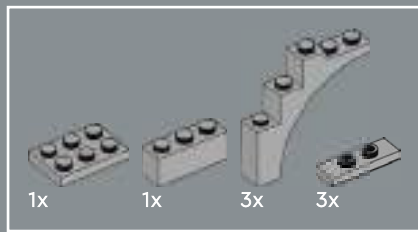

63

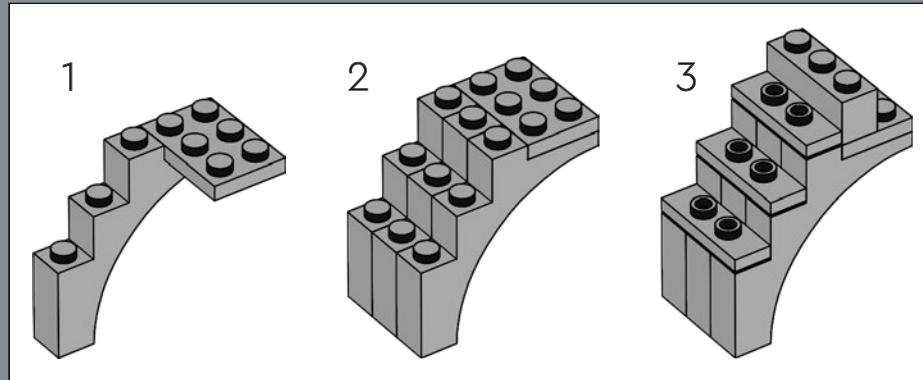

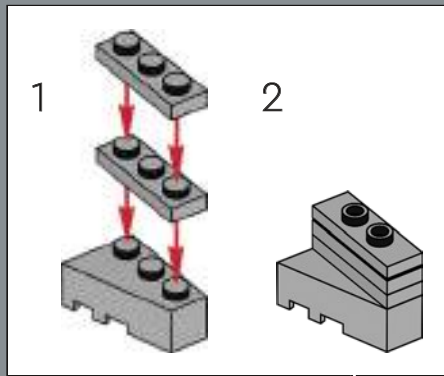
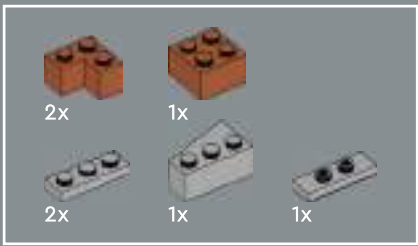

64

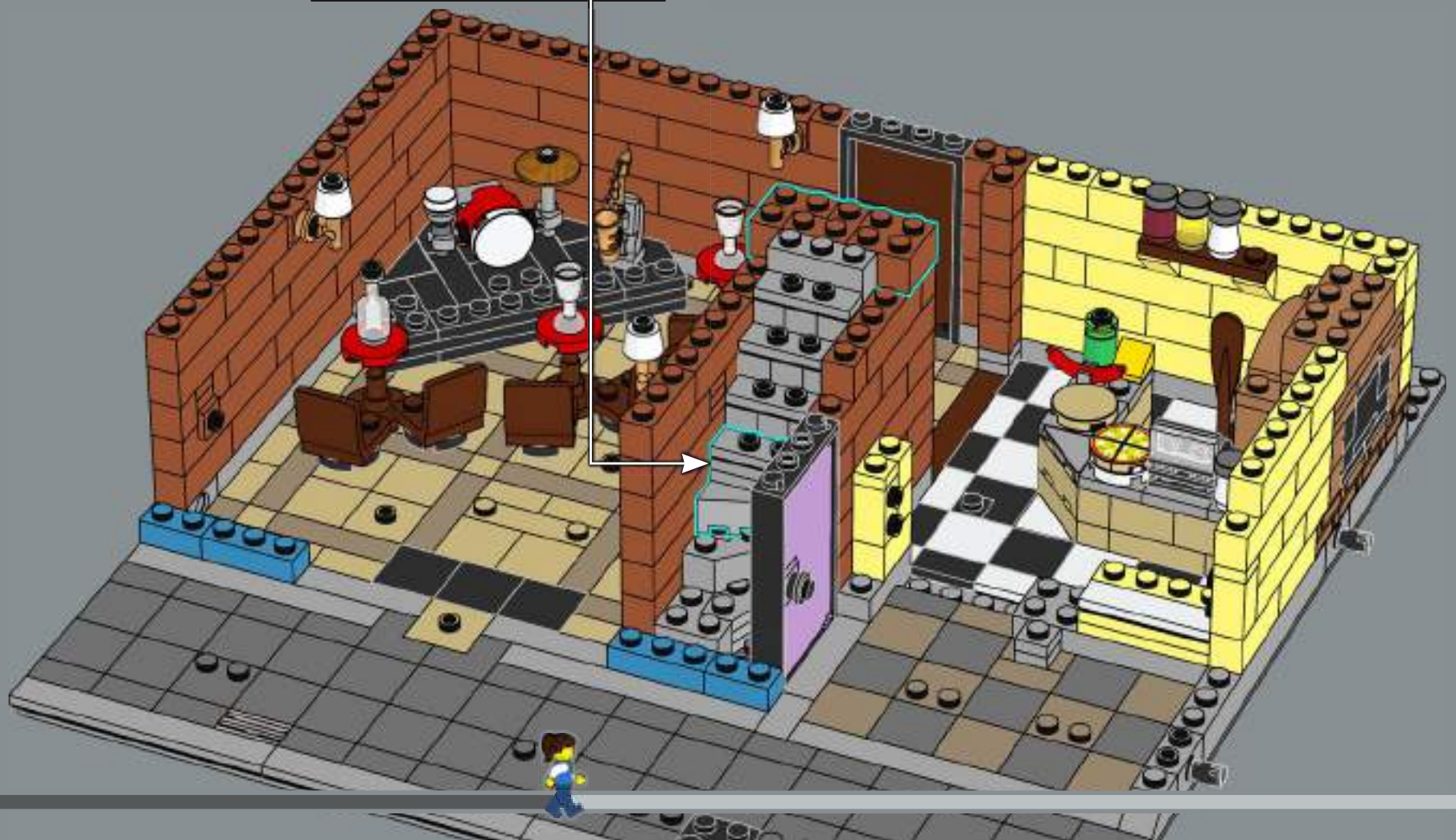



65

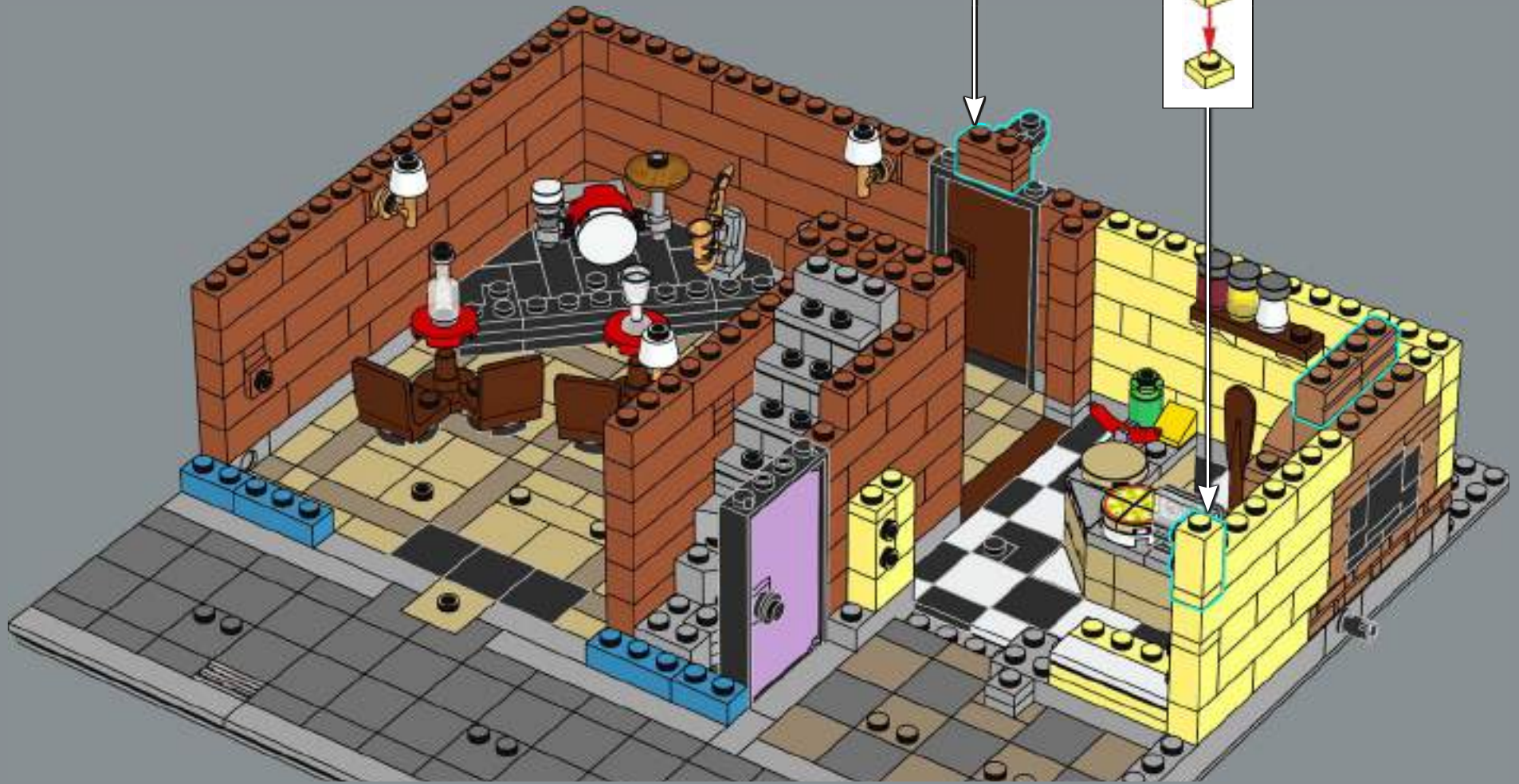
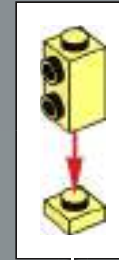
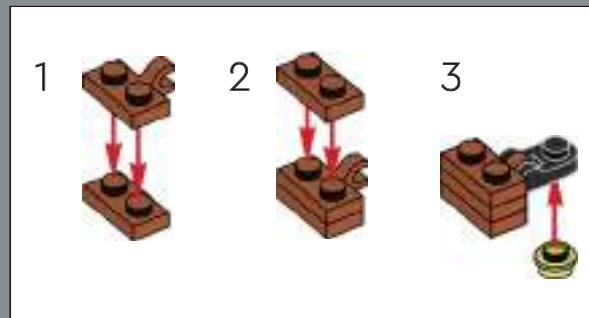

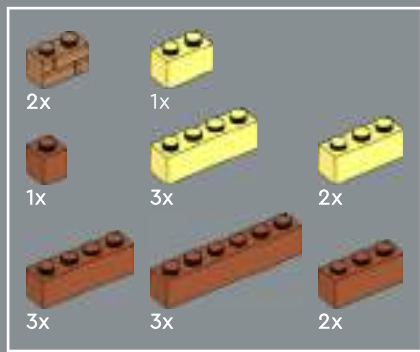

66



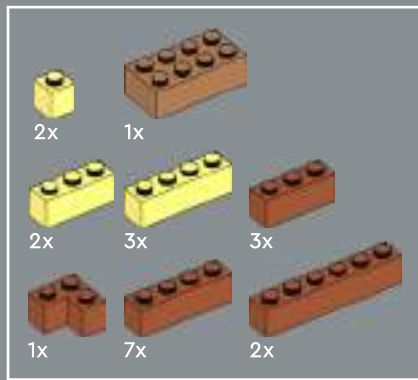

67



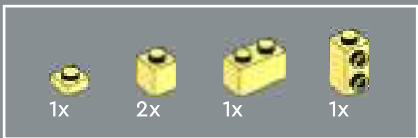

68

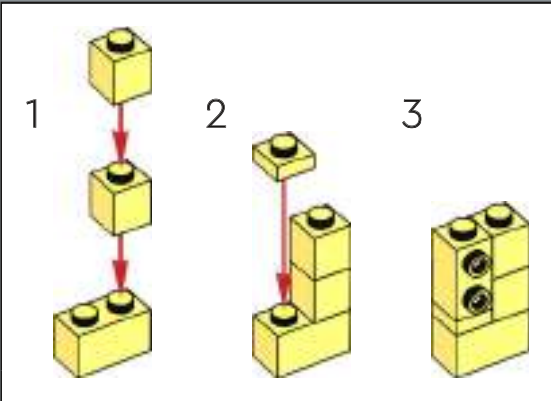

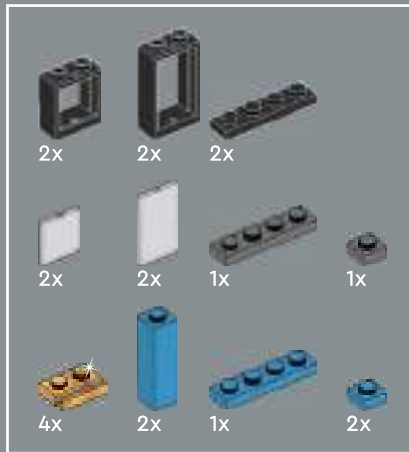

69

1



2

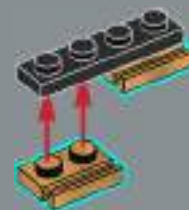

3

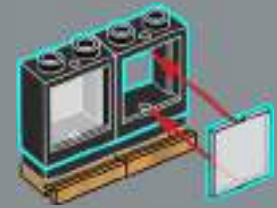

4

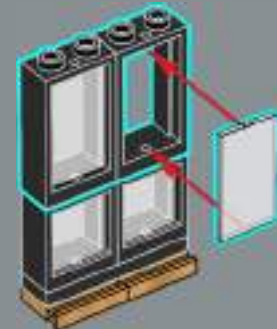

5

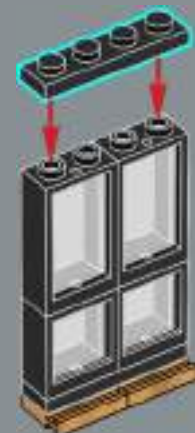

6



7

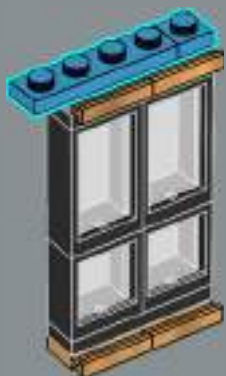

8

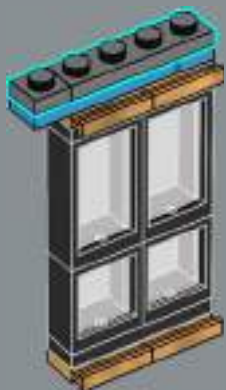

9

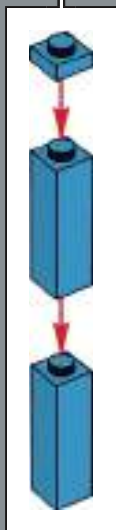
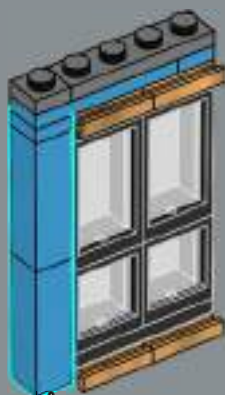

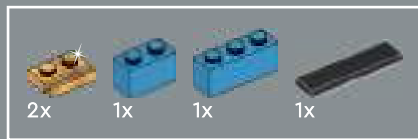

70



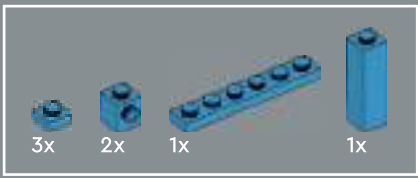

71

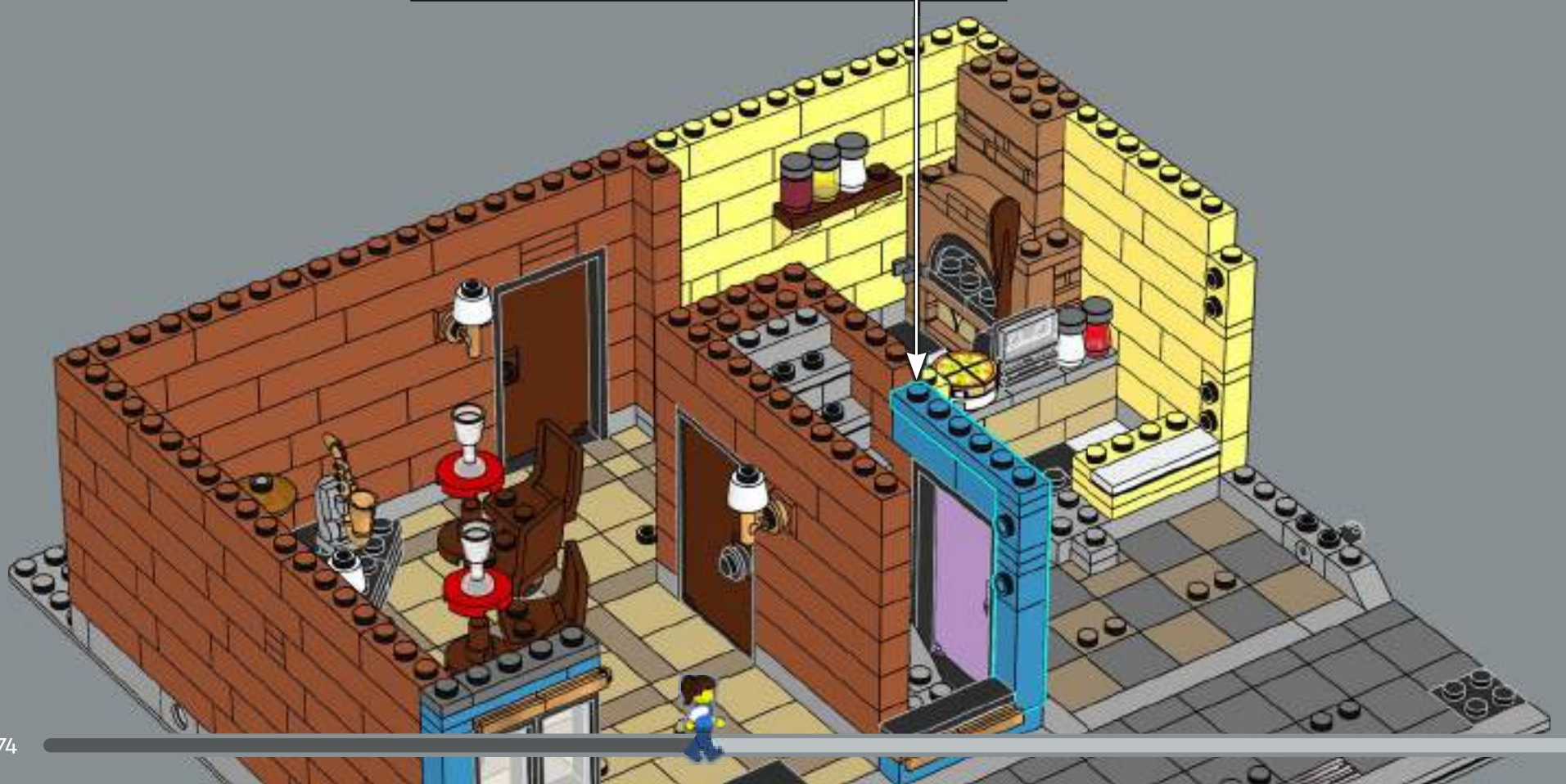
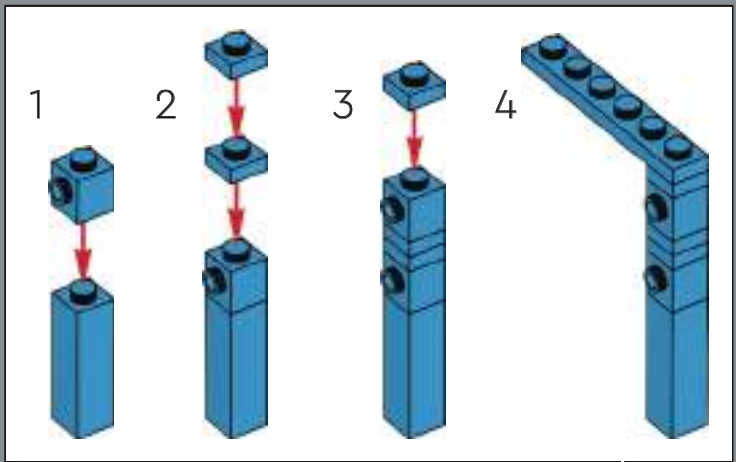



72

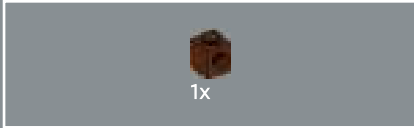
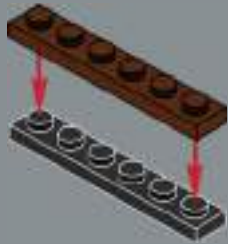

73

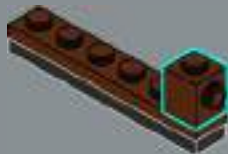

74

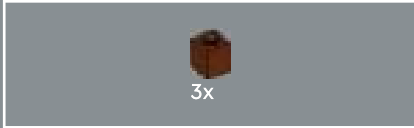

75



76

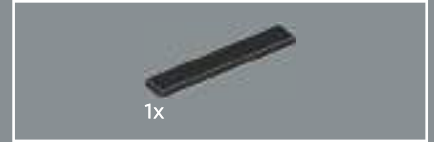

77





78

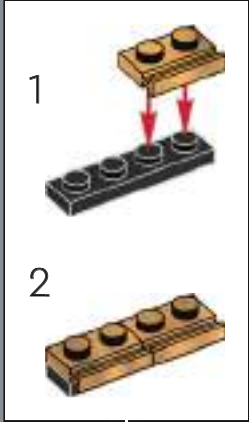

79





80



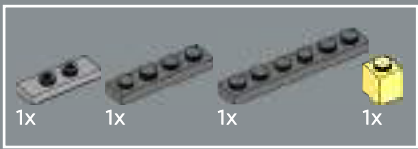

81



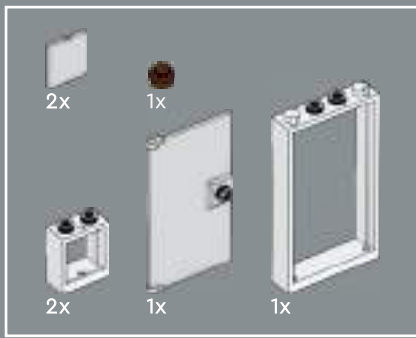

82

1

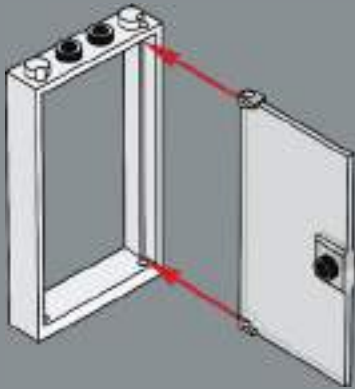

2



3



4

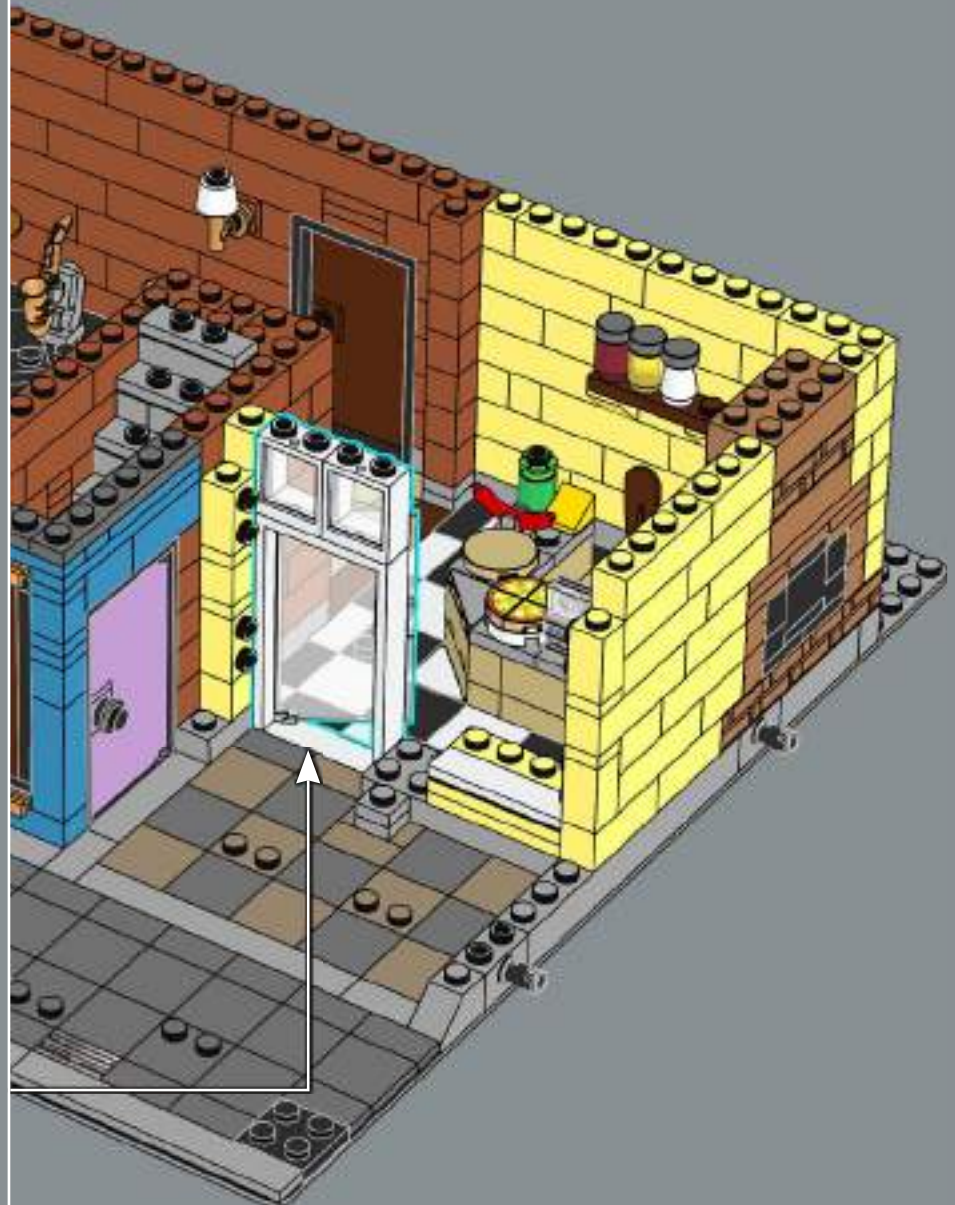
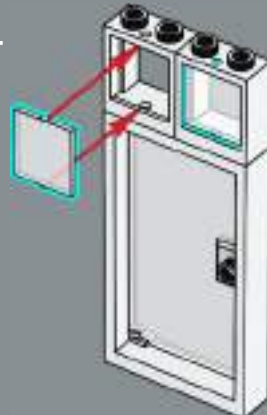

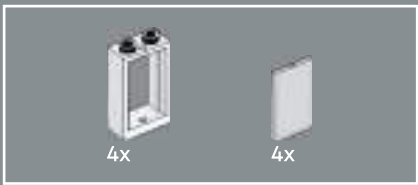

83

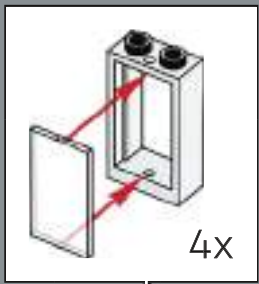



84

1

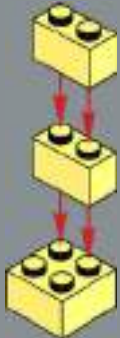

2



3



4



5

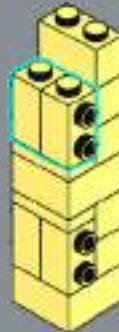

6





3x

85





86

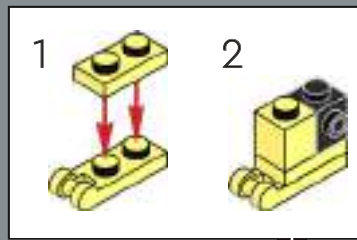

2

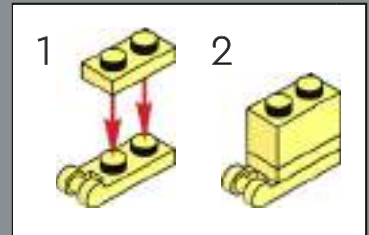
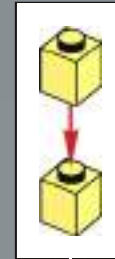
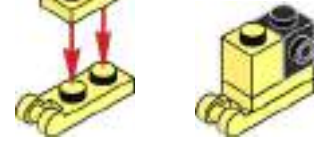

2

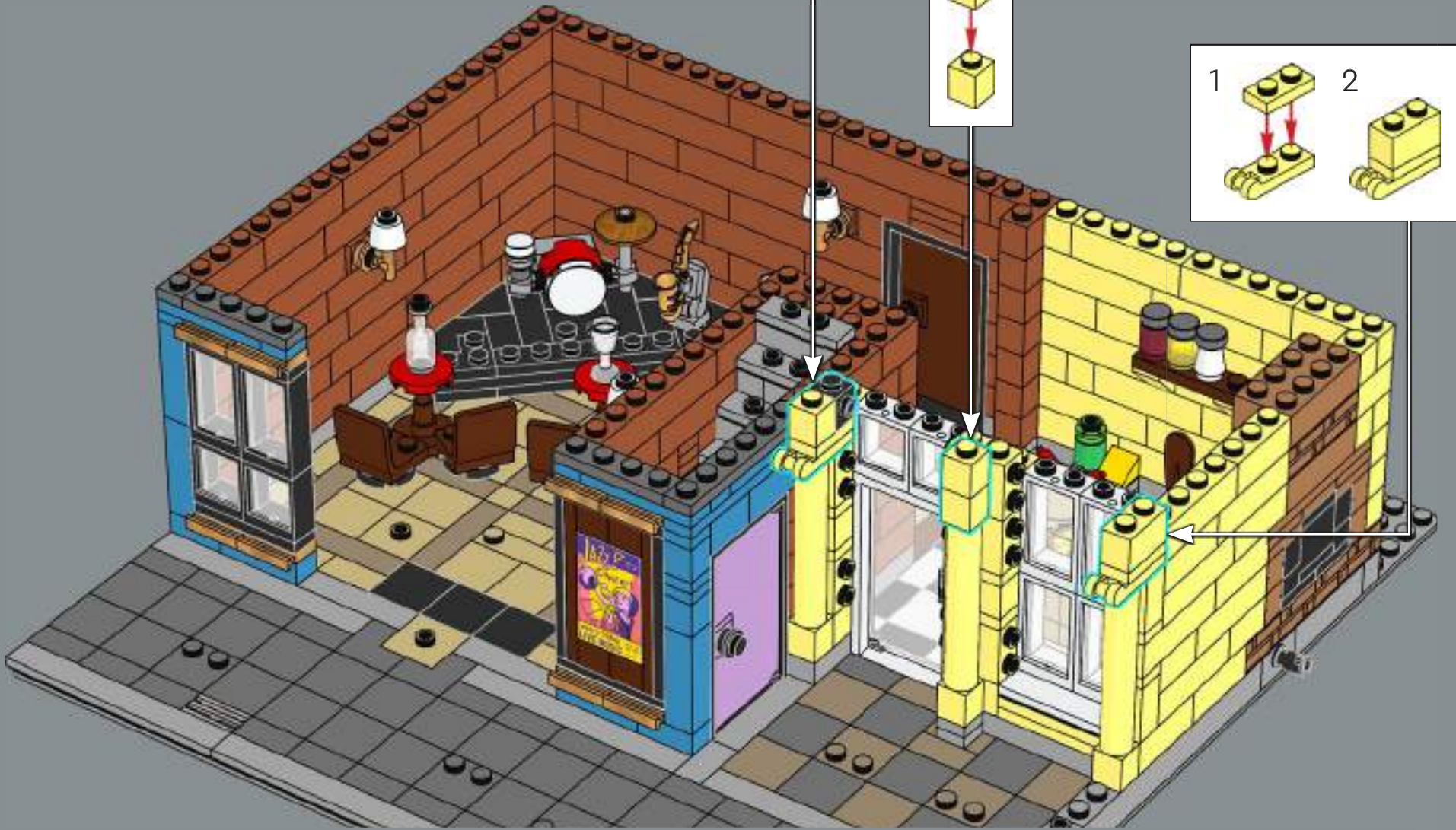
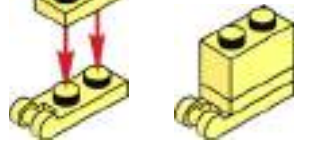



87

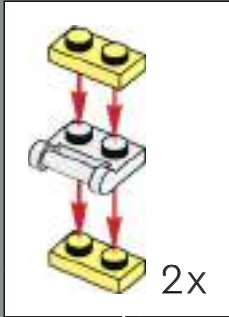

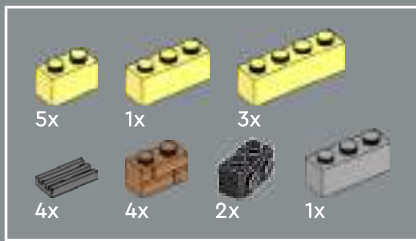

Add in these ventilation units to keep things cool.
The oven, and the music, can get pretty hot!

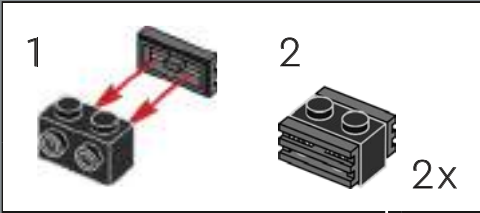

88



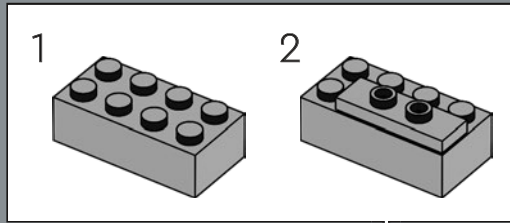
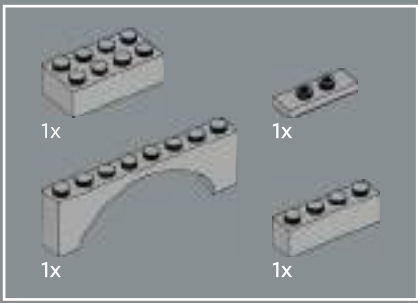

89



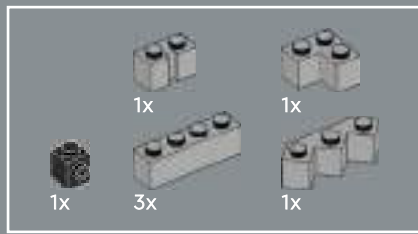

90



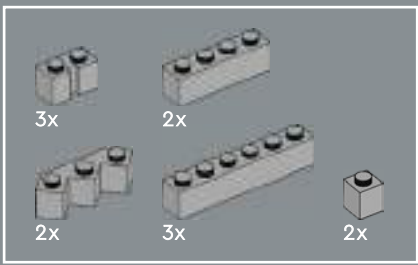

91



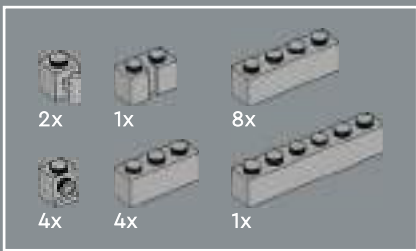

93





94

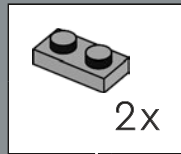

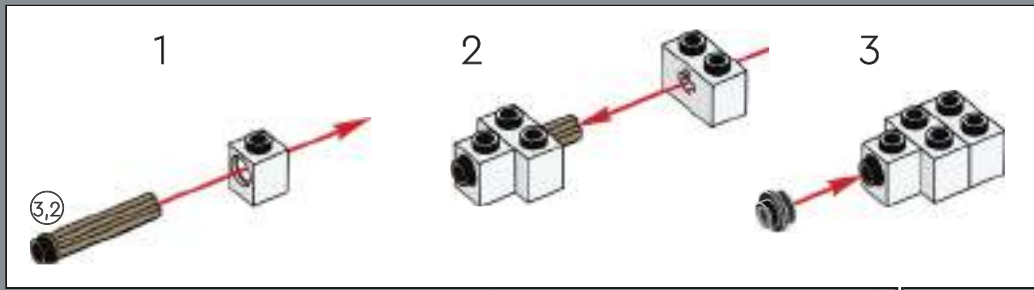
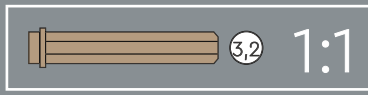

95



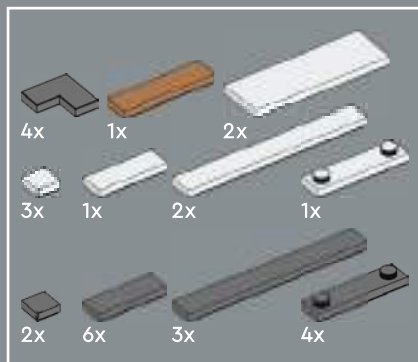

96



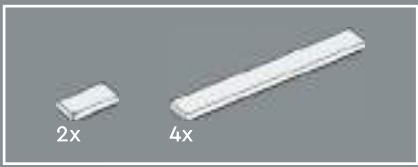

97





98

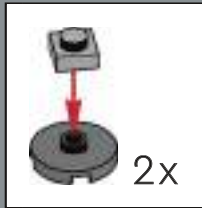
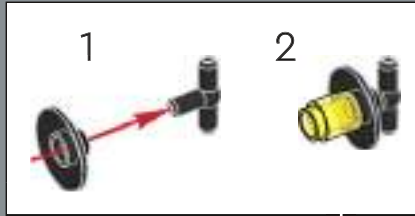

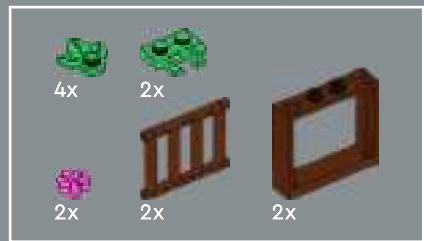

99

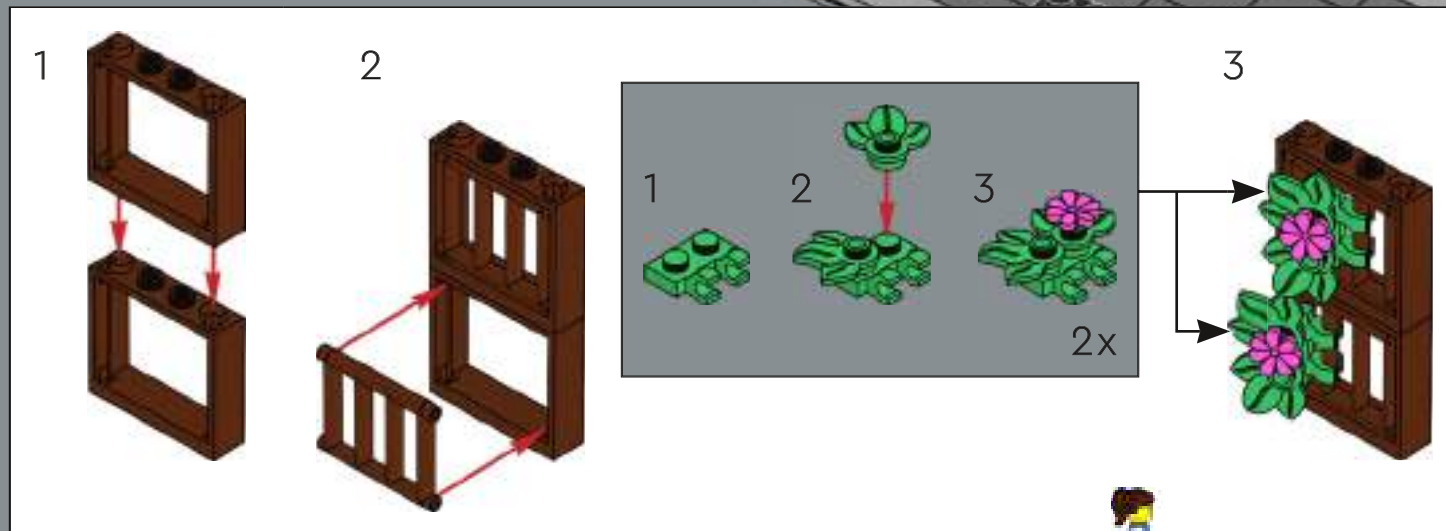

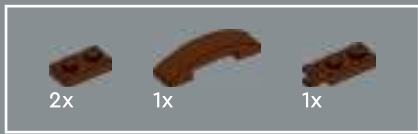

100

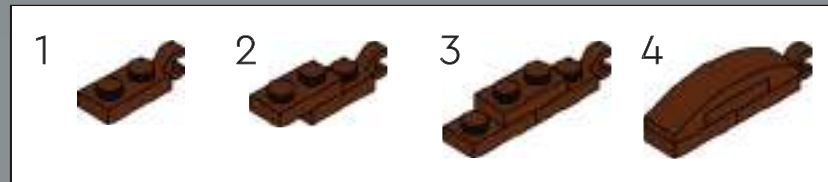



101



102

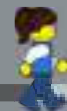



103

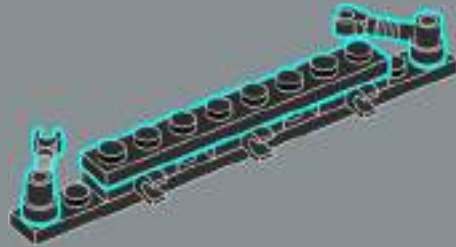

104

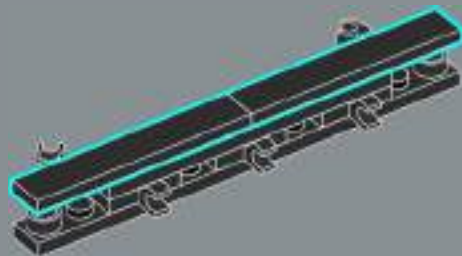

105

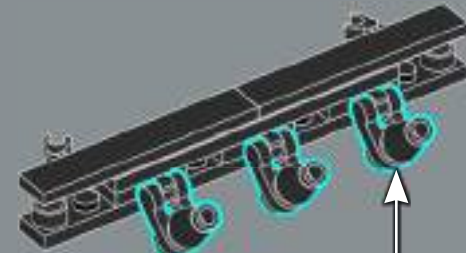

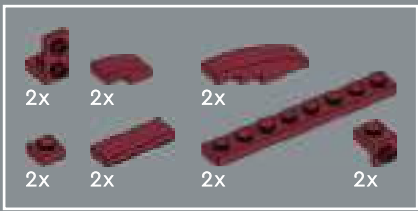

106

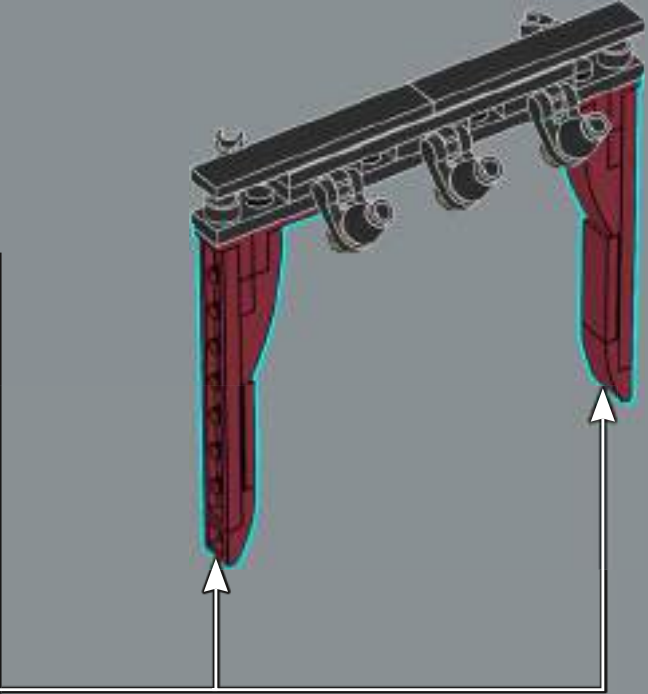
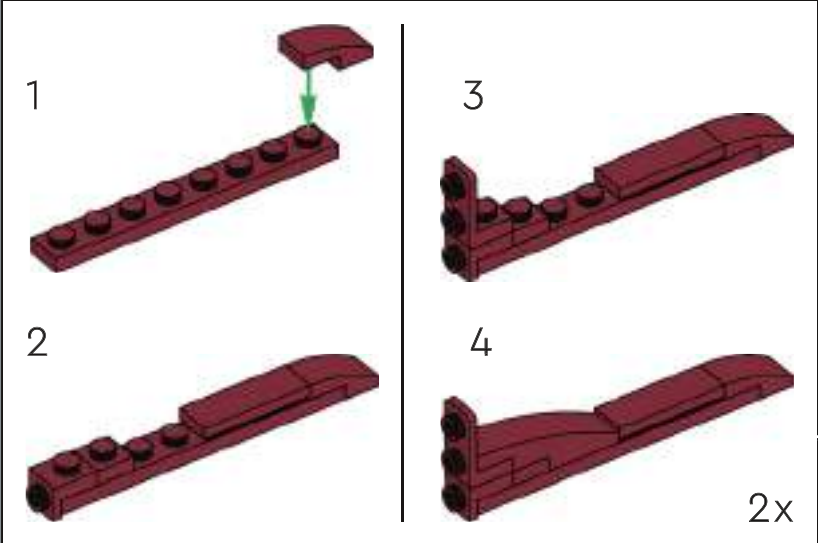



The curtains and lighting rig are designed to be easily taken out and put back in for when you want to reset the stage.

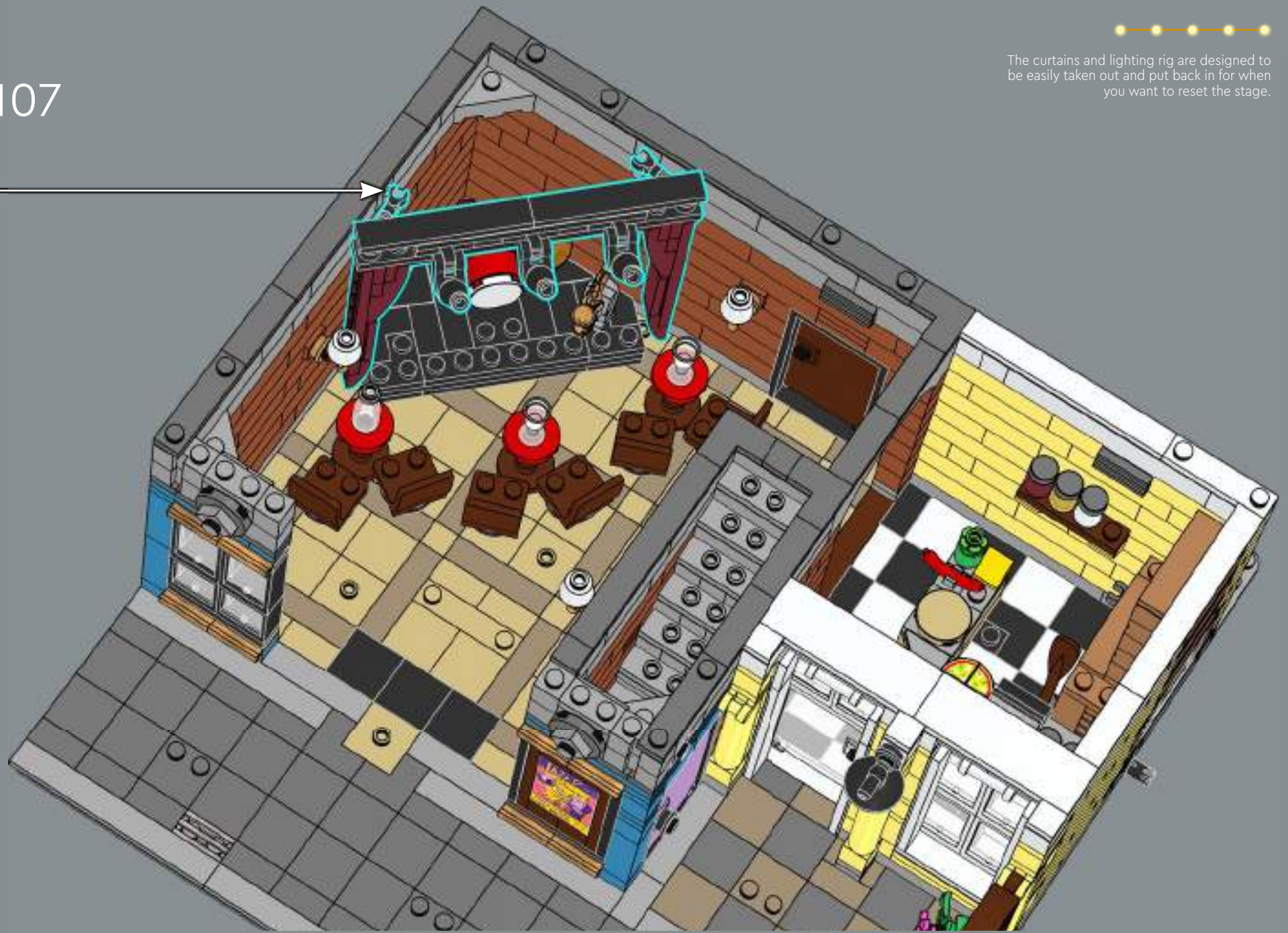

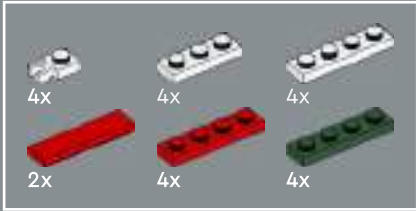

108

1

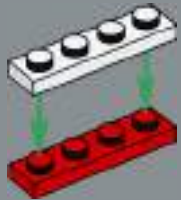

2

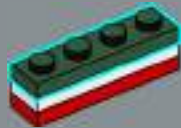

3

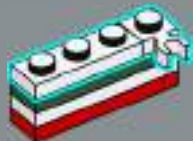

4



5



6



7



2x





109



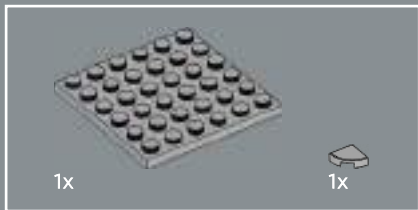

110

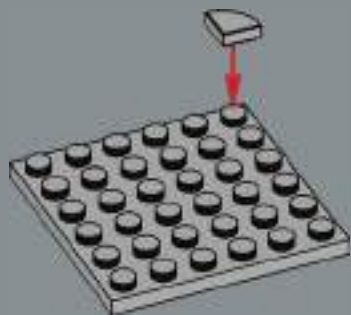

111

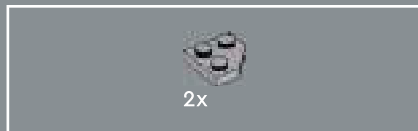

112

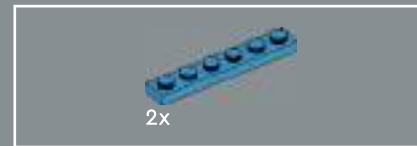
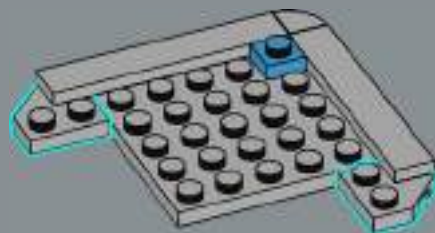

113

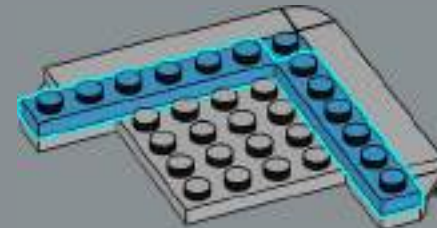

114

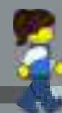
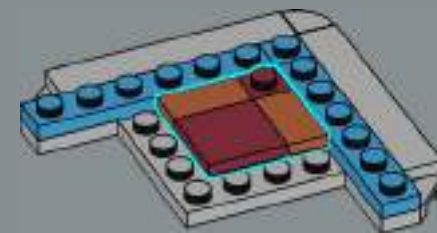



115

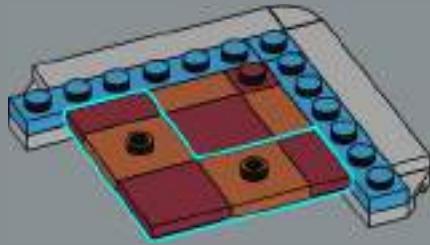

116

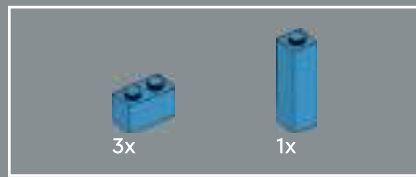
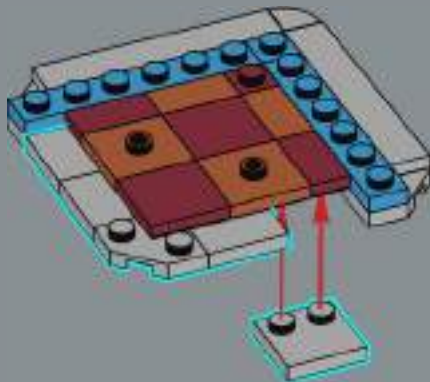

117

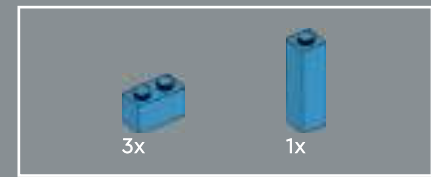
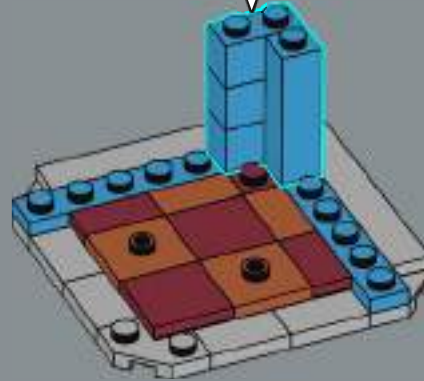
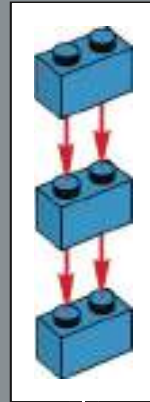

118

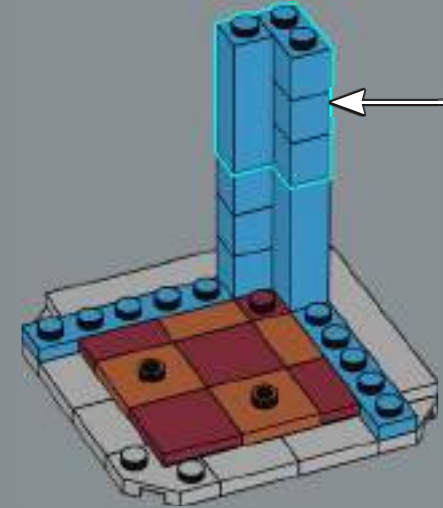
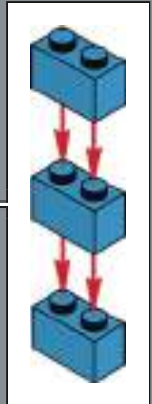



119

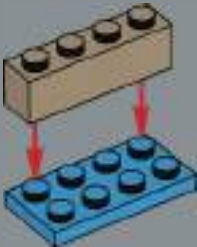

120

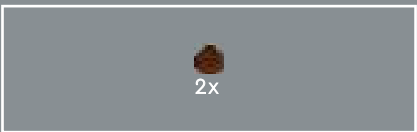
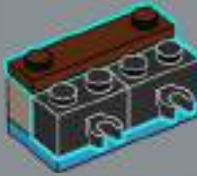

121

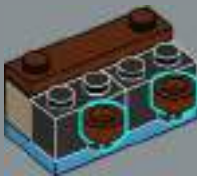

122

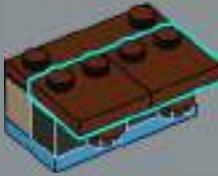

123

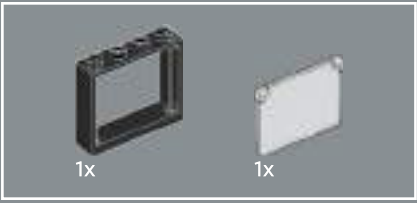

124

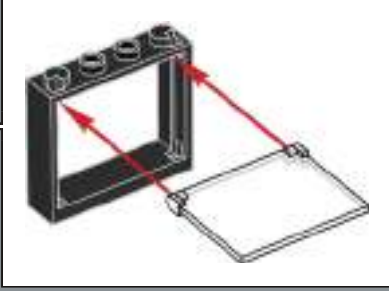



125

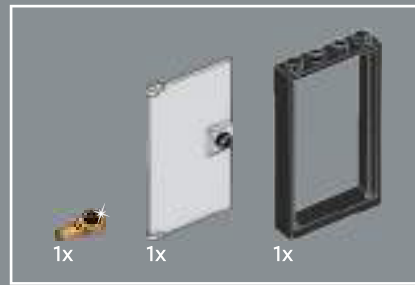

127

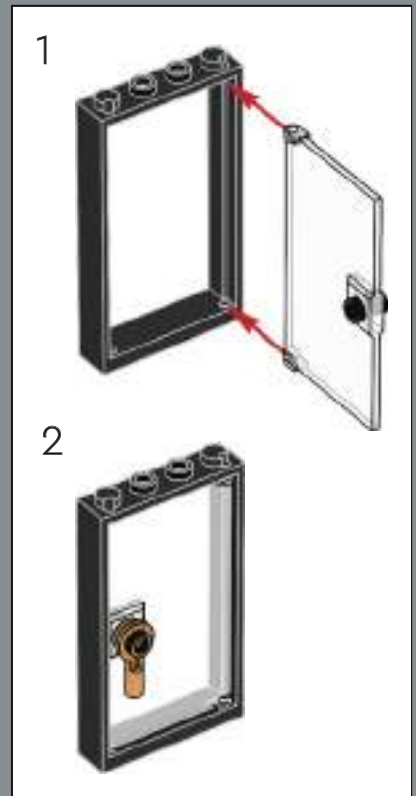

126

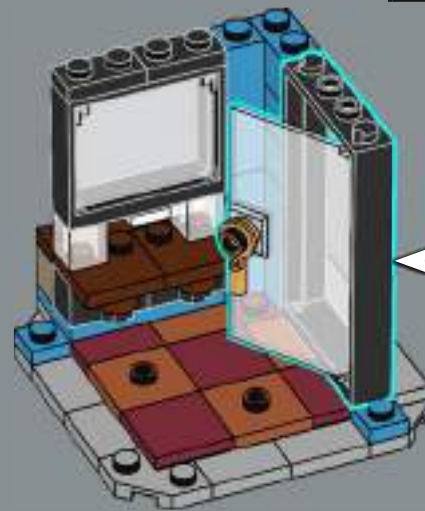
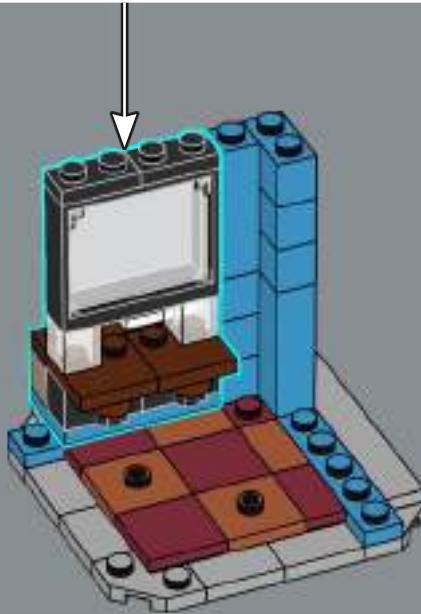



4x

128

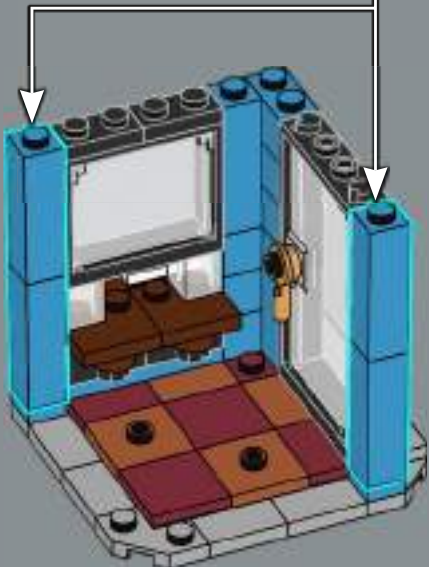
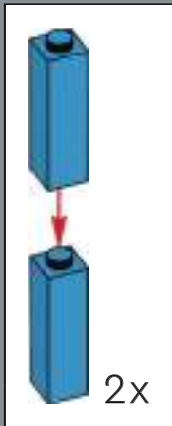

4x



2x

129

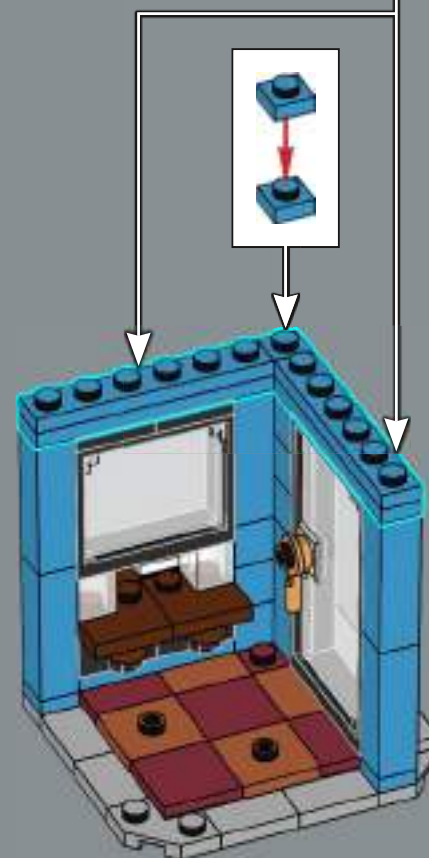
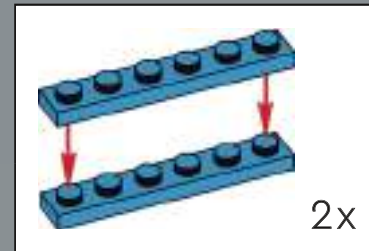



130



131

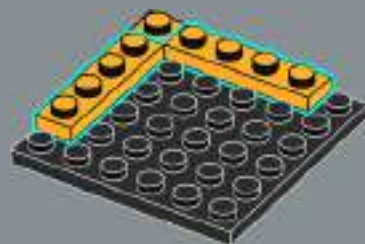

132

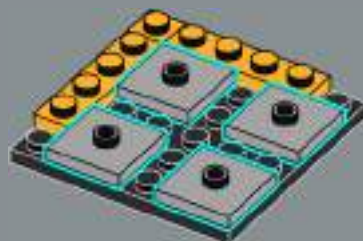

133

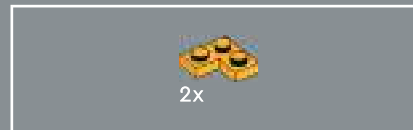
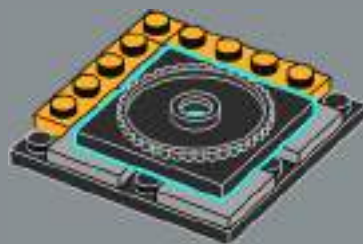

134



135





136

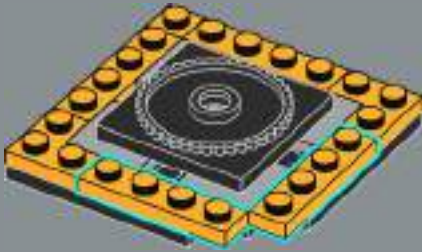

137

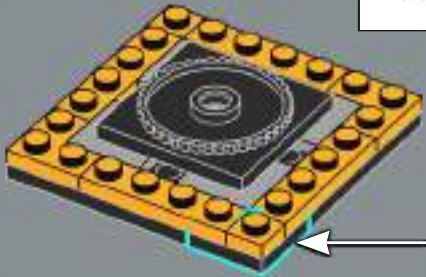
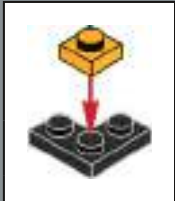

138

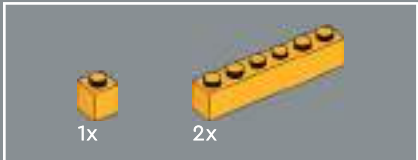
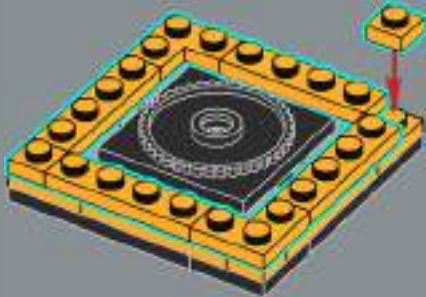

139

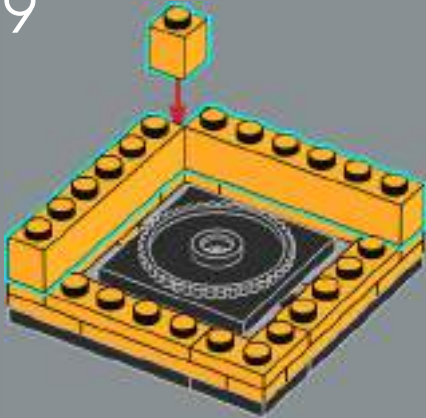

140



141

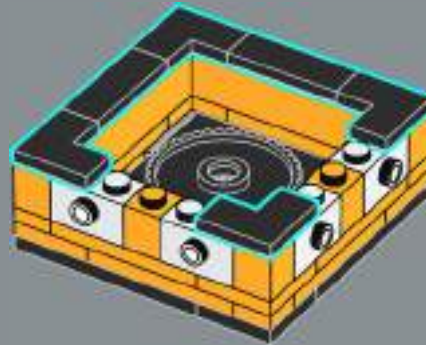



142

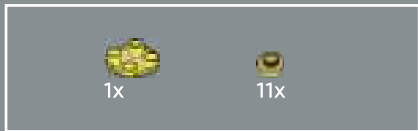
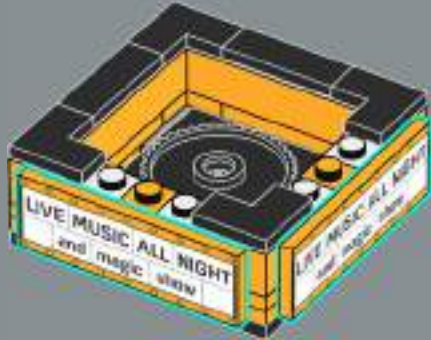

143

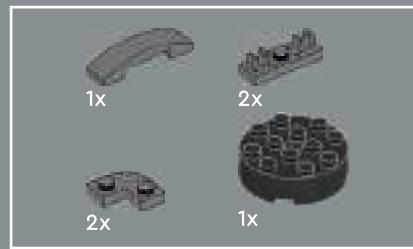

144

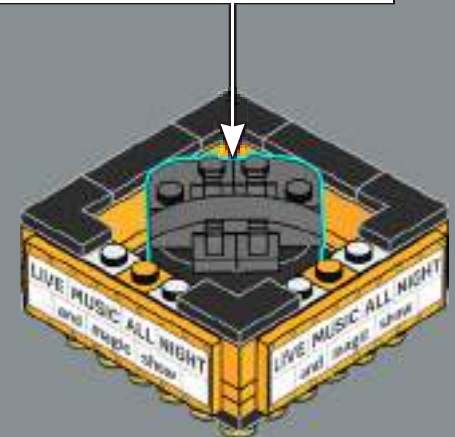
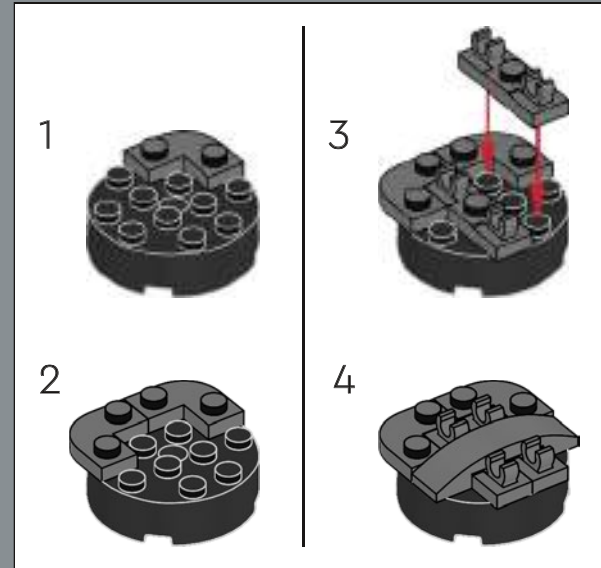



145

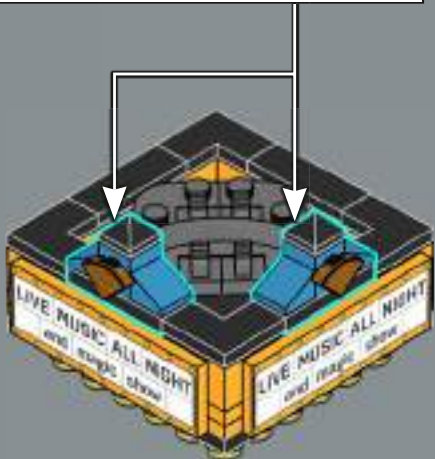

146



The Jazz Club not only supports music but all kinds of performing arts as well. Stay late enough and see what new tricks the local magician has up her sleeve.

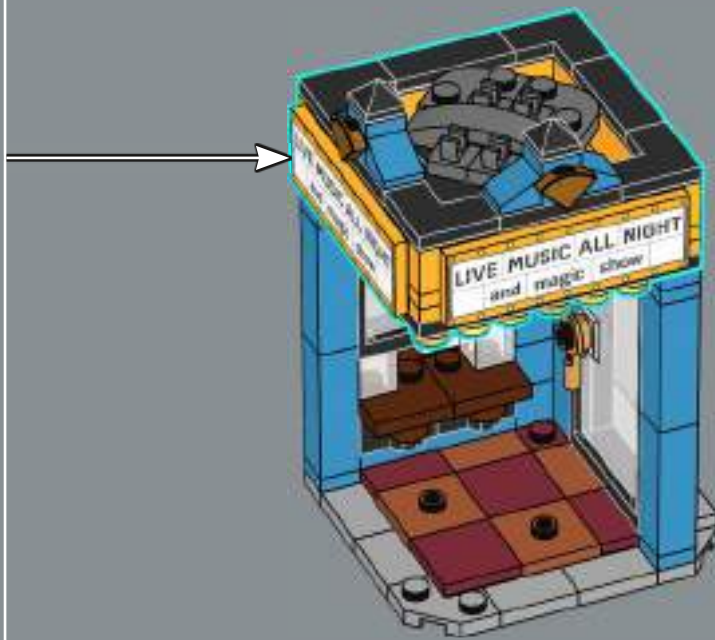



147

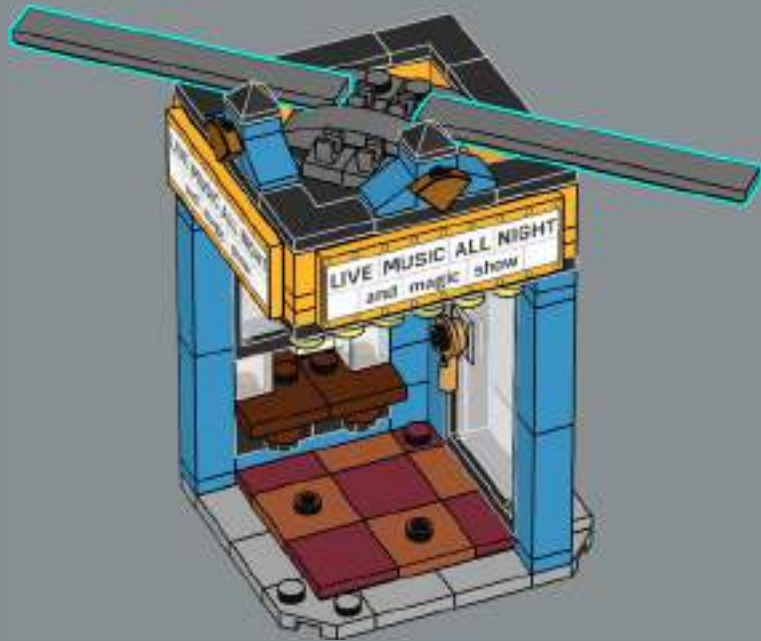

148



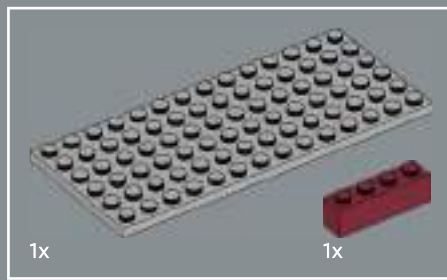

149

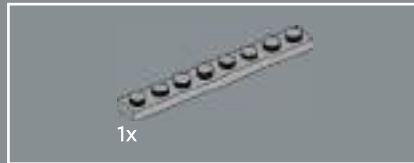
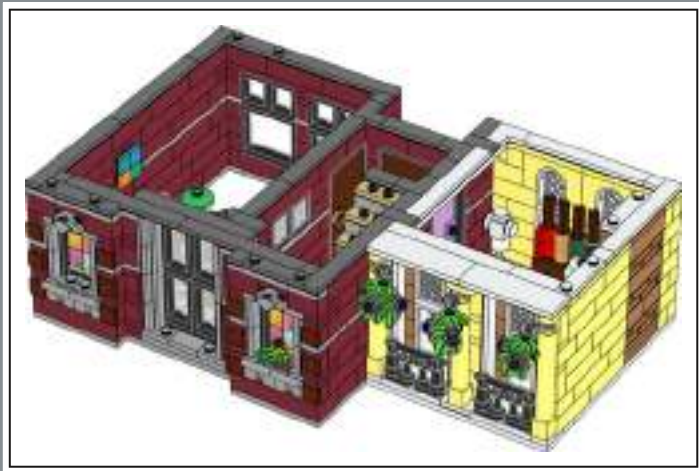
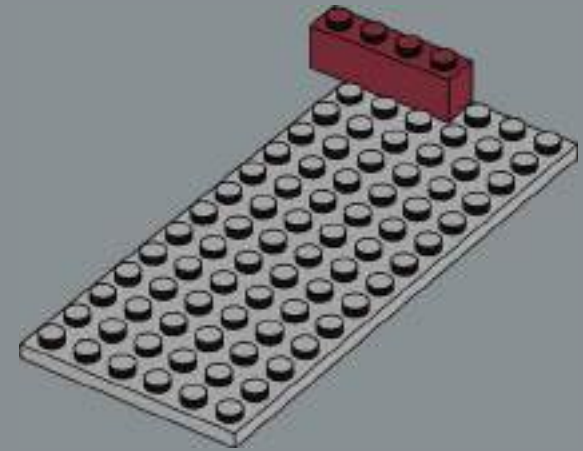

150

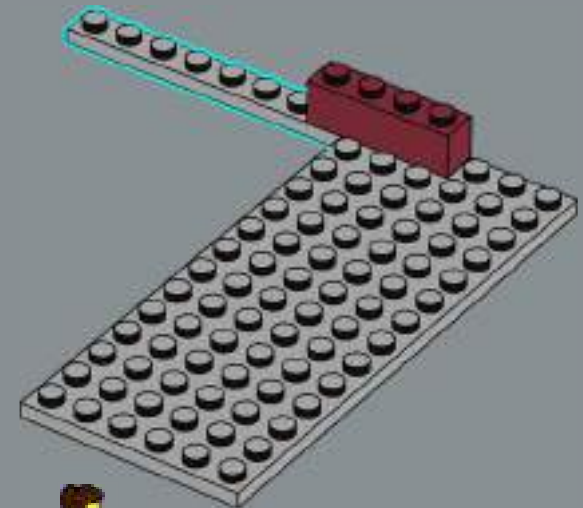



151

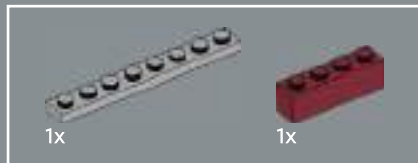
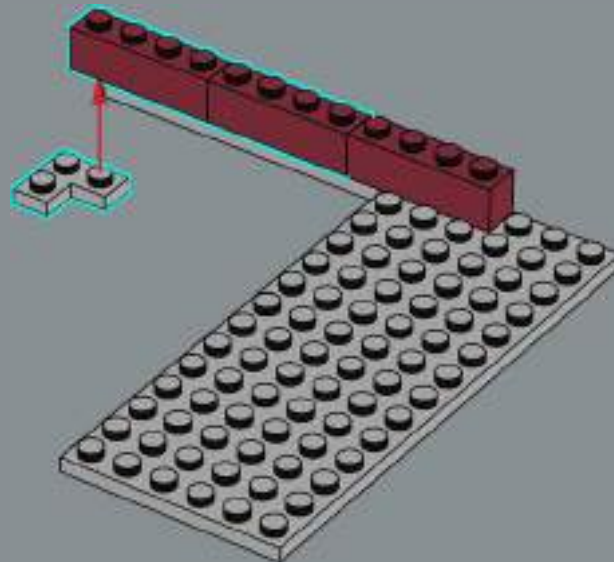

152

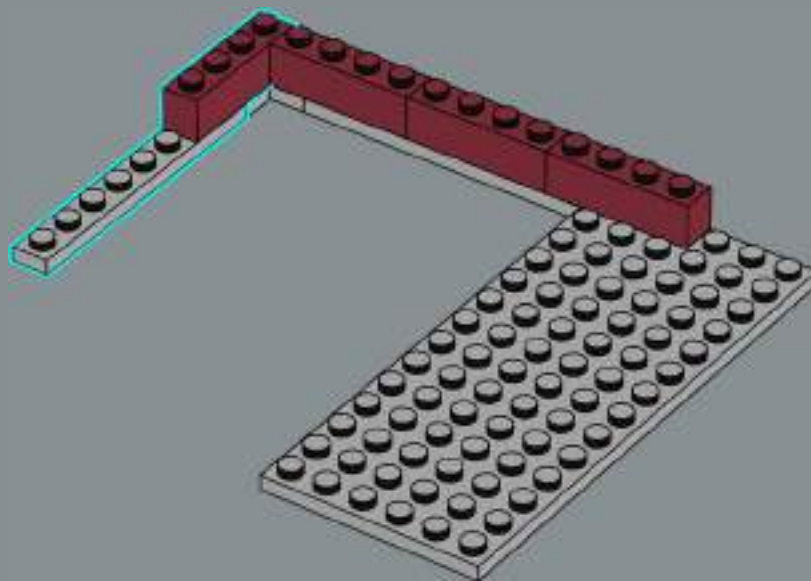

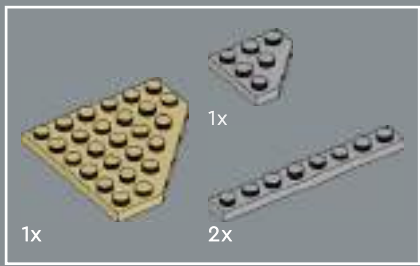

153

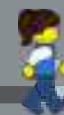
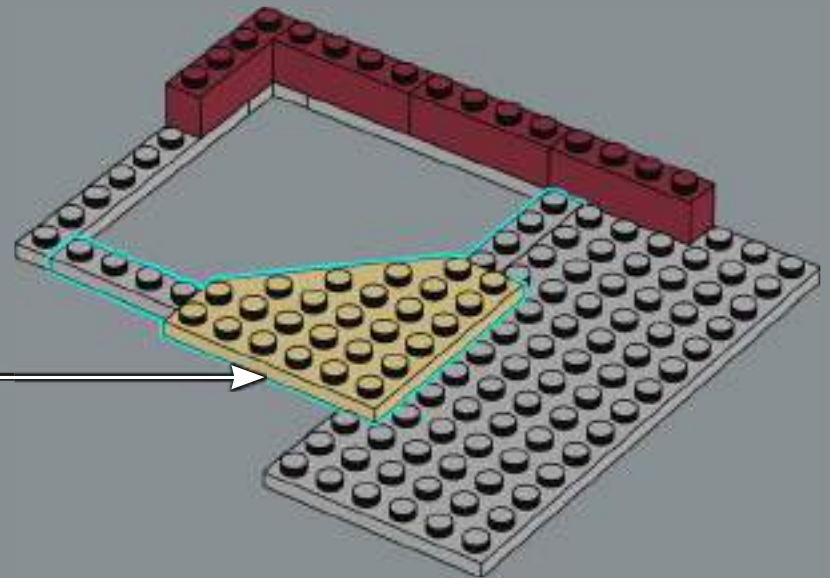
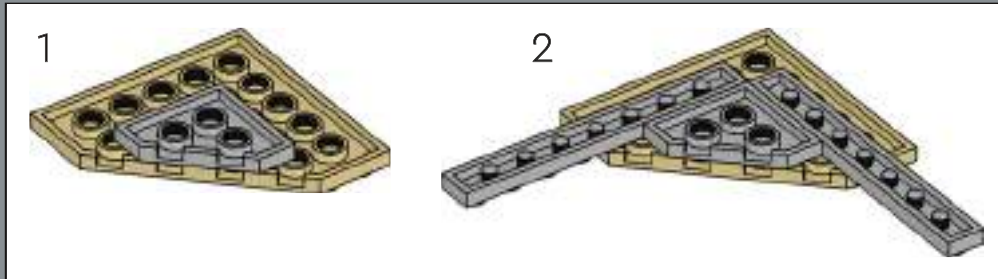



154

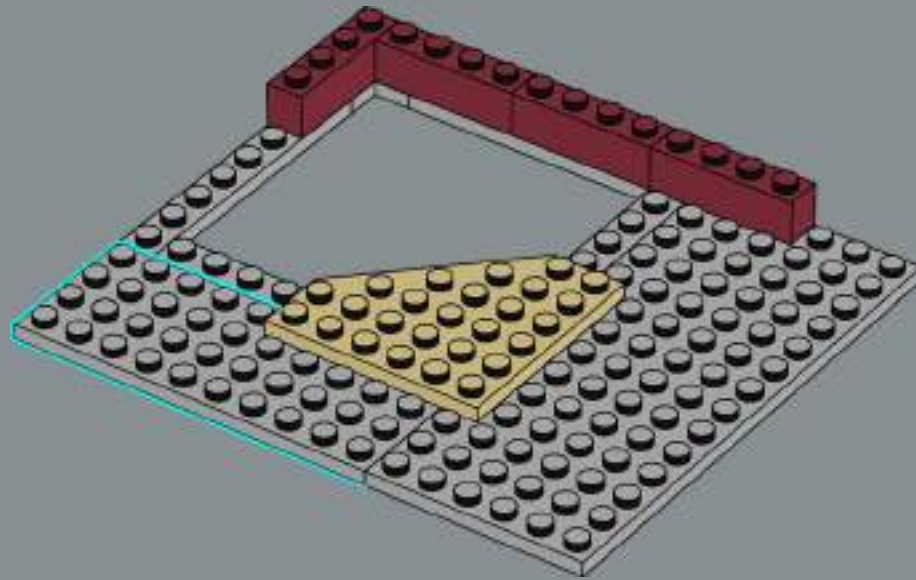

155

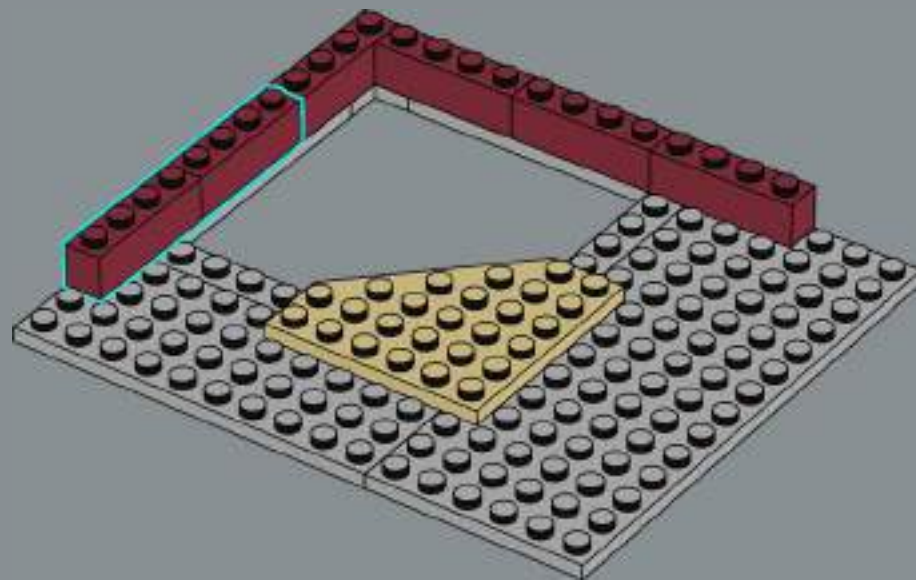

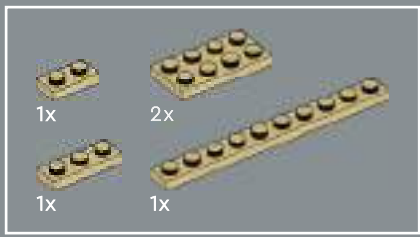

156

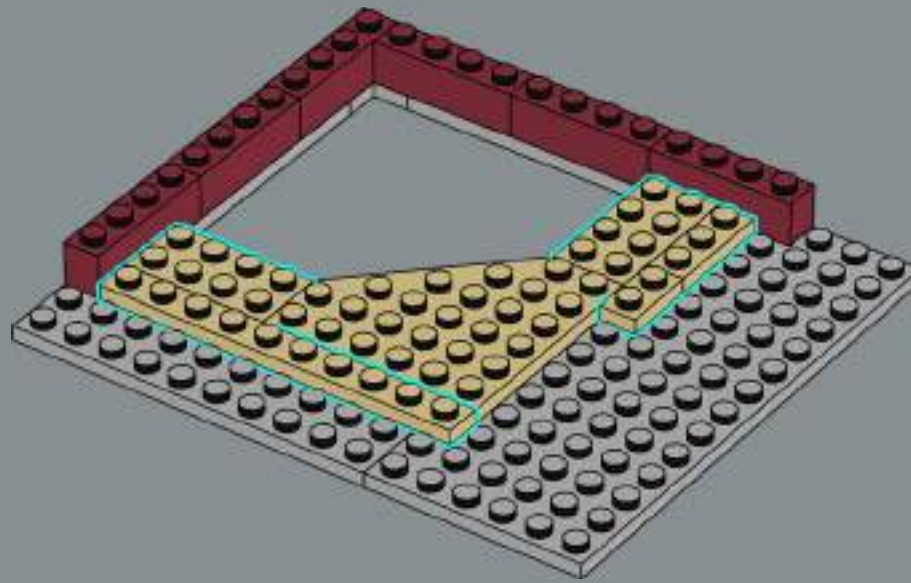

157

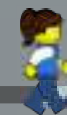
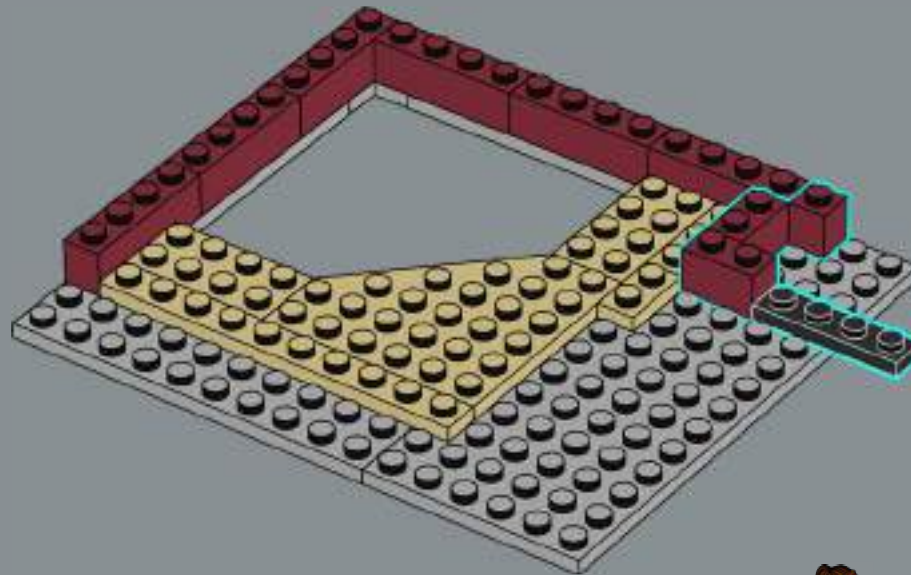

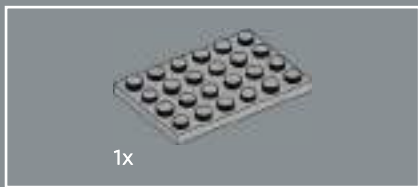

158

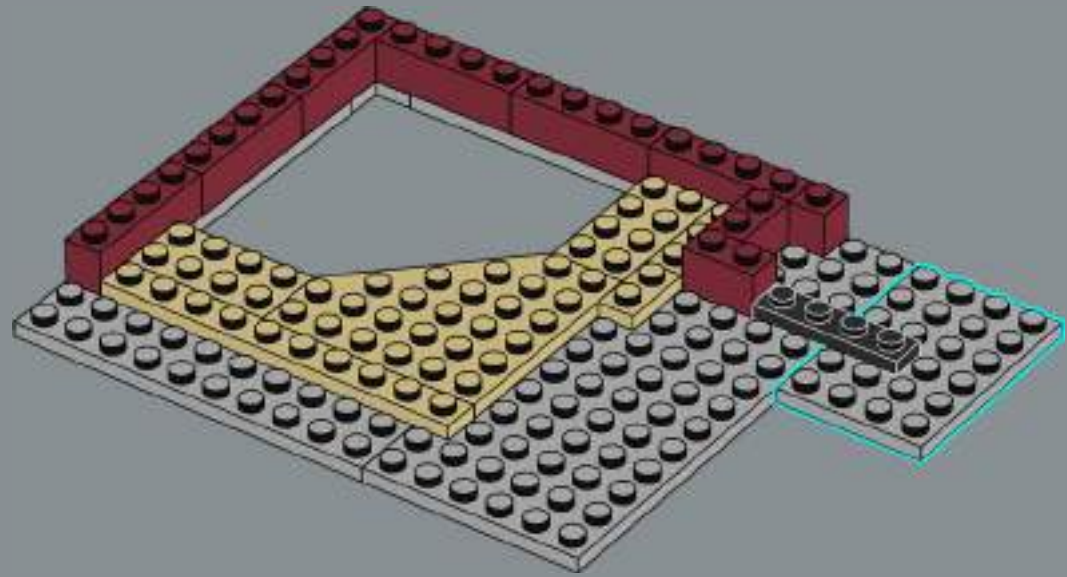

159

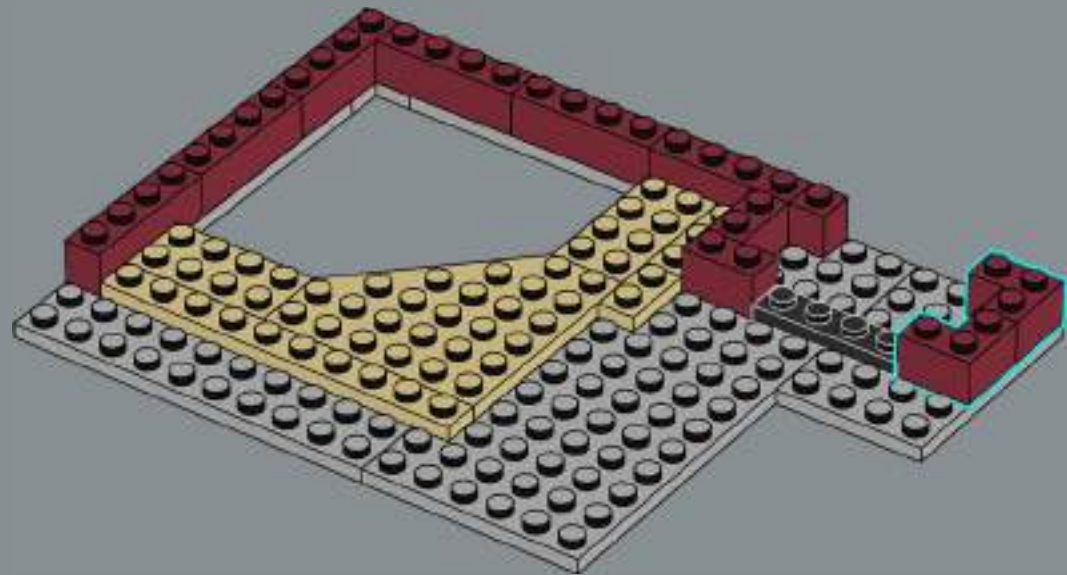



160

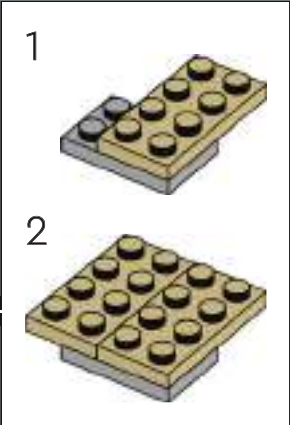
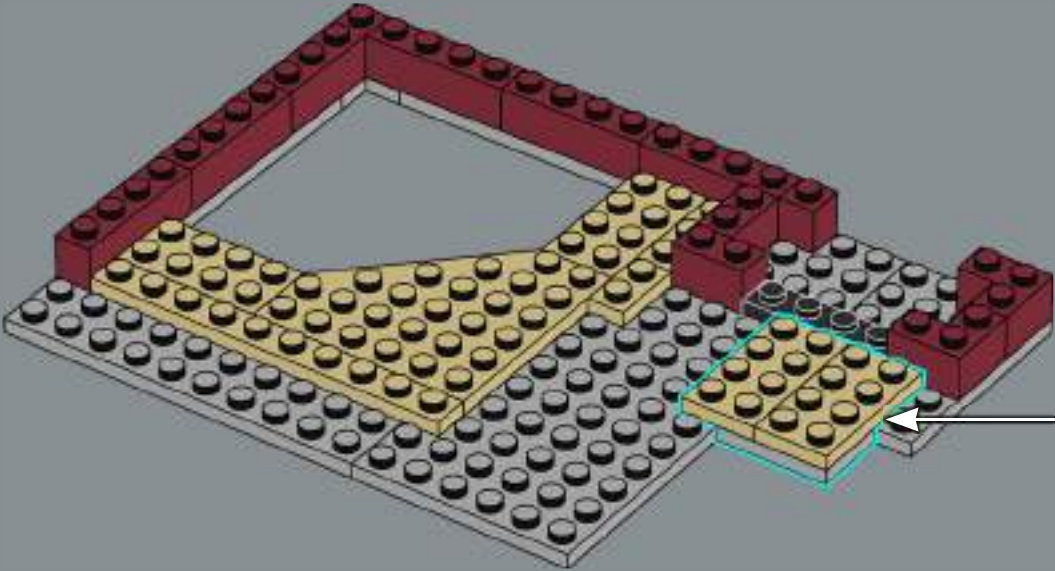



161

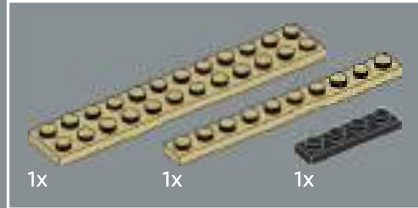
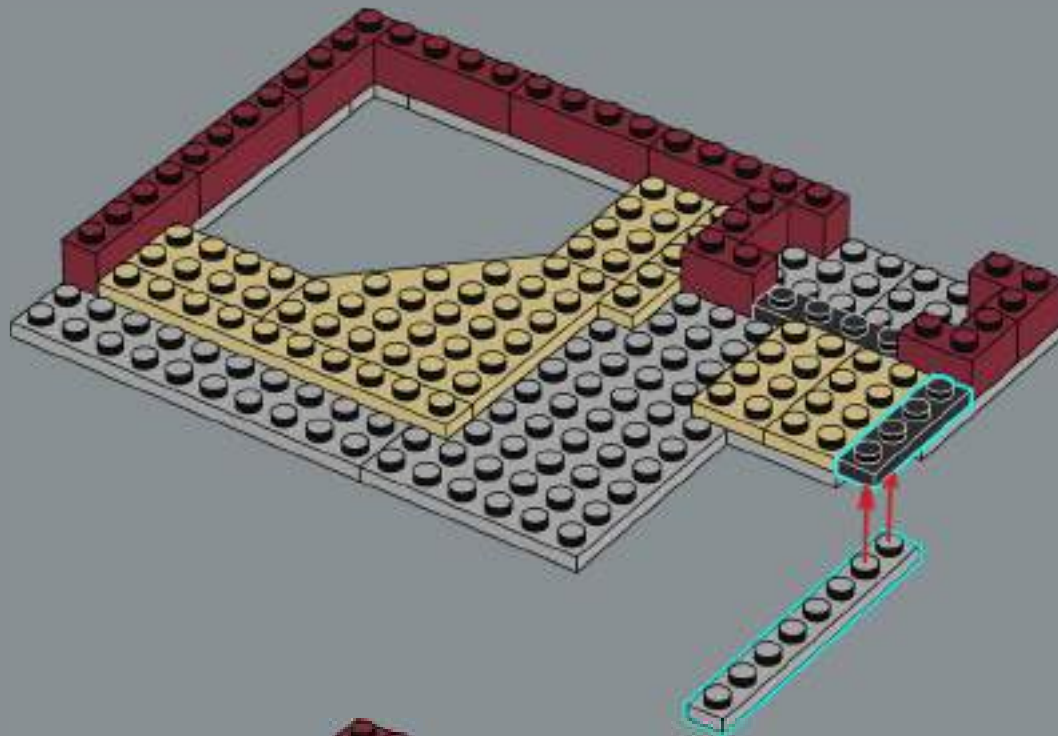

162

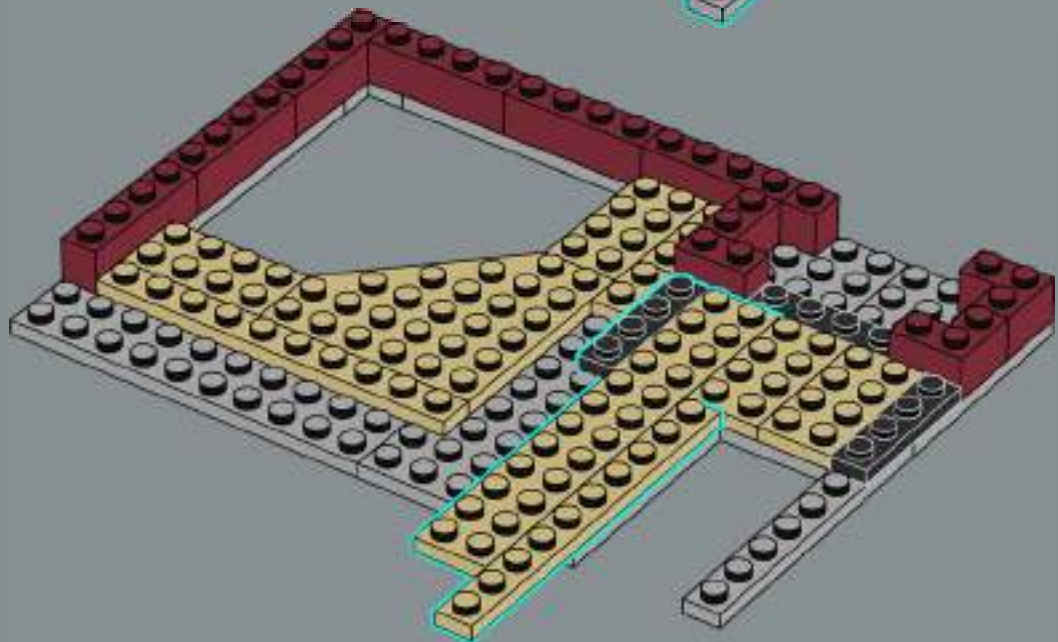

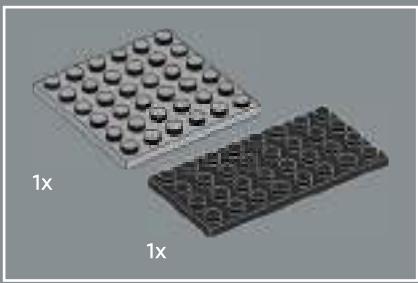

163

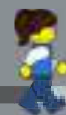
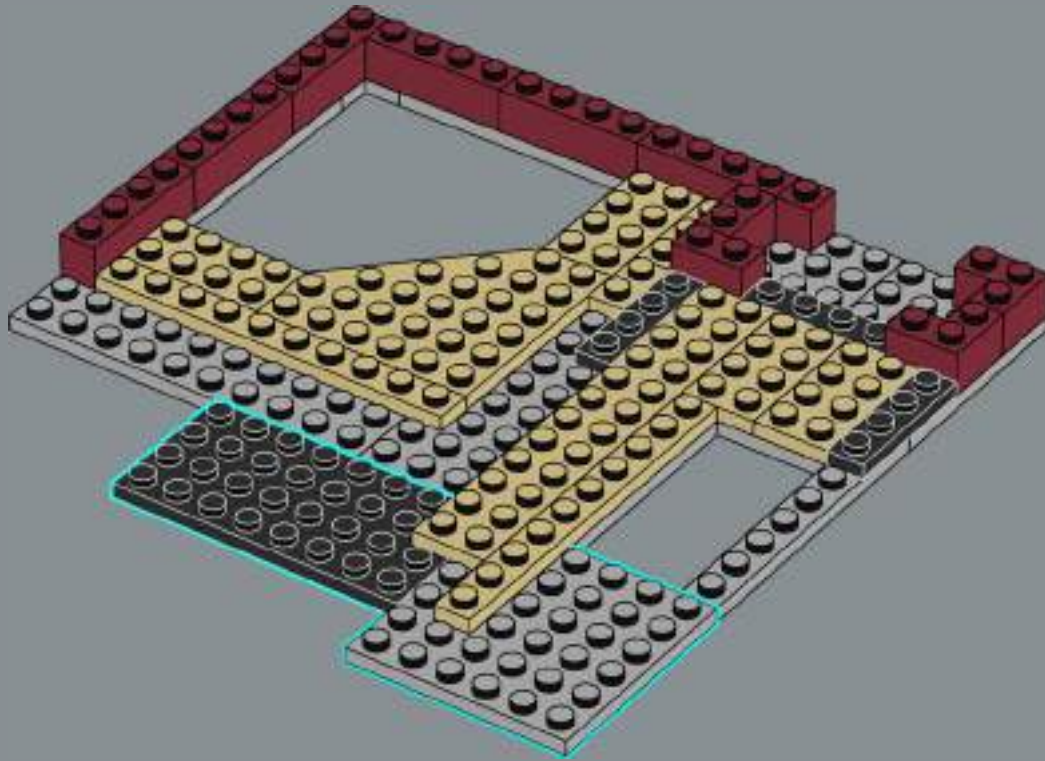

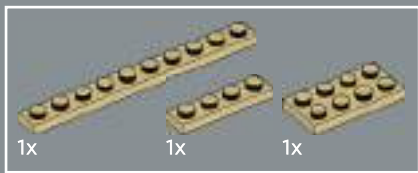

164

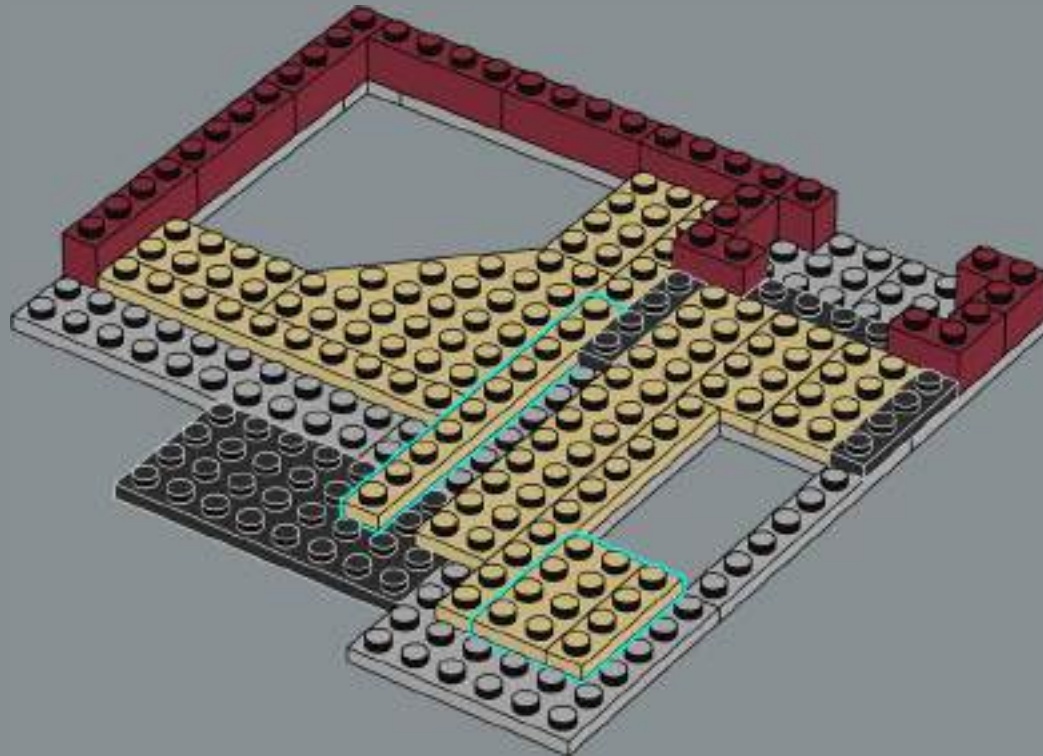



165

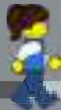
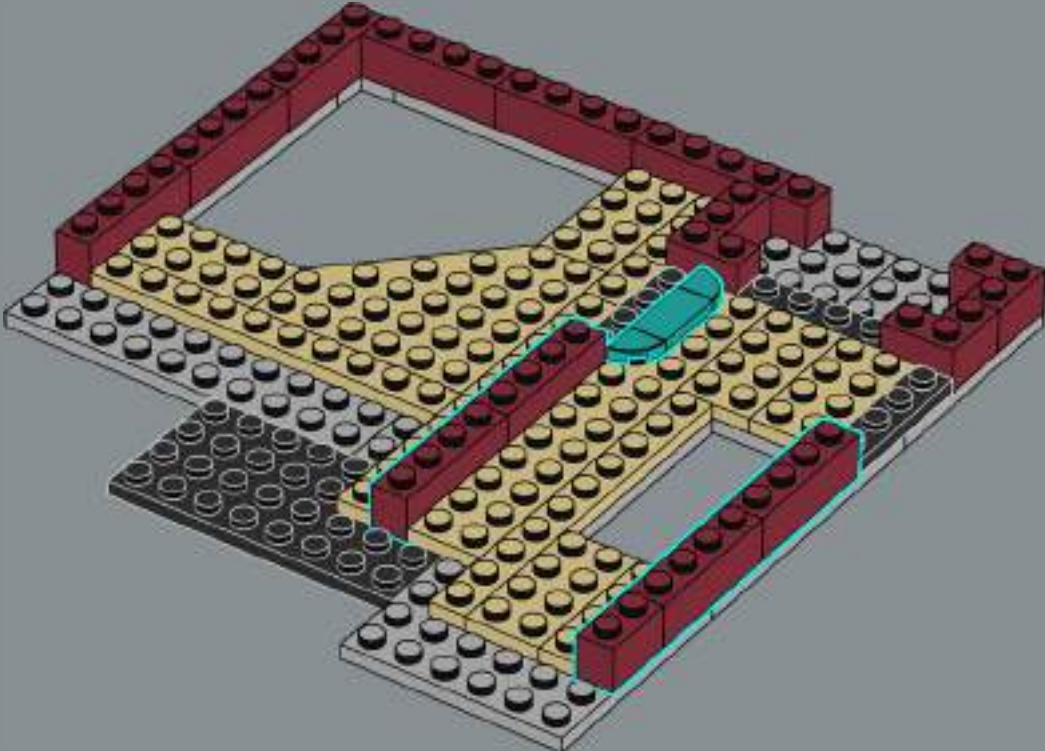

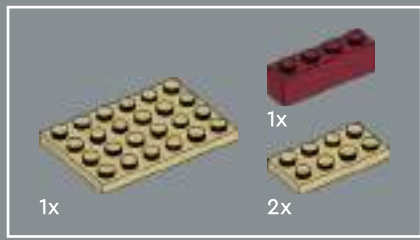

166

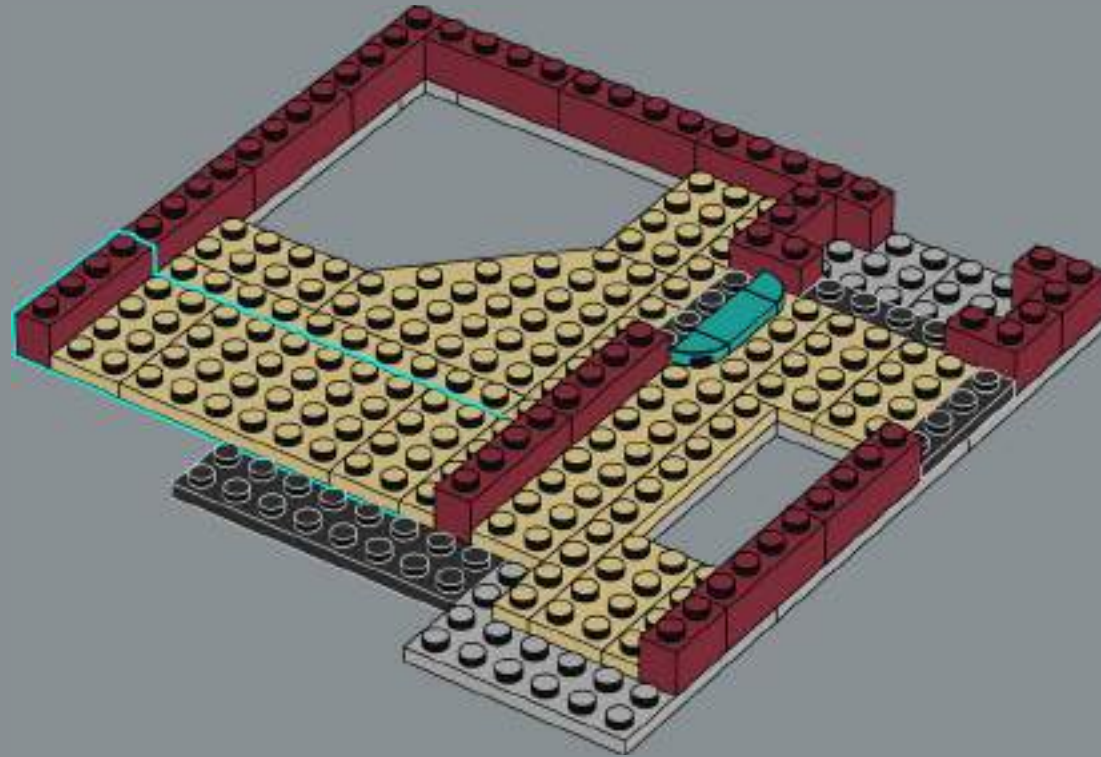



167

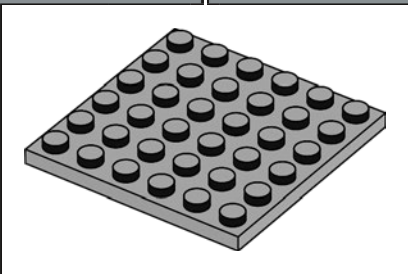
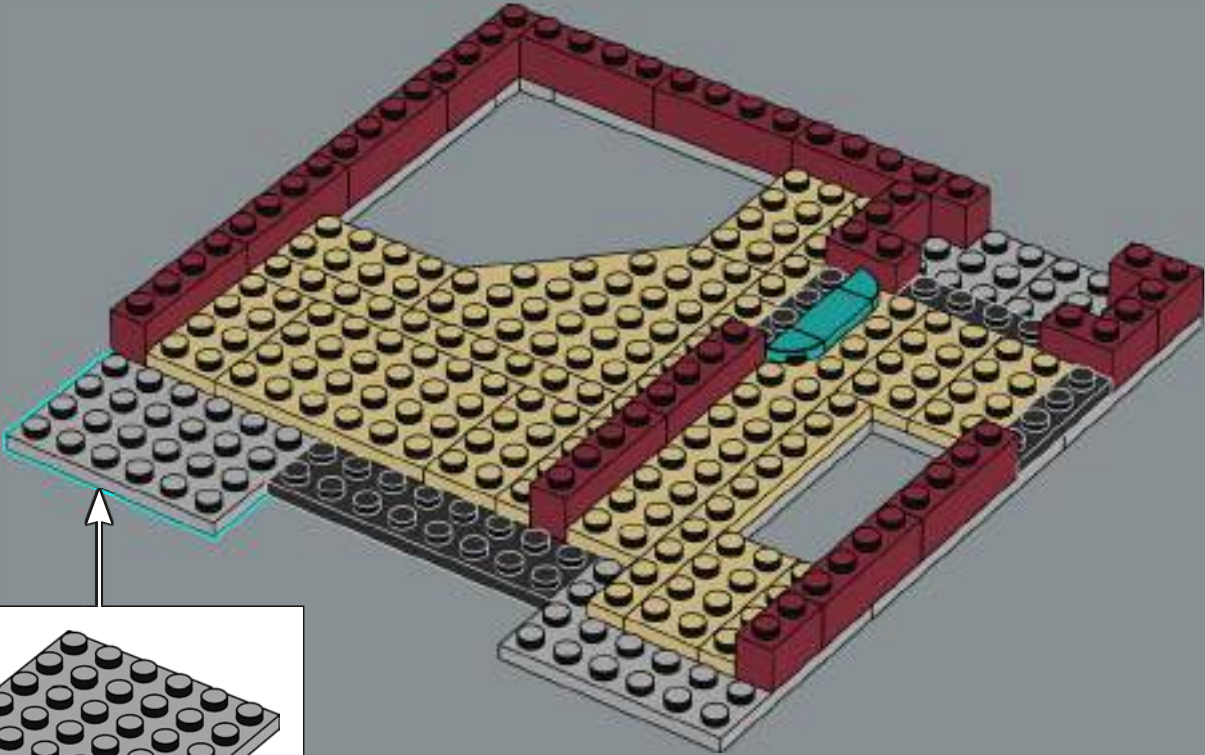

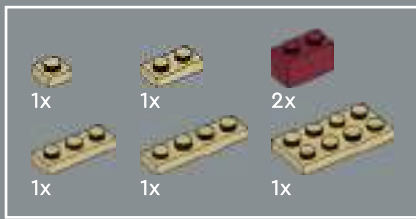

168

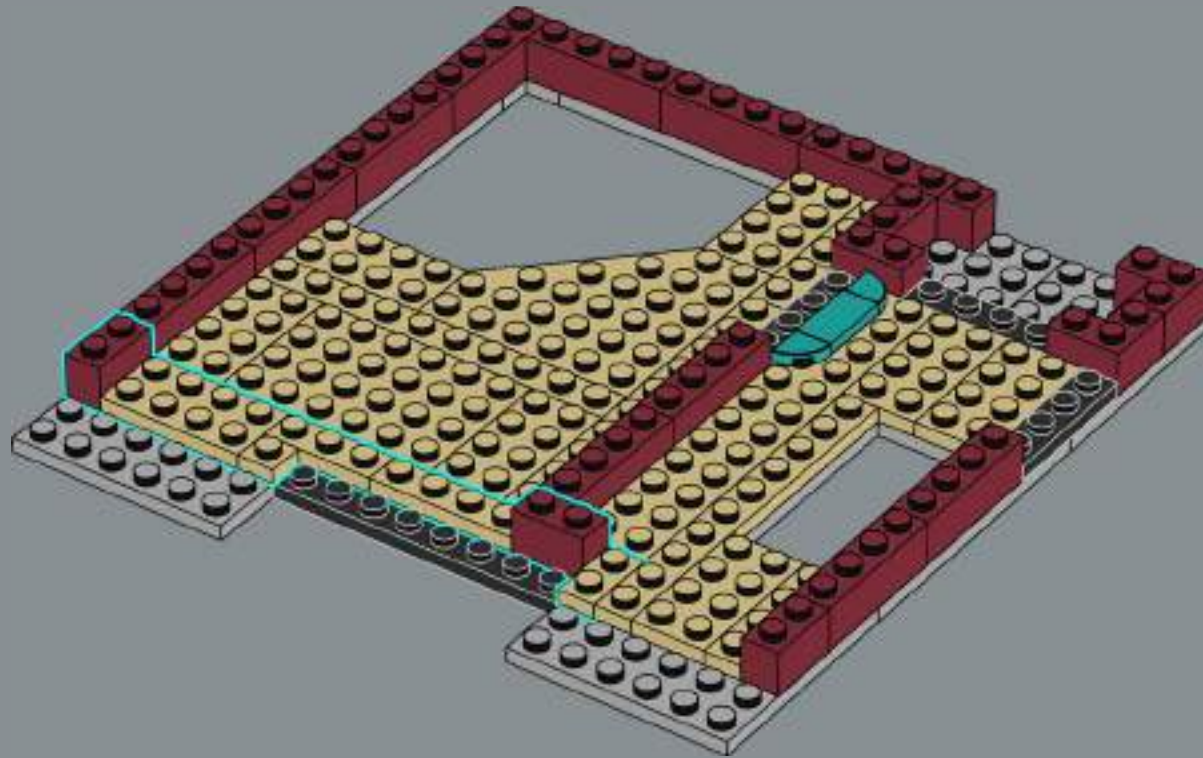

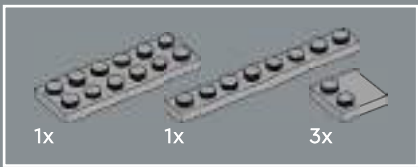

169

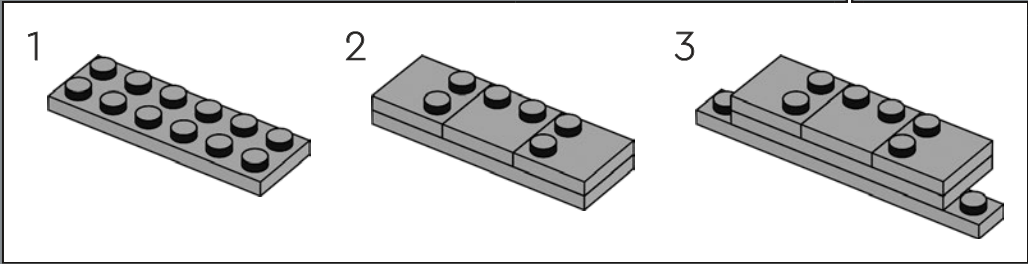
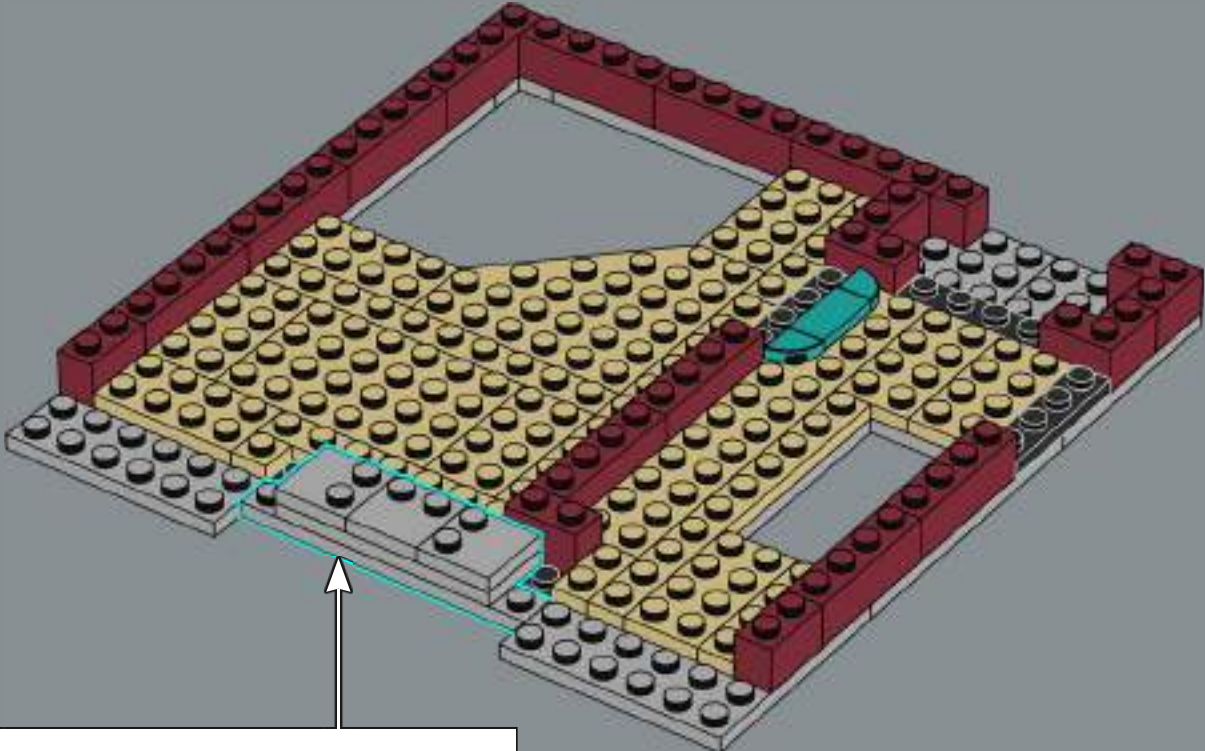



171

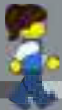
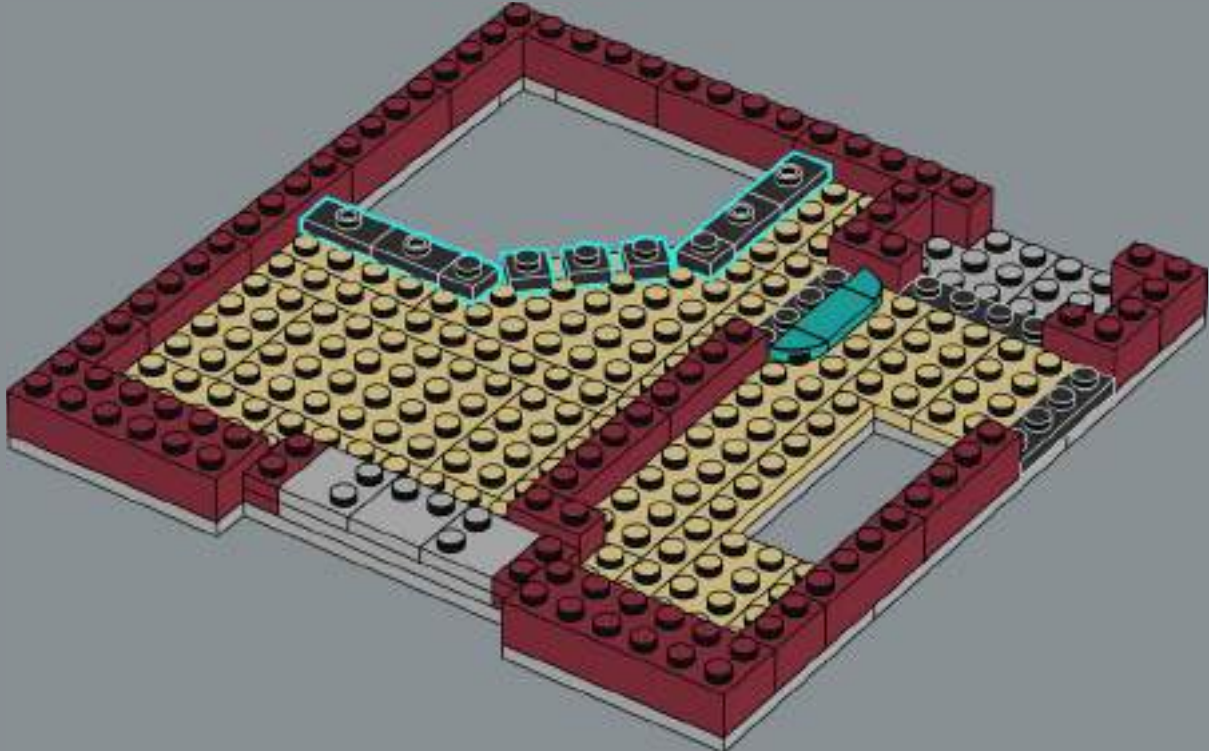

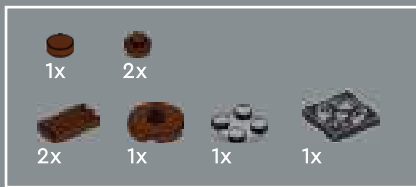

172

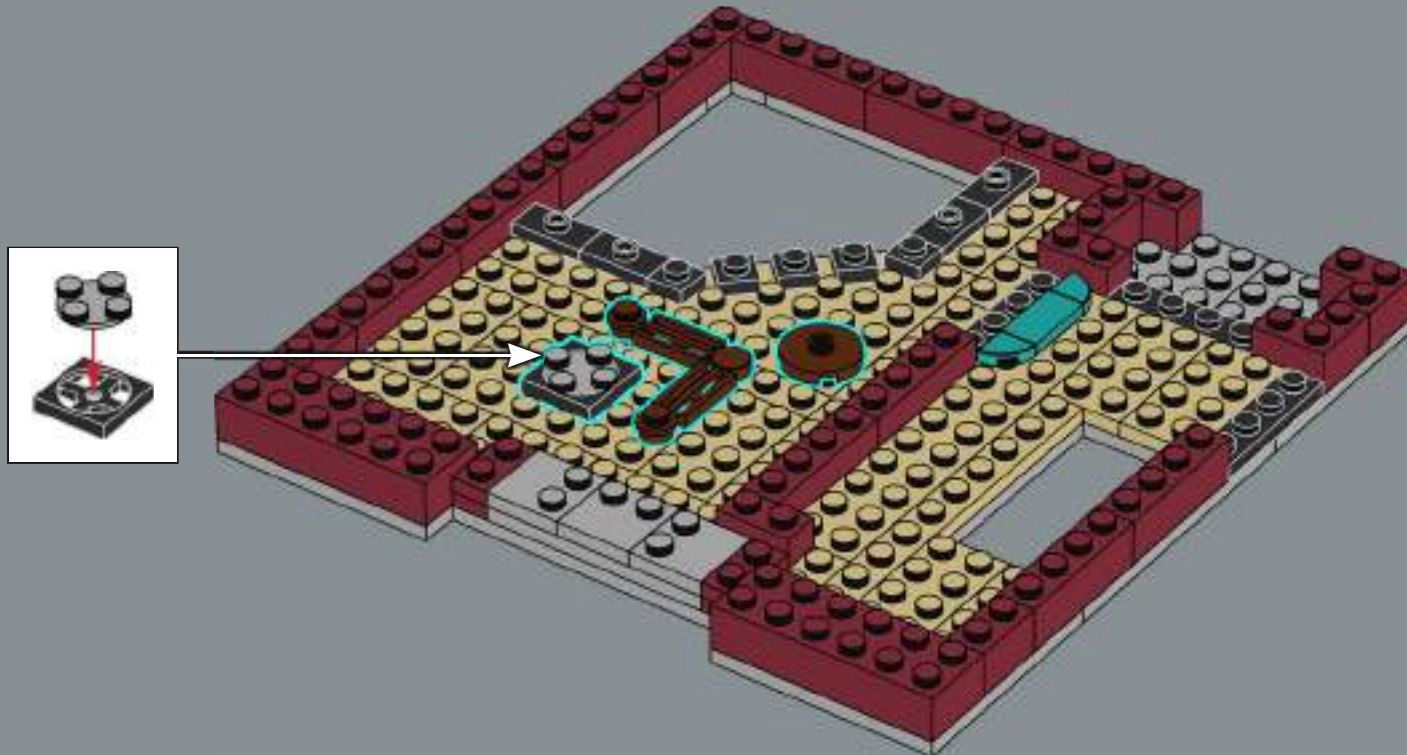



173

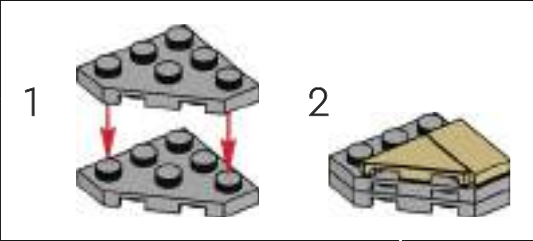

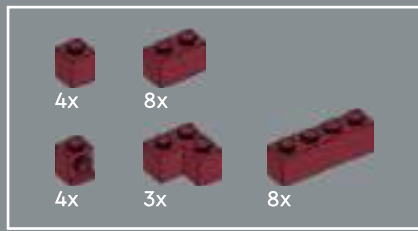

174

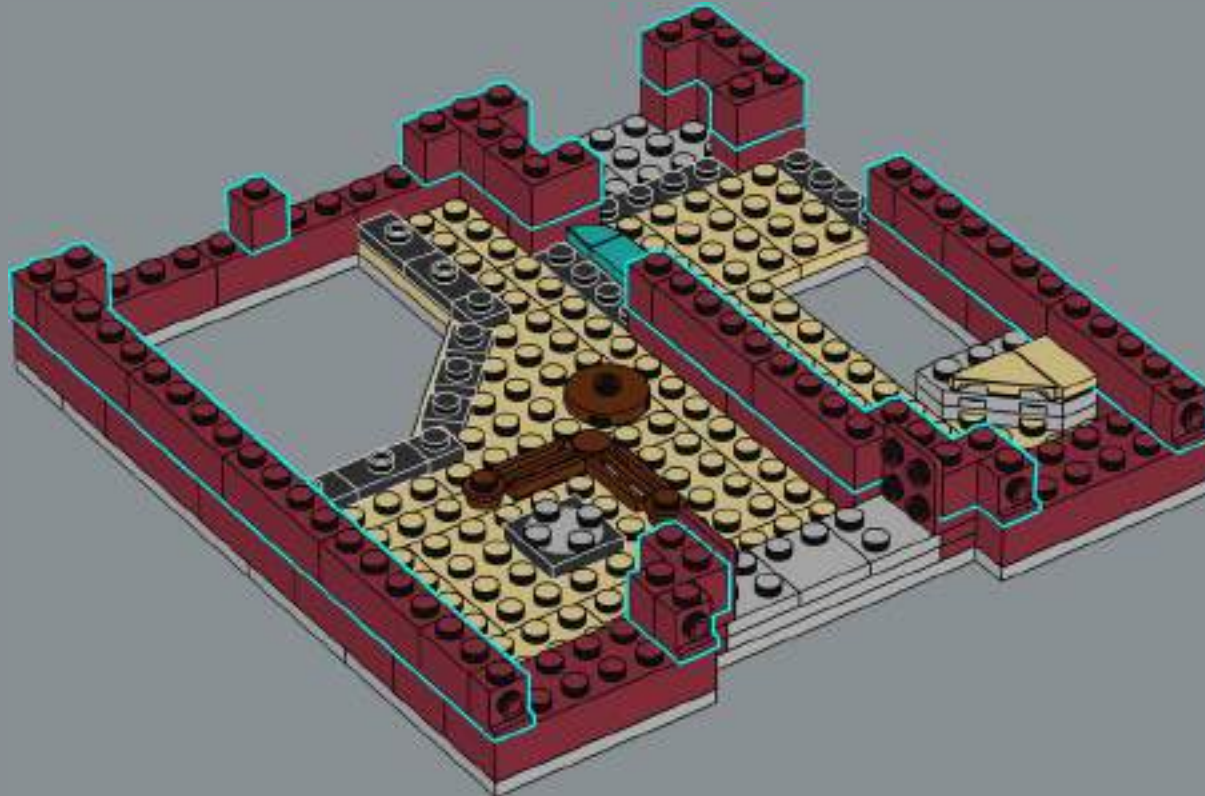

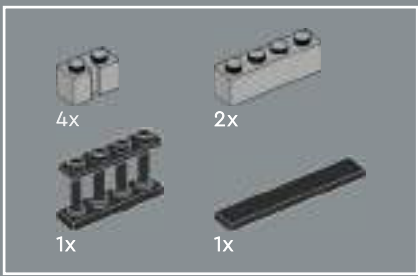

175

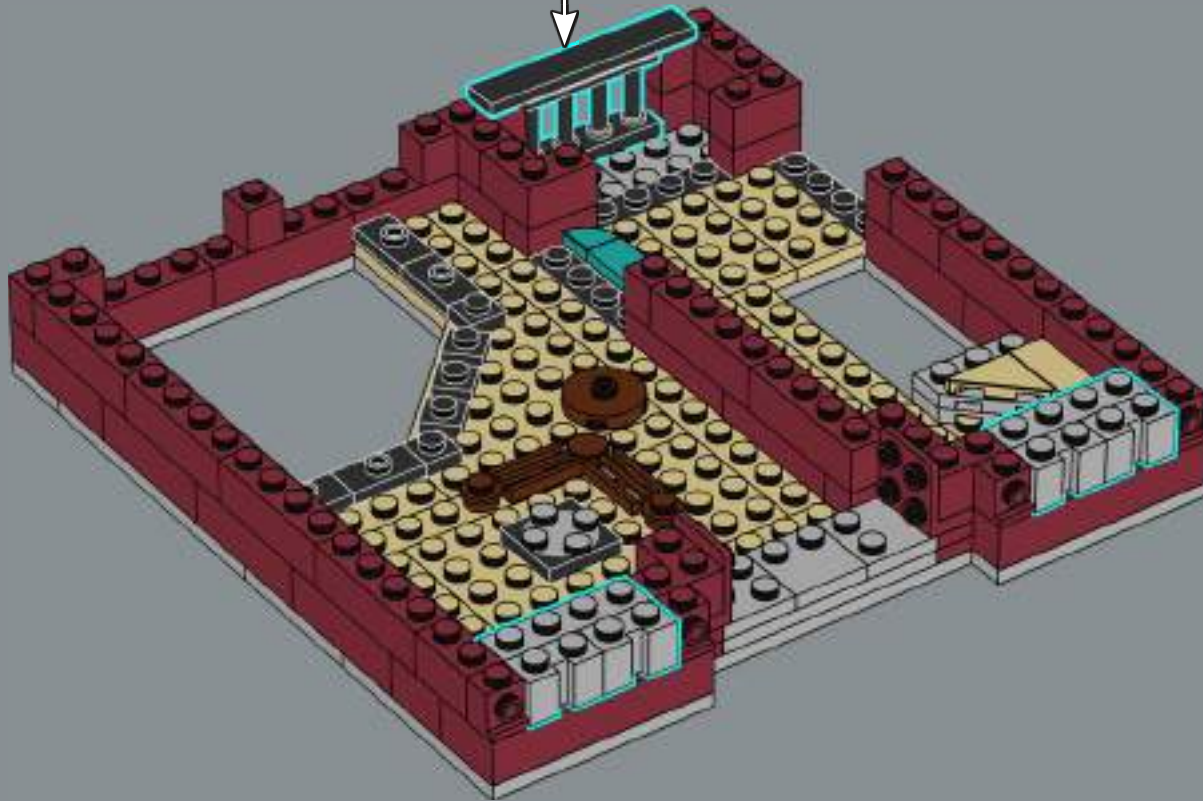
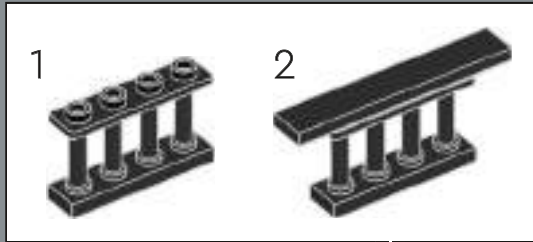



176

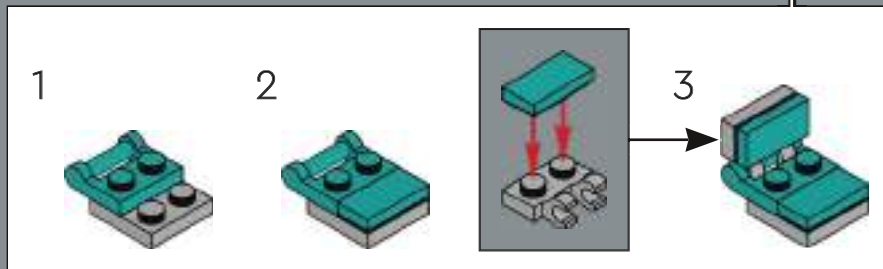
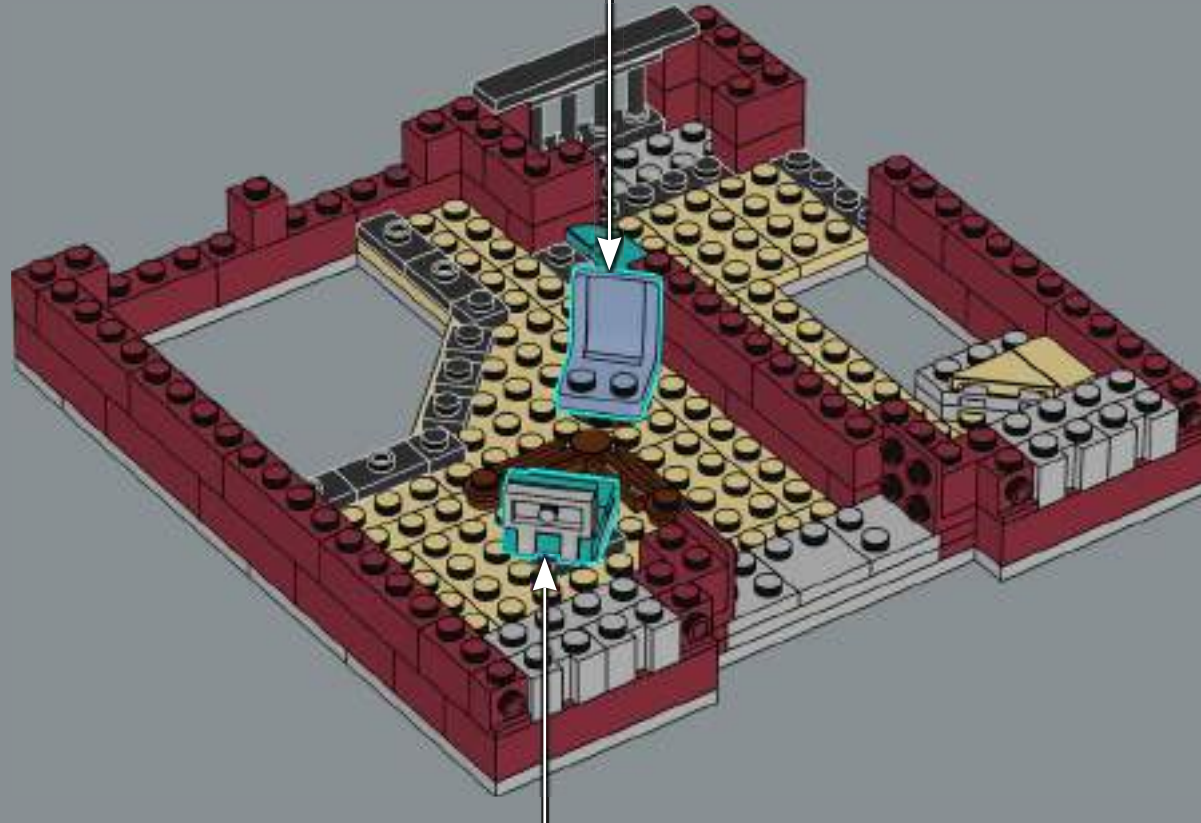



177

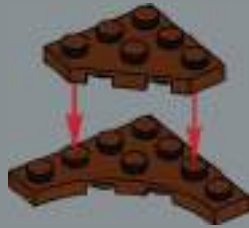

178

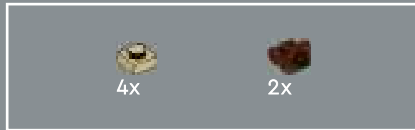

179

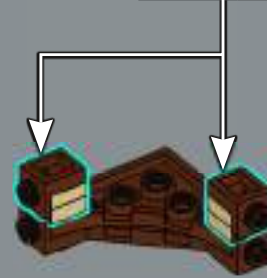
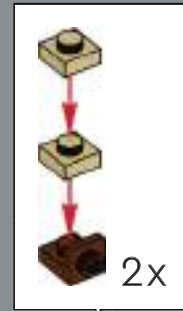

180

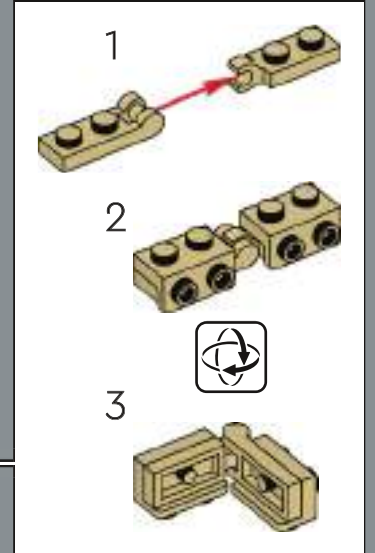



181



182

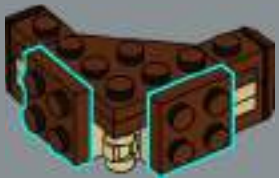

183

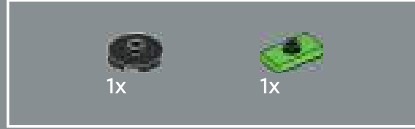
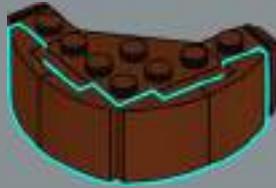

184



185



The club owner wanted something special for her office, so she ordered this unusual desk that is oriented to a 45-degree angle.

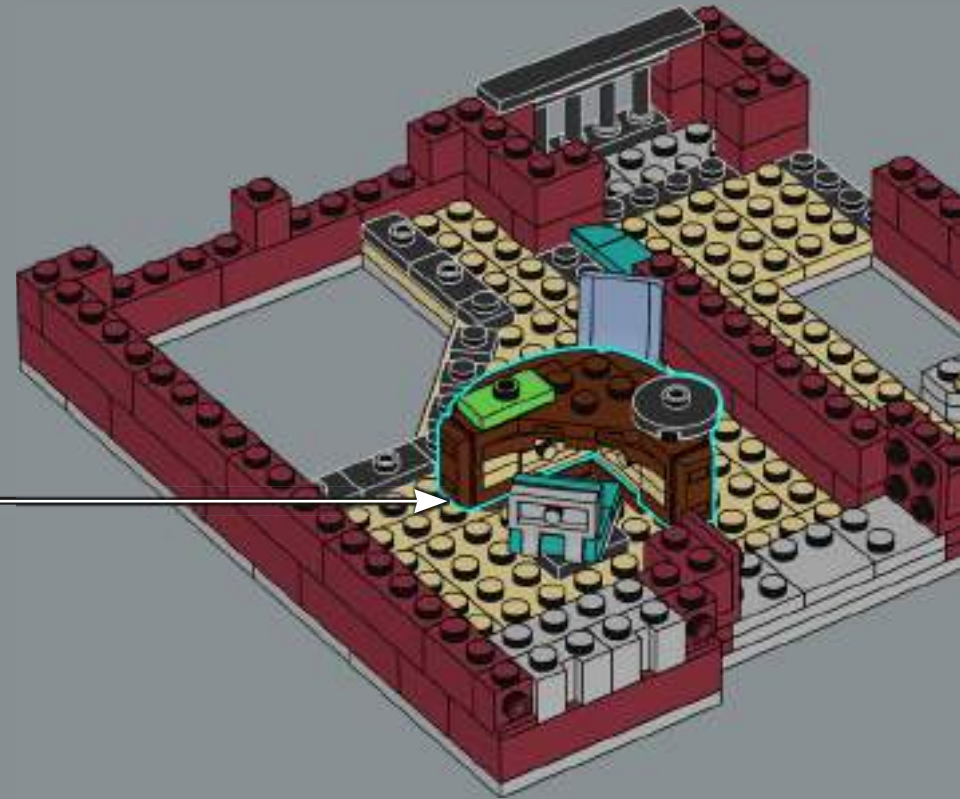

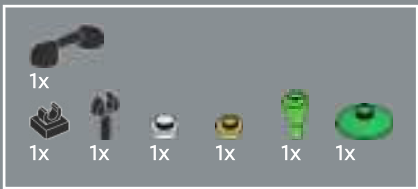

186

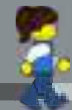



The club owner loves spotting up-and-coming artists and giving them a chance to shine on stage. She was one of the first to recognise the talent of the saxophone player from the LEGO® 10255 Assembly Square.

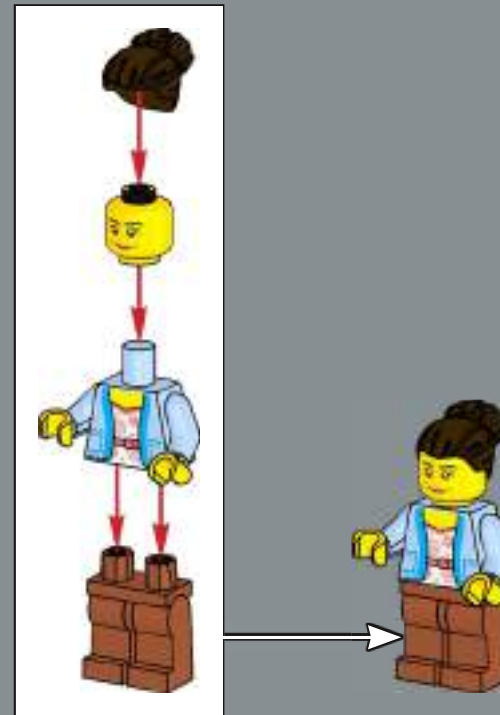



187

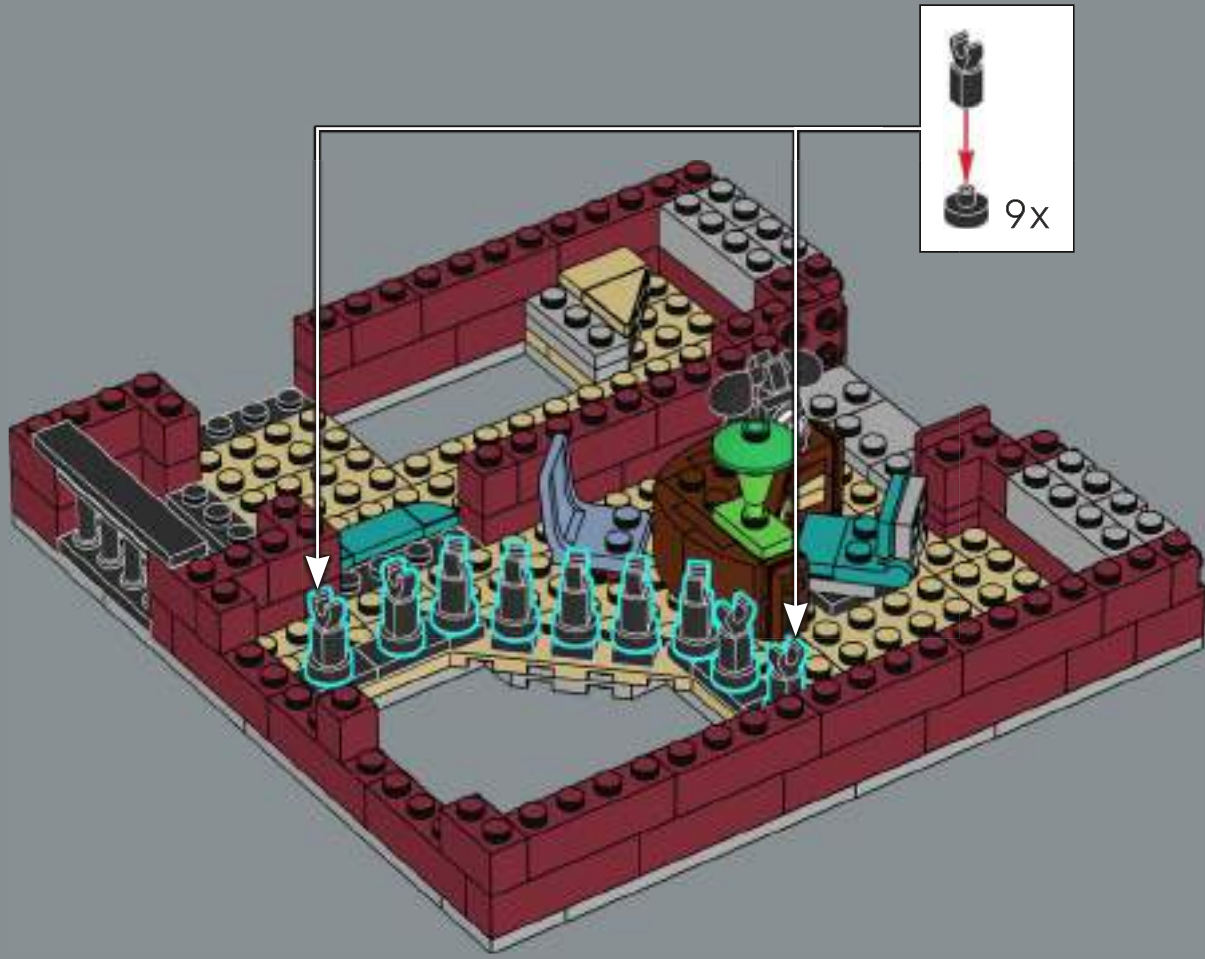



The manager has her own private balcony where she can listen in on the evening's performances.



188

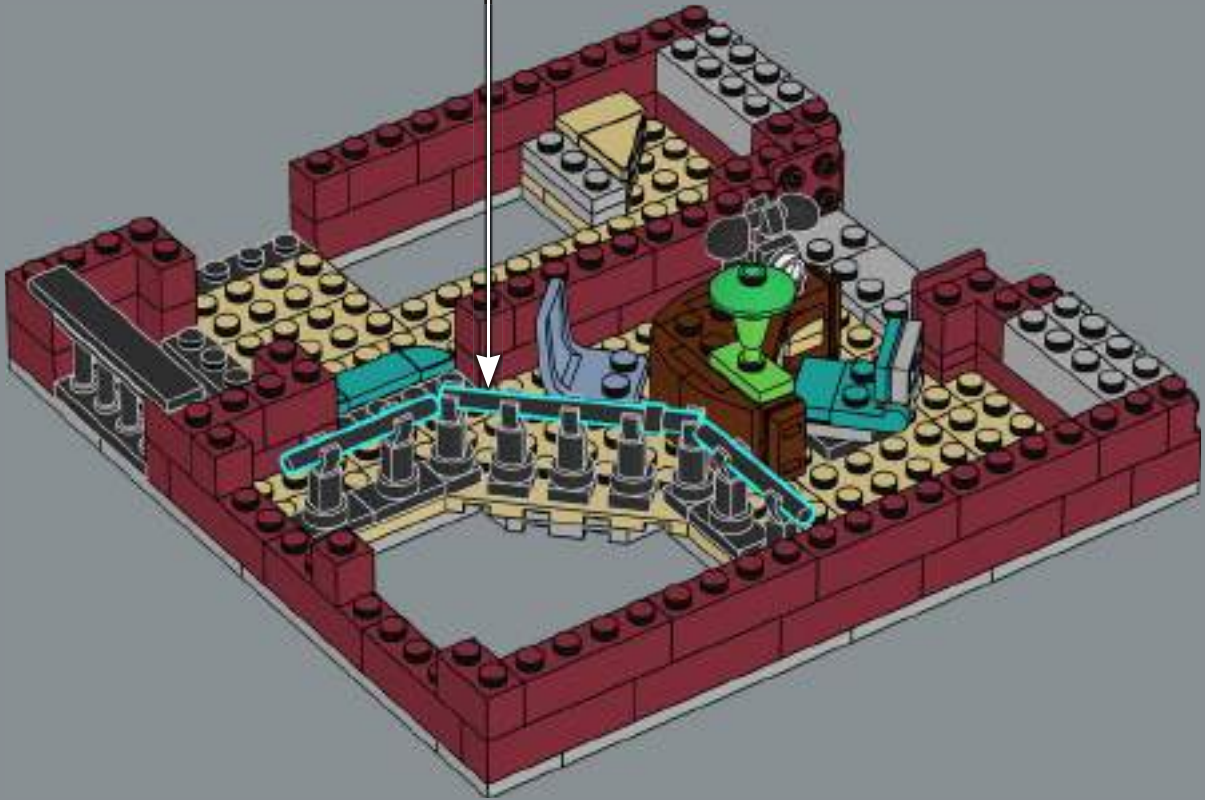



189

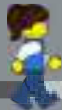
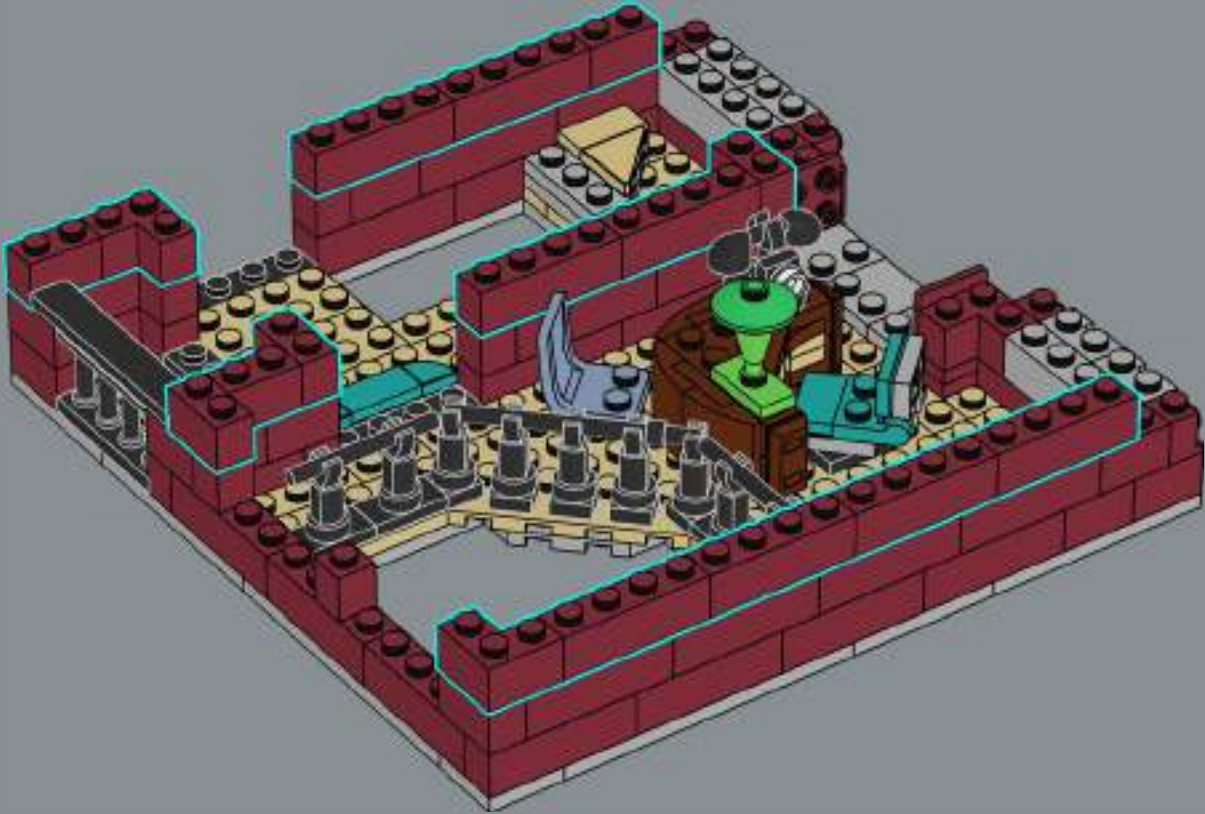



190

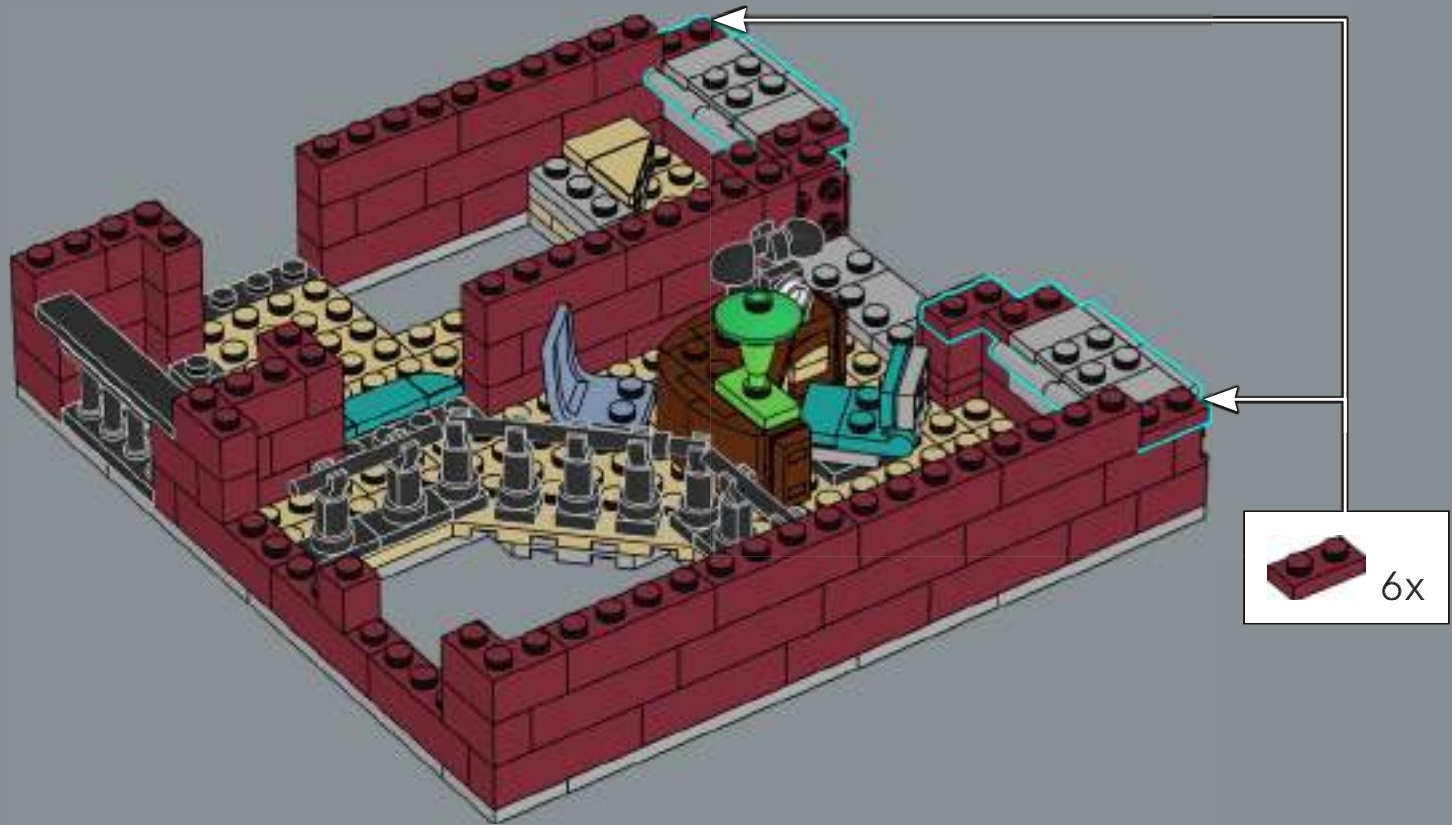

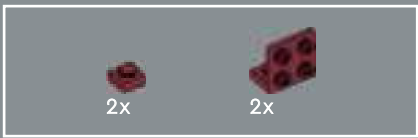

191

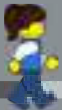
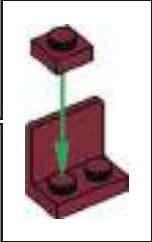
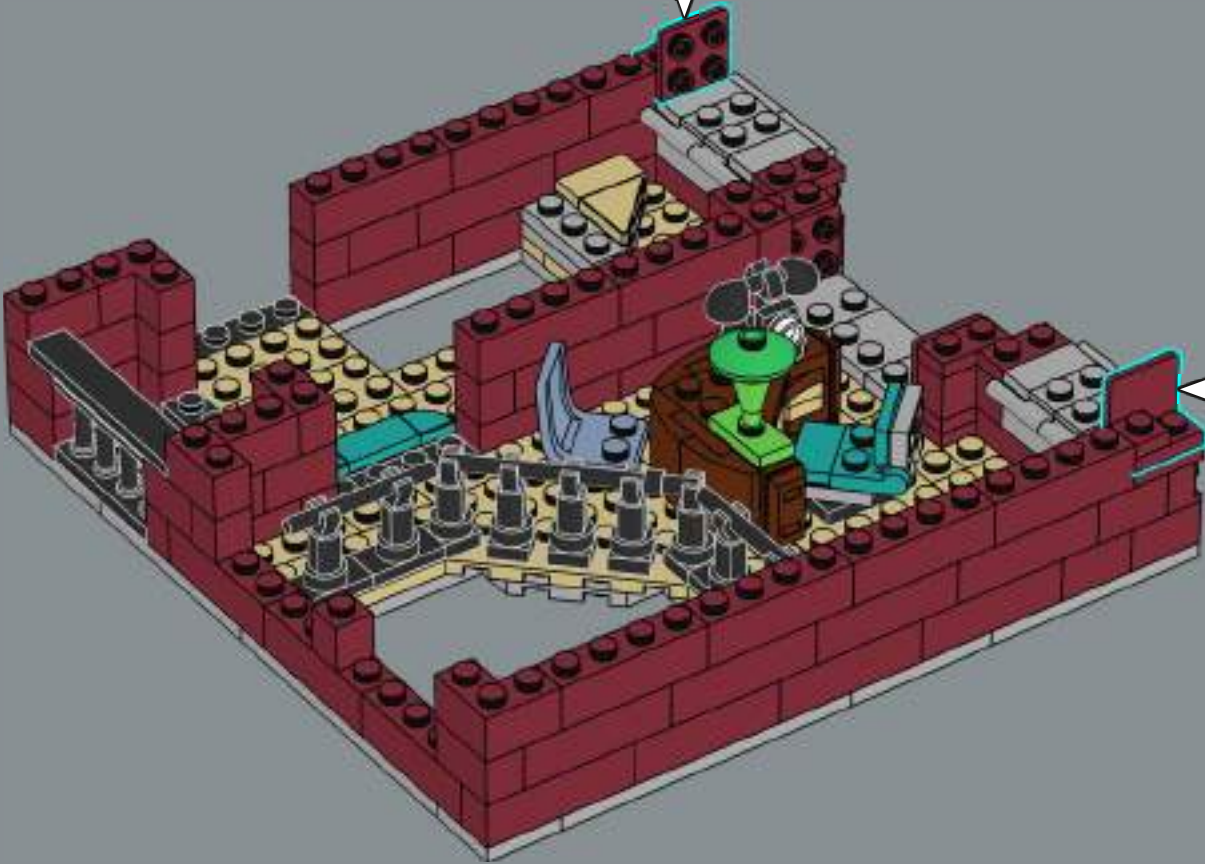
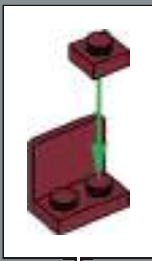

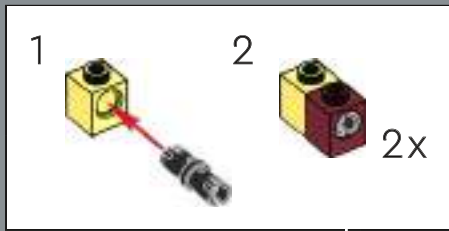
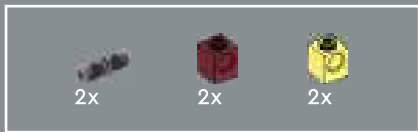

192





194

1

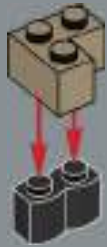

2



3



4

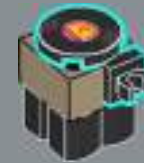

5





In addition to live music, the club owner loves listening to the latest hits on vinyl. Recently she listened to the chart-topping new album by the rock star from the LEGO® 10260 Downtown Diner.



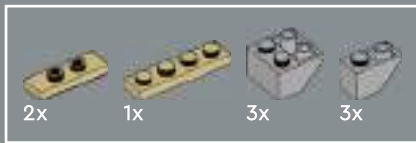

195

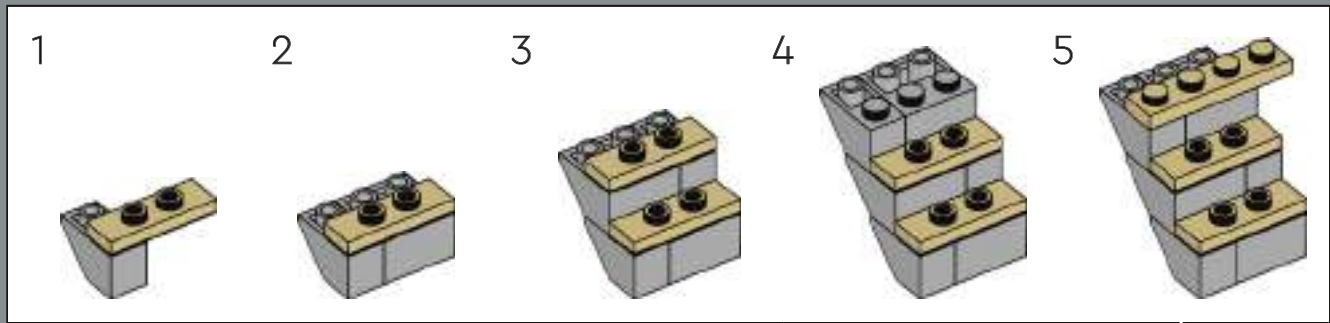



4x

196

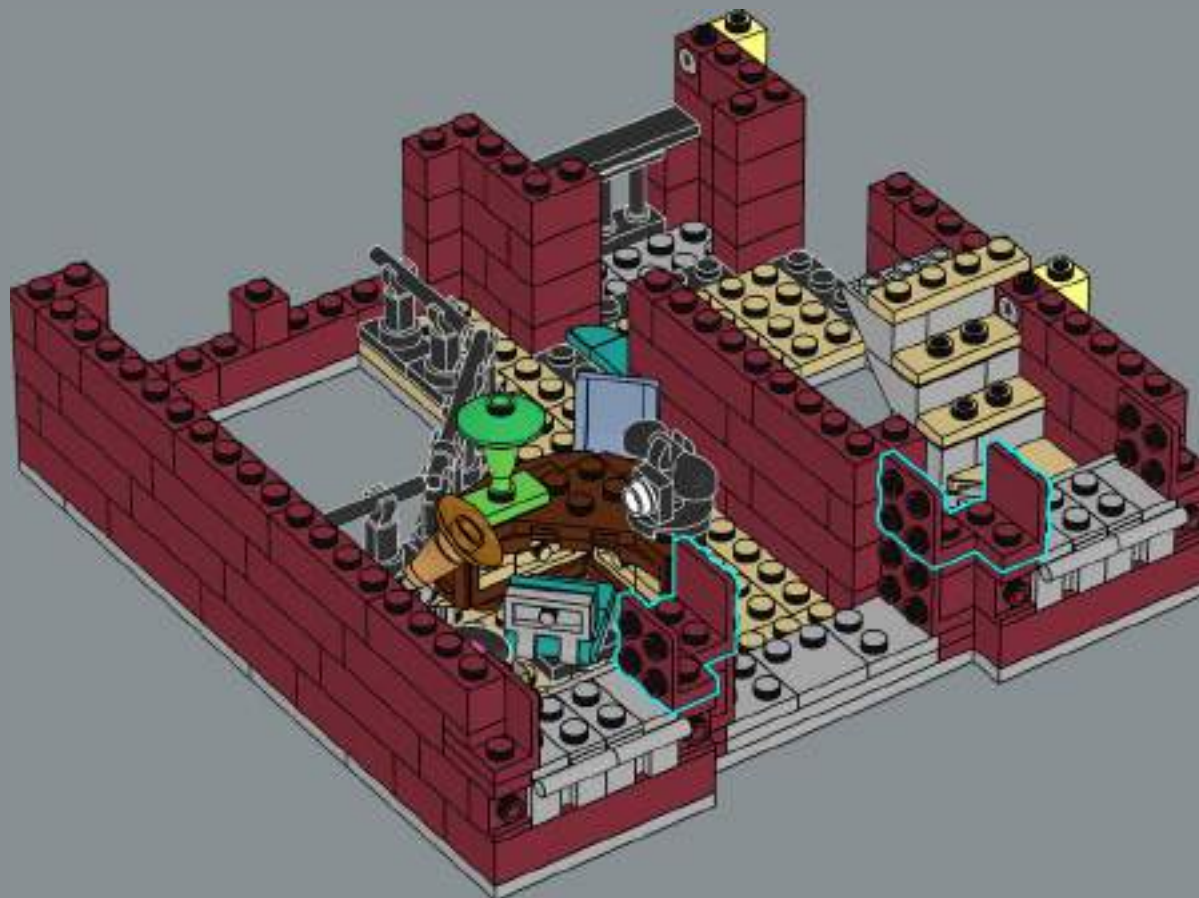



197

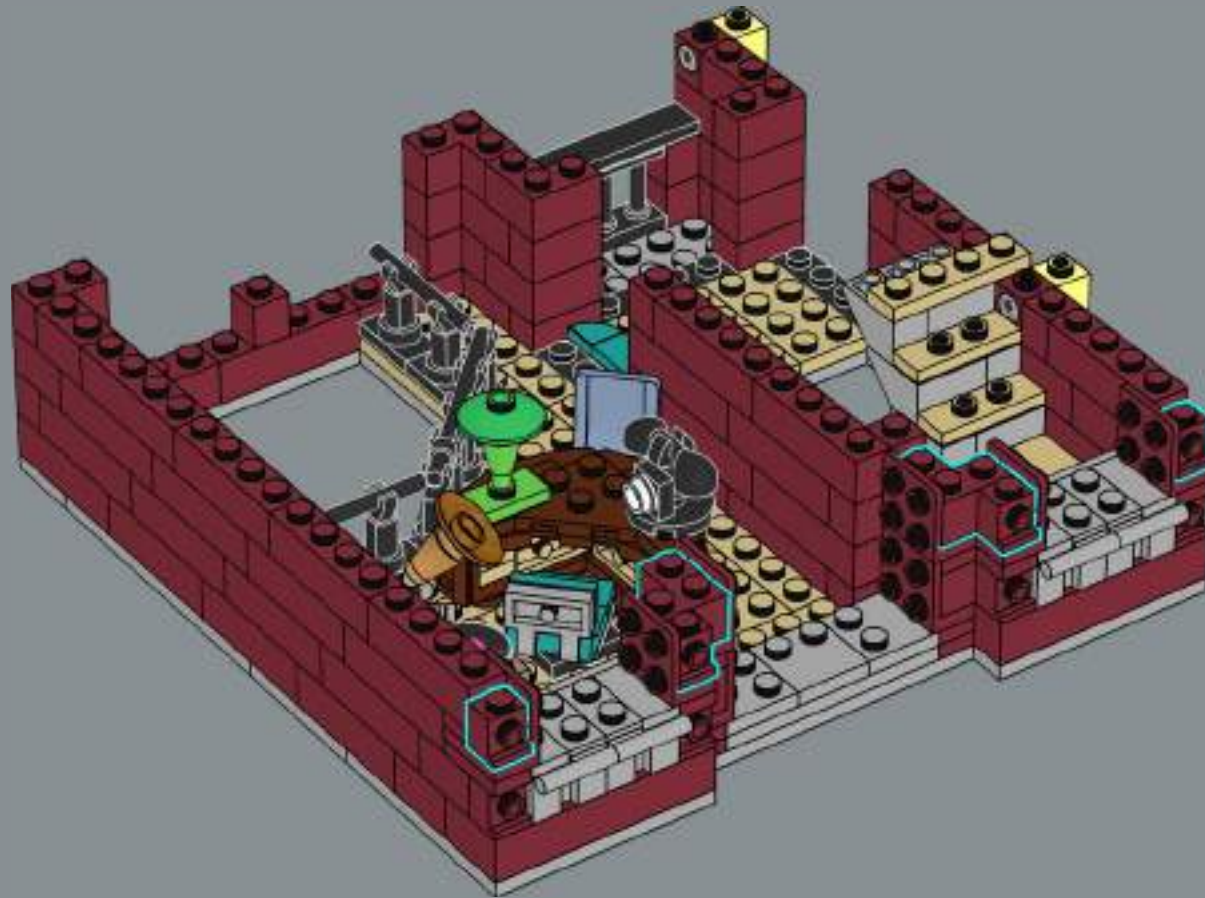



198

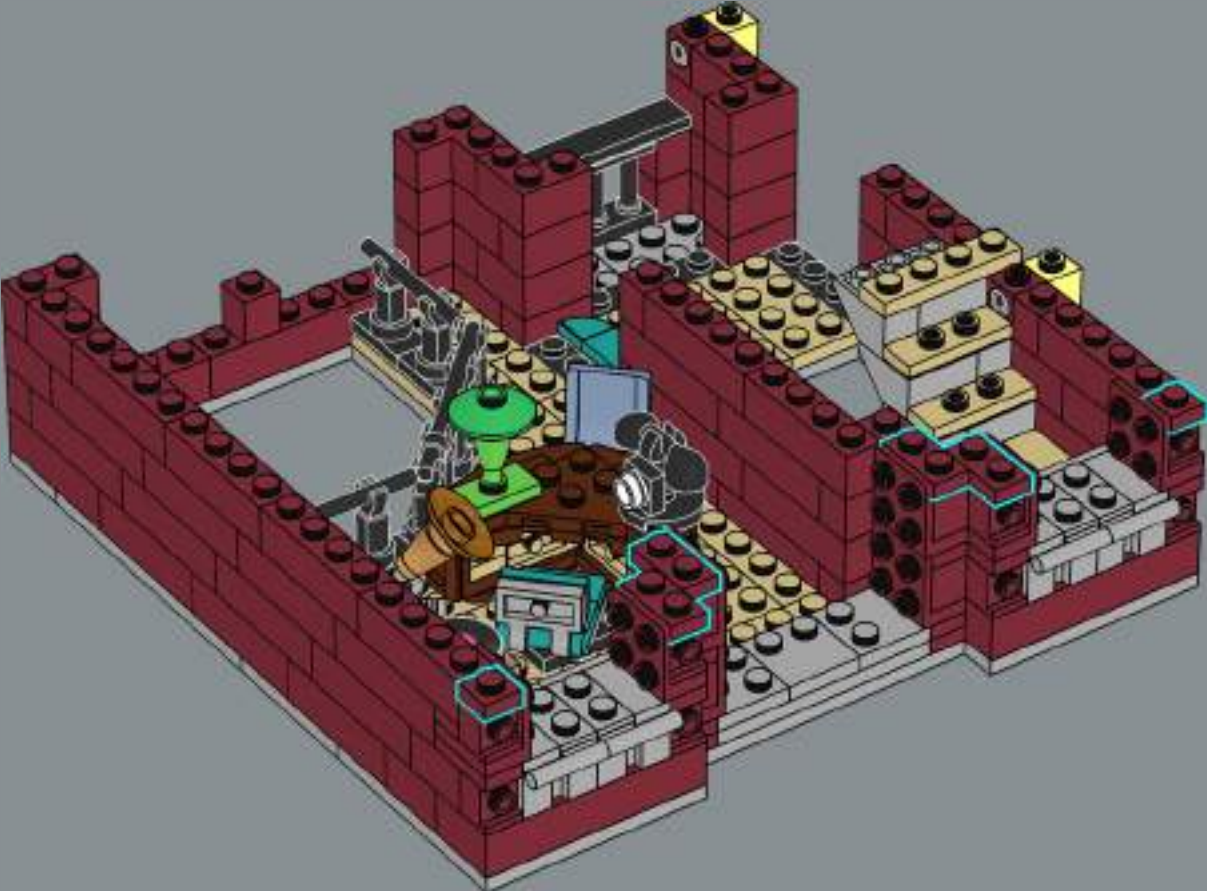

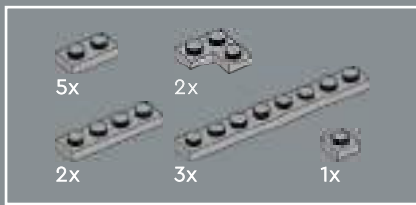

199





6x

200

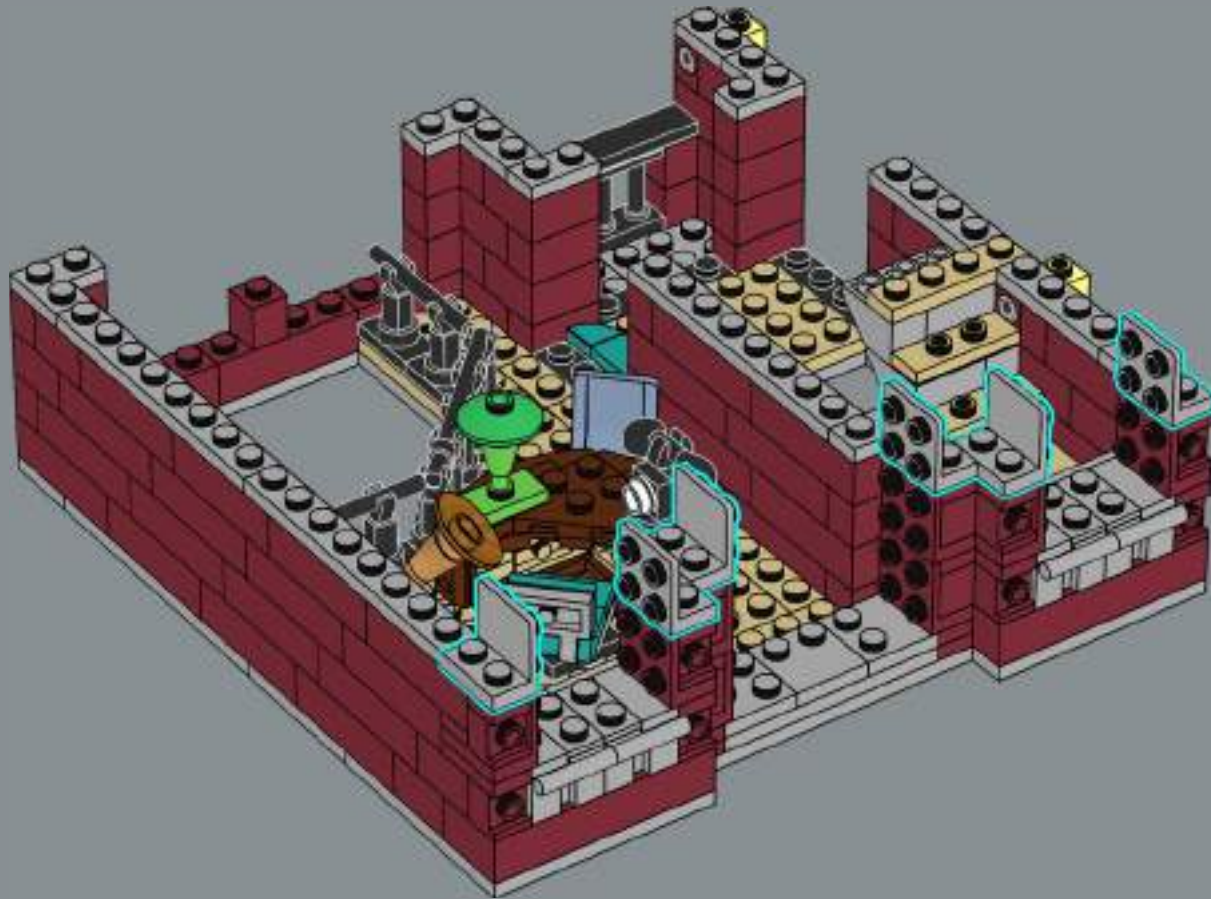

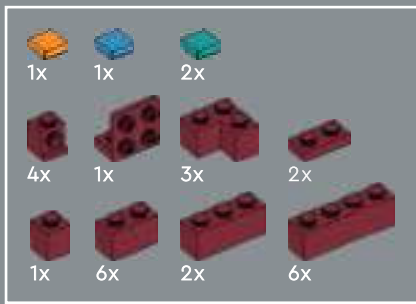

201

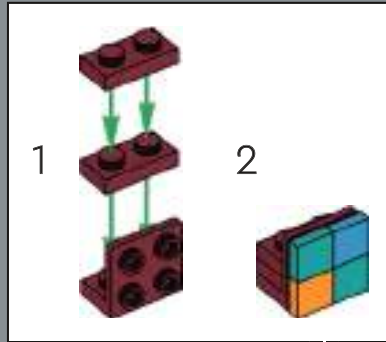

1

2

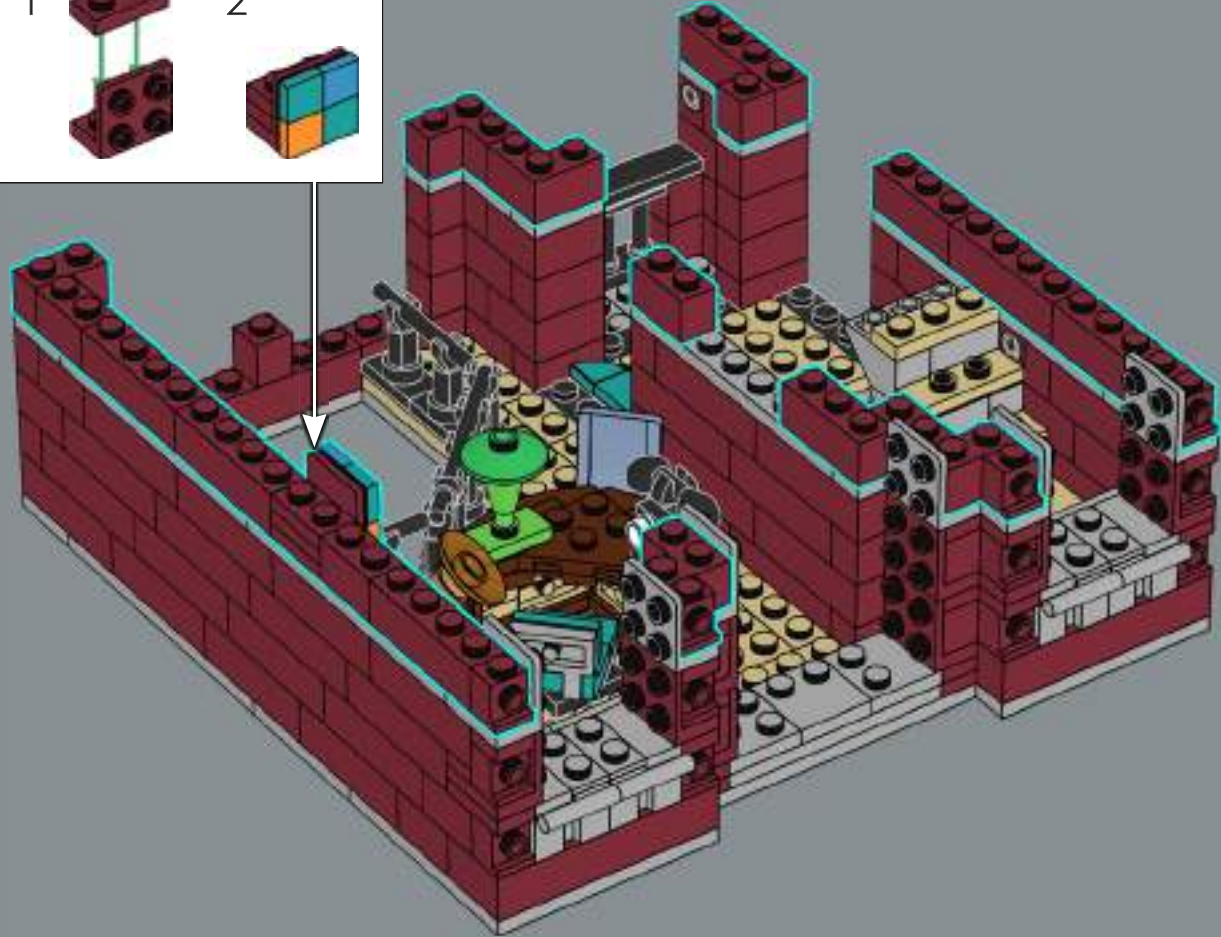

The wall art in the office is a small piece by the artist living in the loft above the LEGO® 10243 Parisian Restaurant.



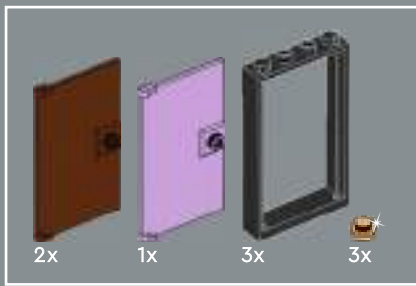

202

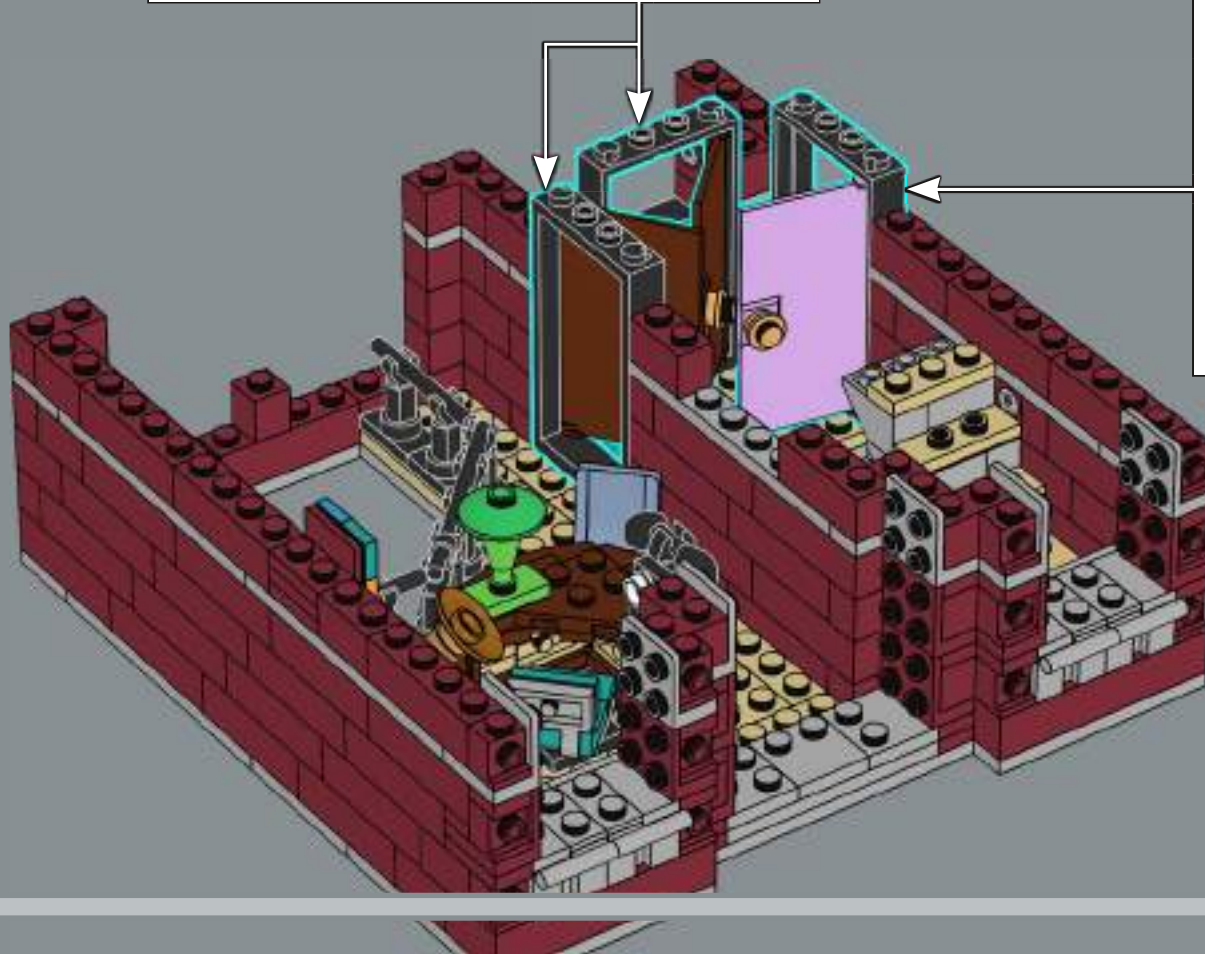
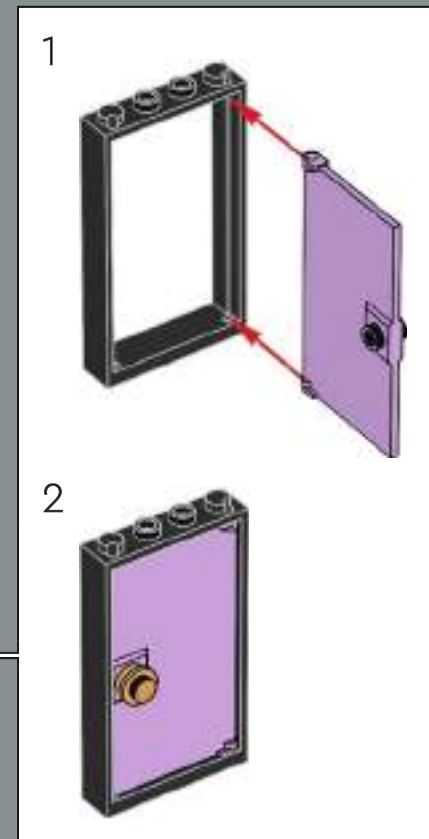
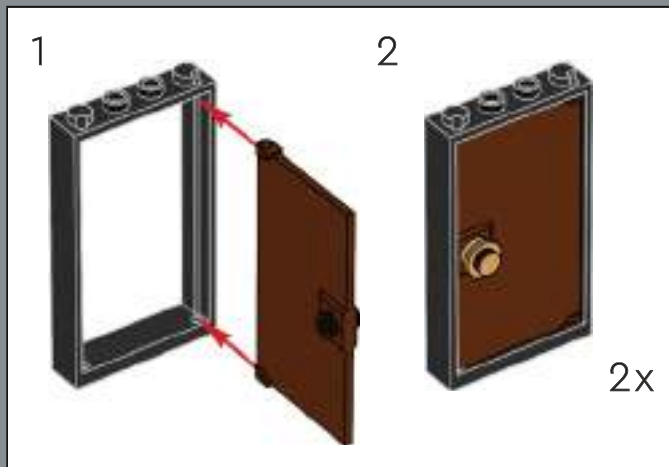



203

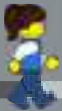
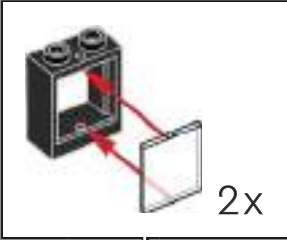
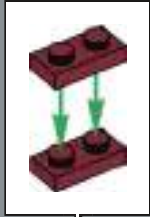
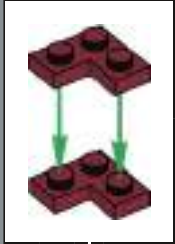

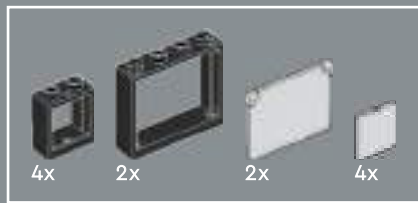

204

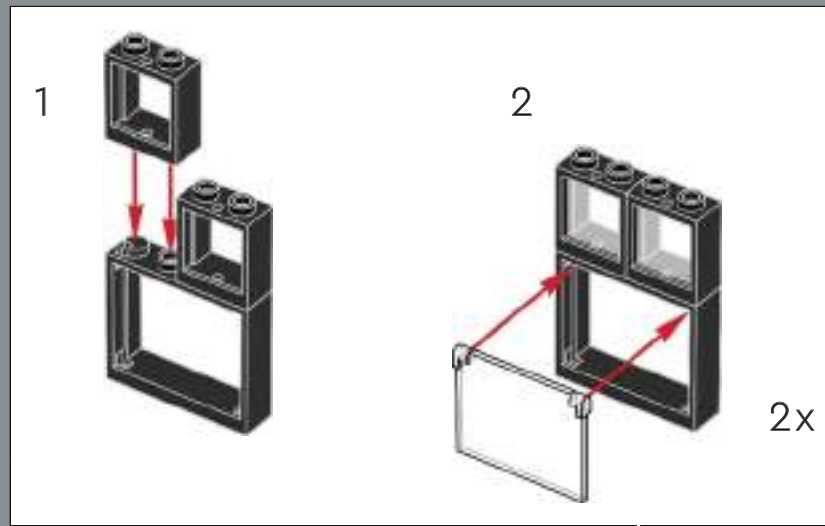

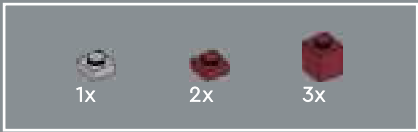

205

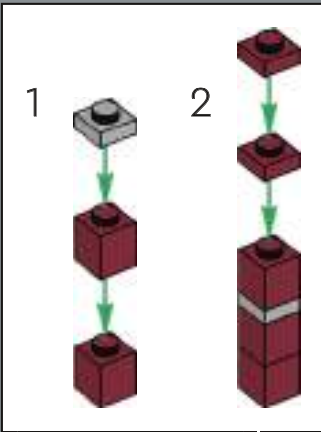

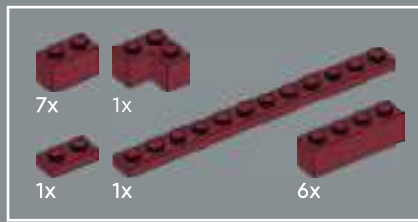

206





207

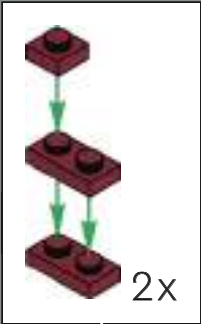

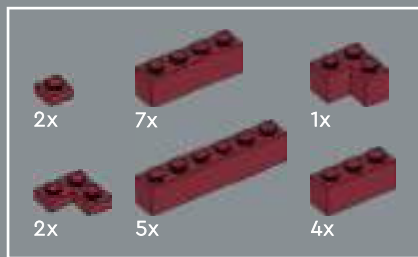

208

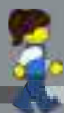



8x

209

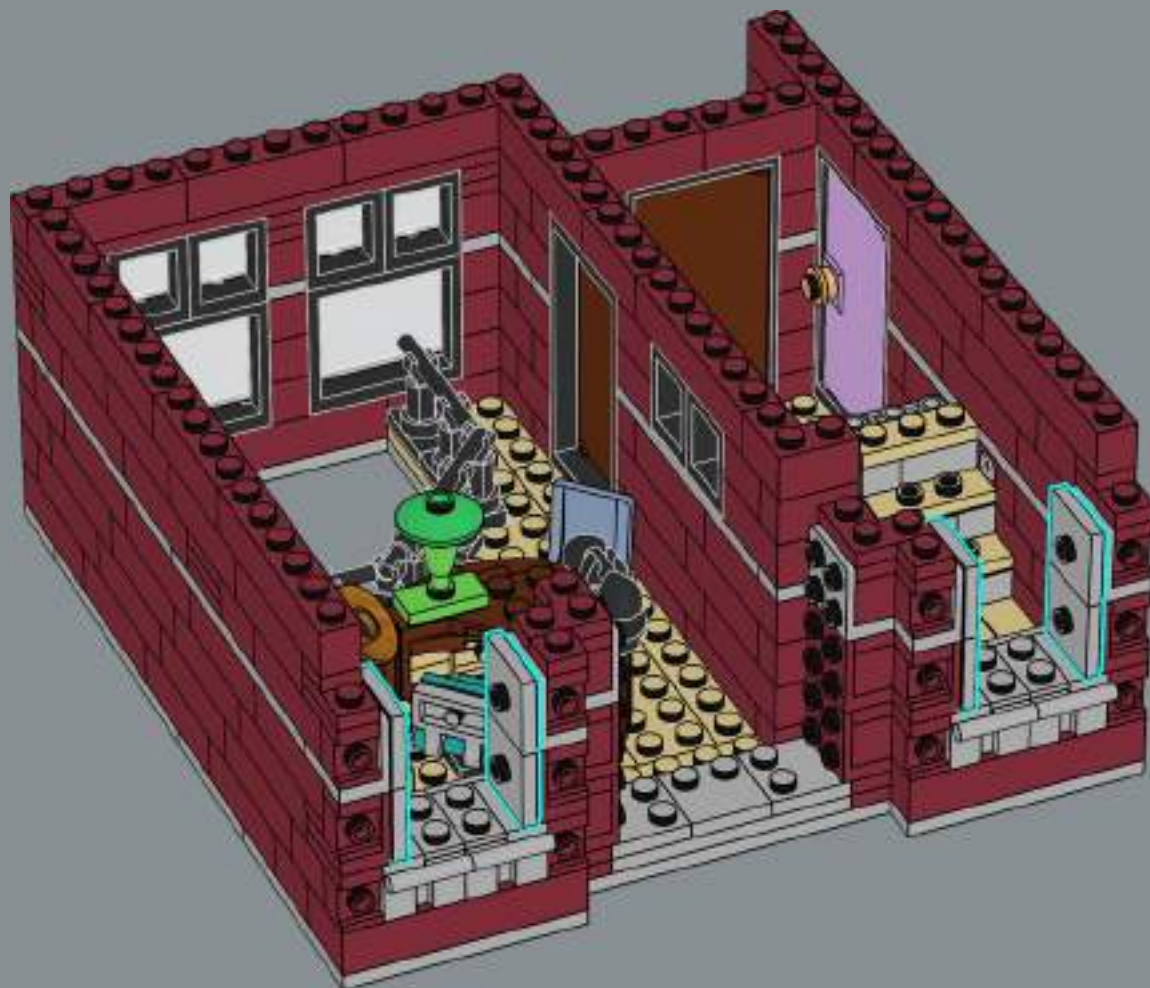



210

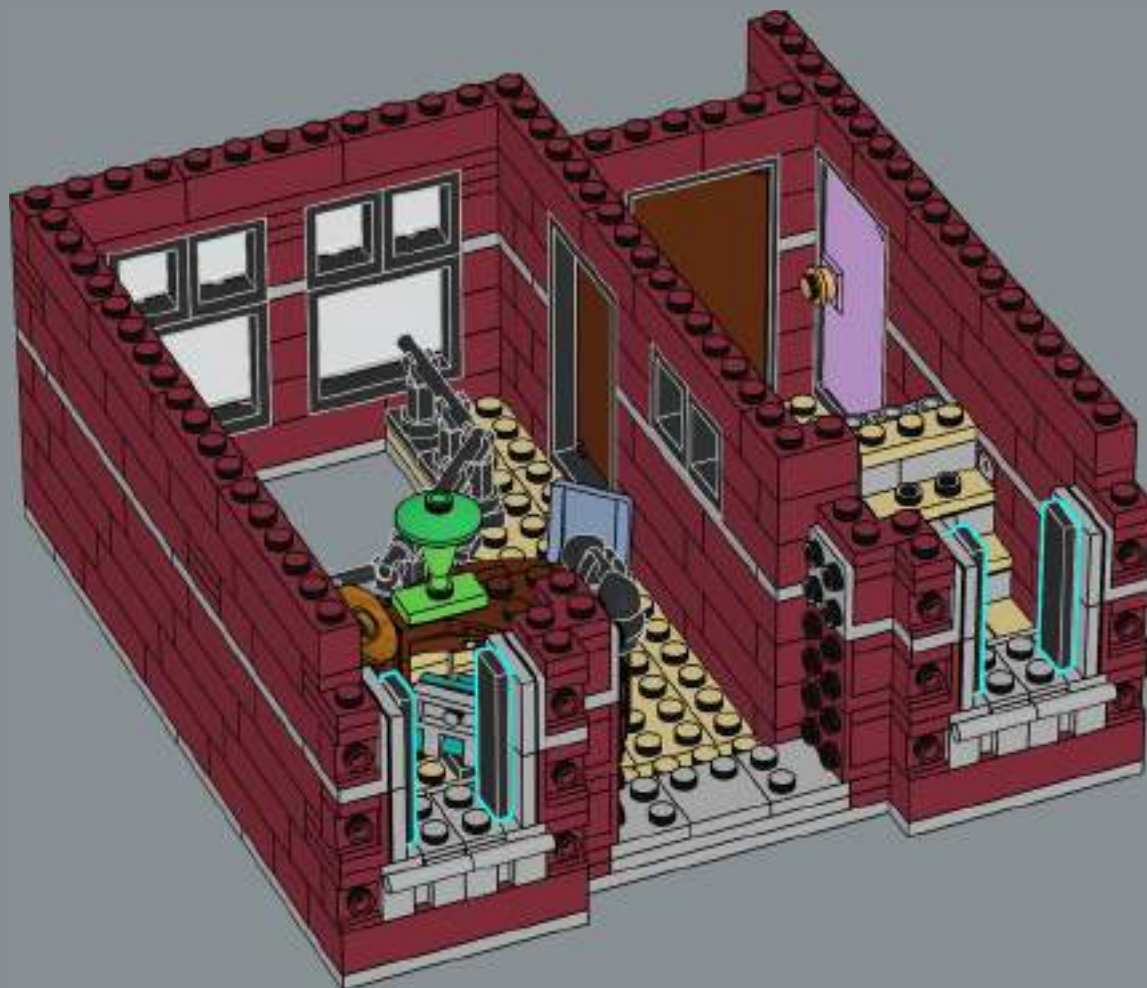



211

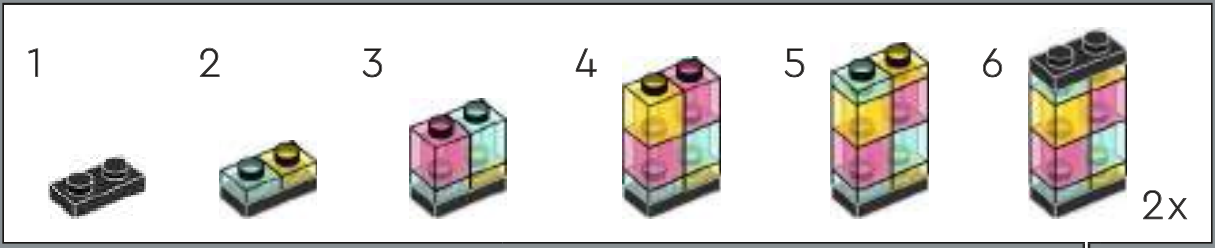

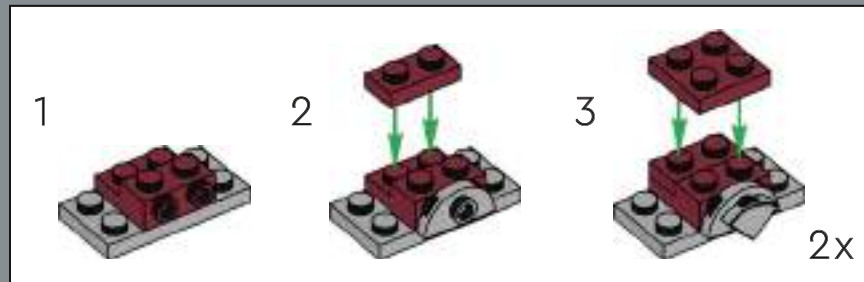
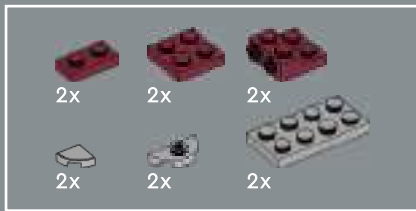

212

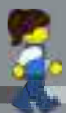
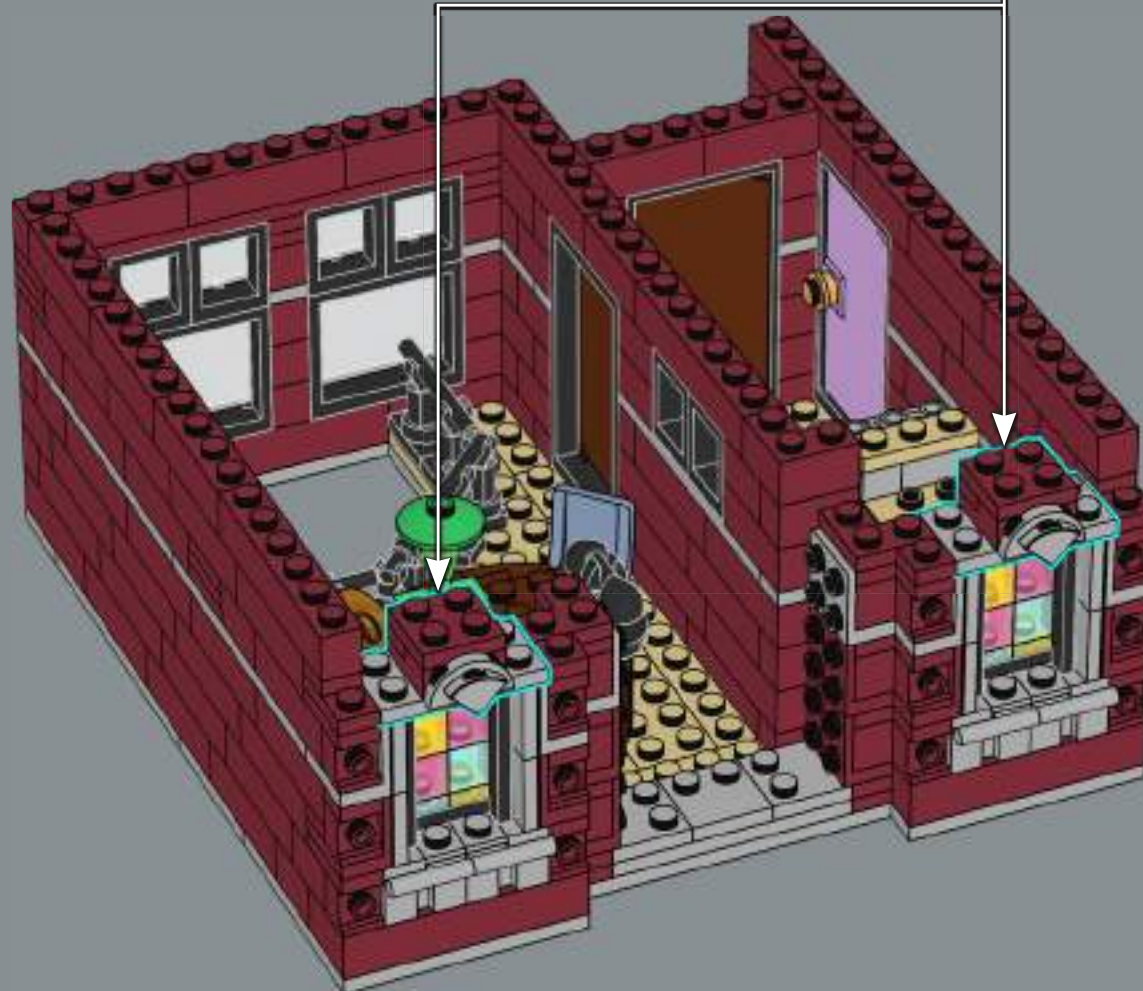



213

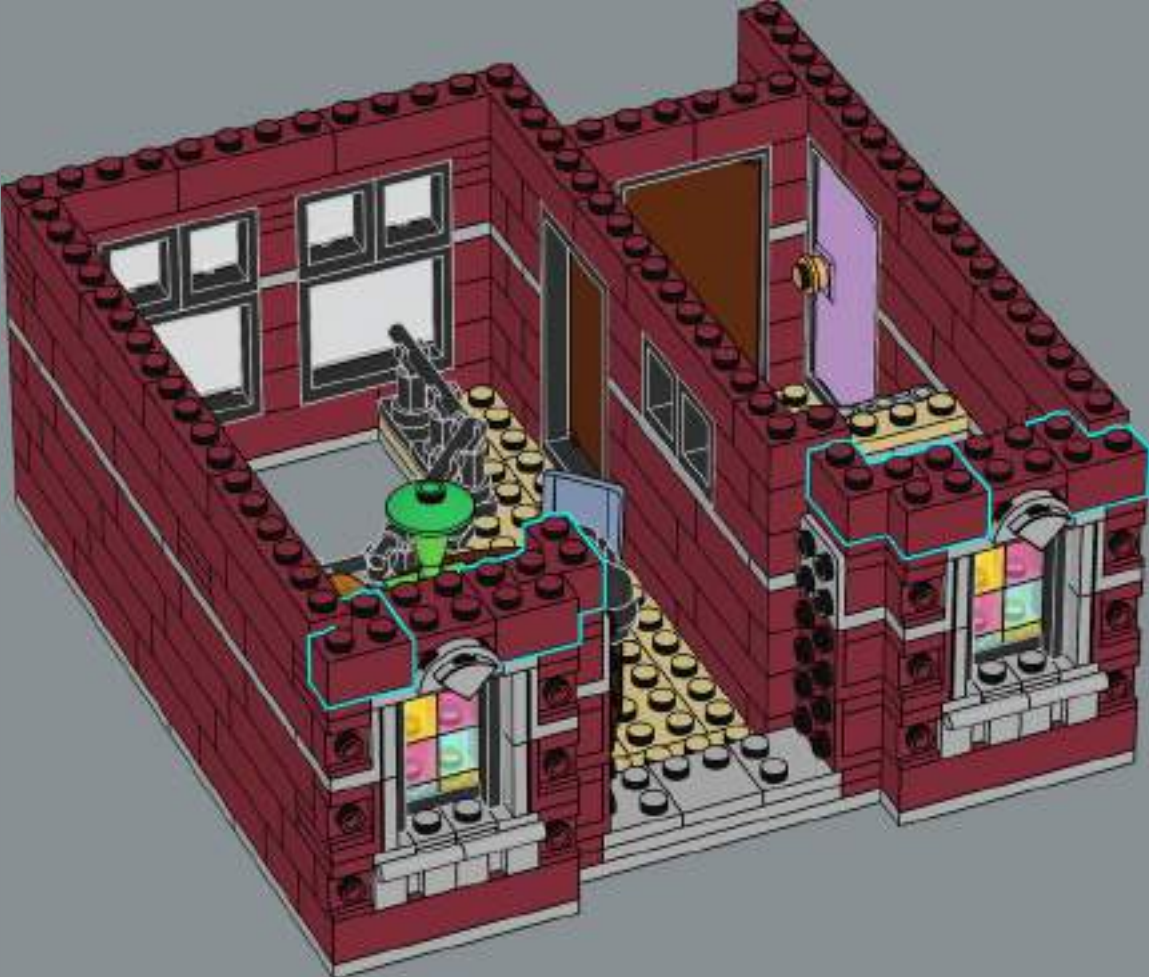



214

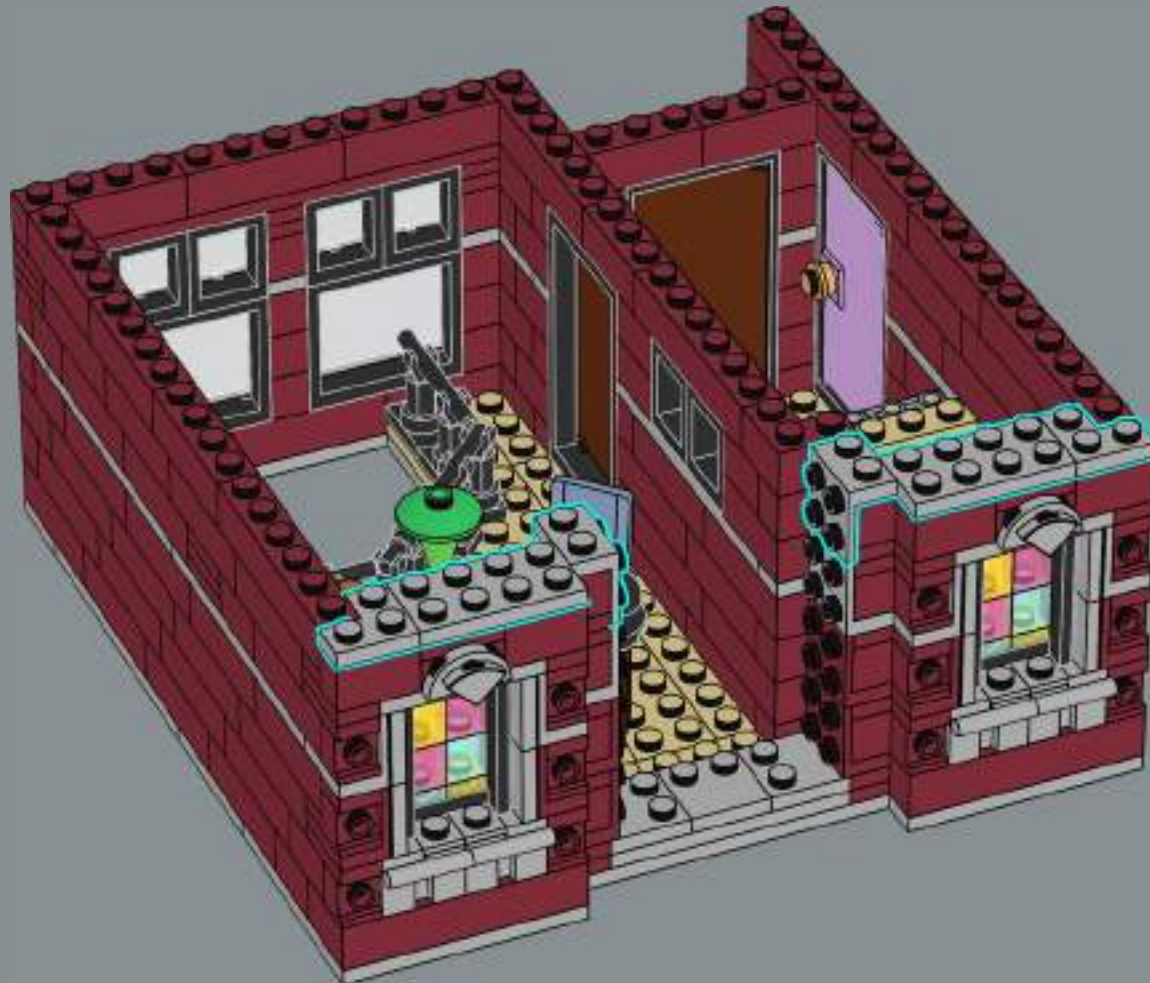



8x

215

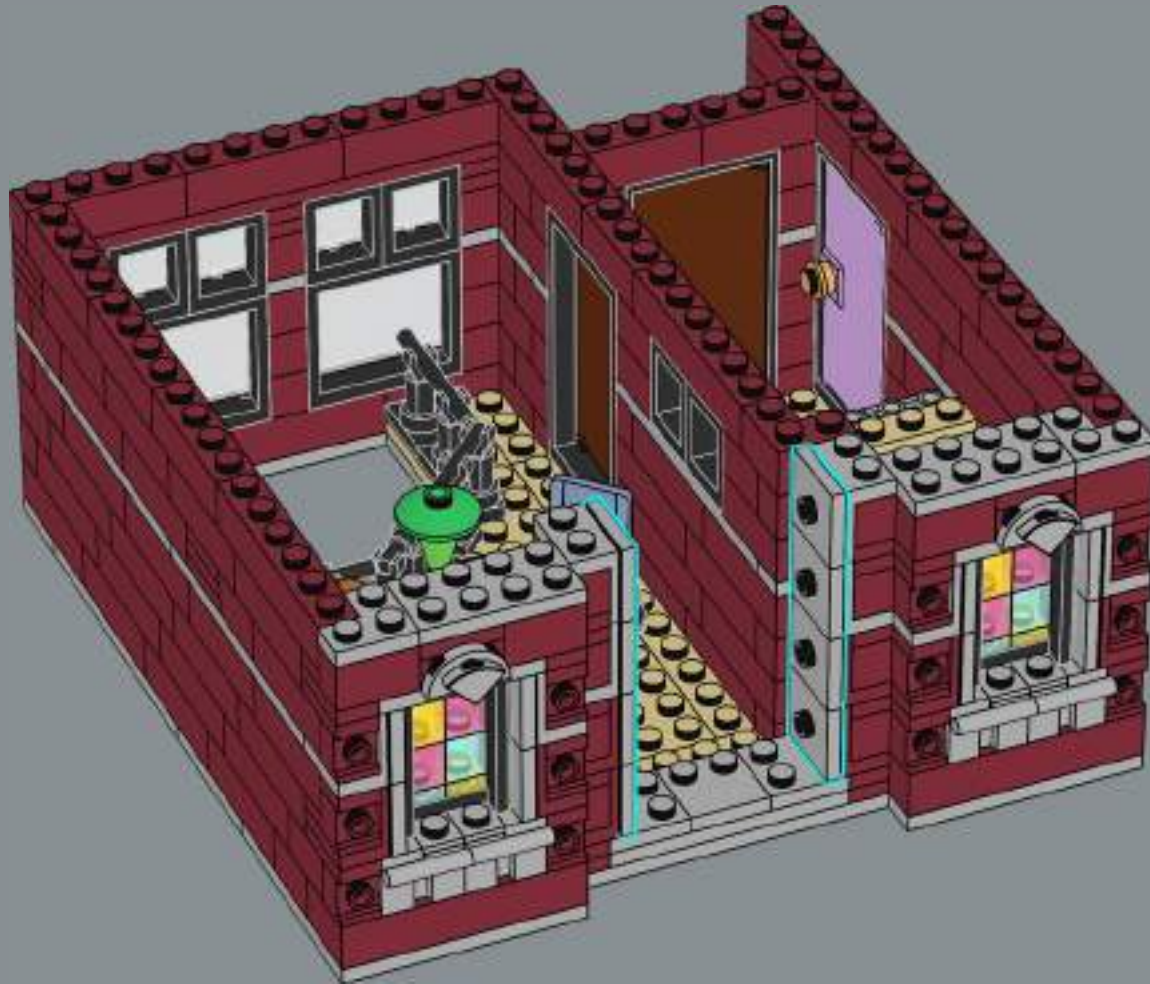



216

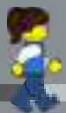



217

1

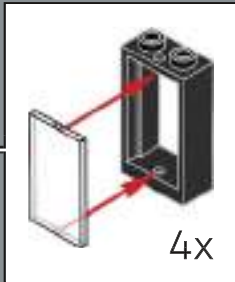
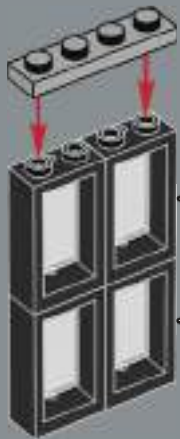

2

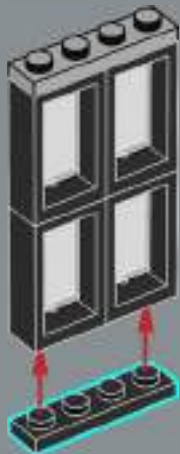

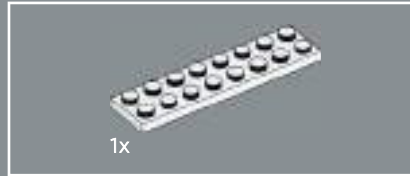
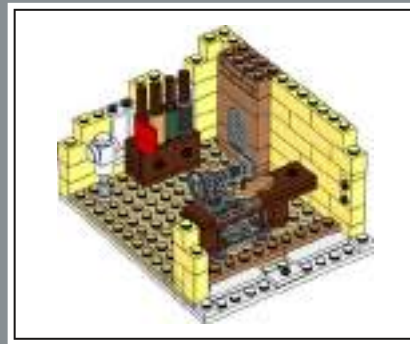

1x

218



1x

219

Have you purchased a new outfit at the LEGO® 10211 Grand Emporium, but it just doesn't fit right? Visit the tailor, who will be happy to assist you.

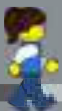
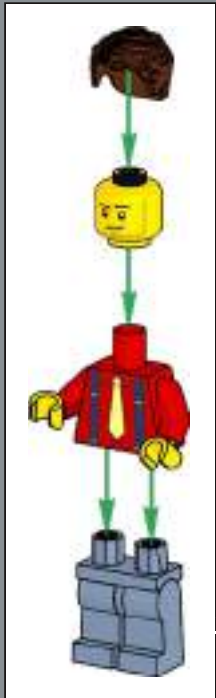
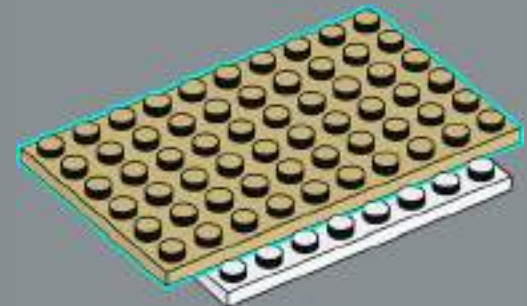
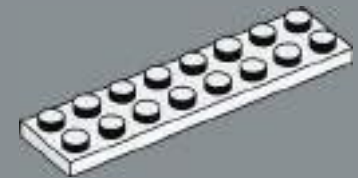



220

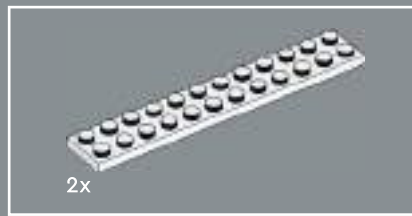
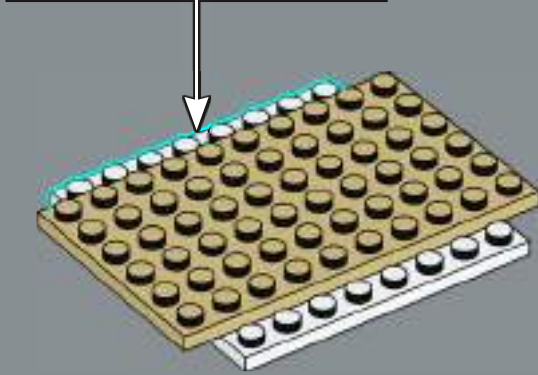
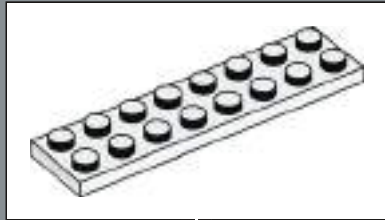

221

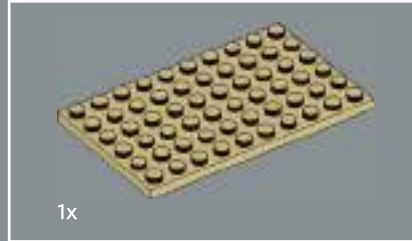
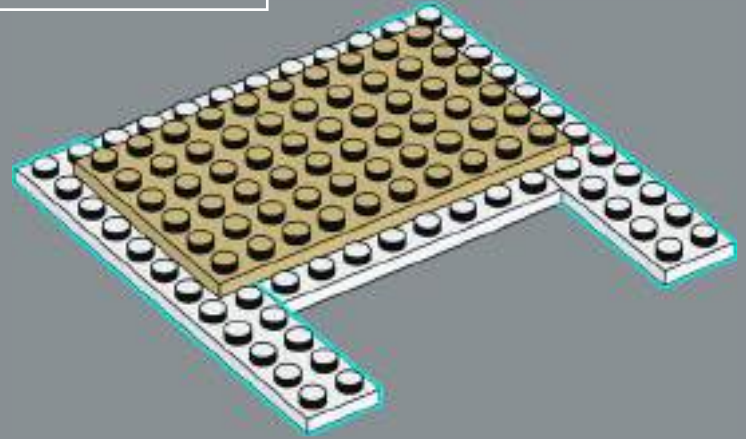

222

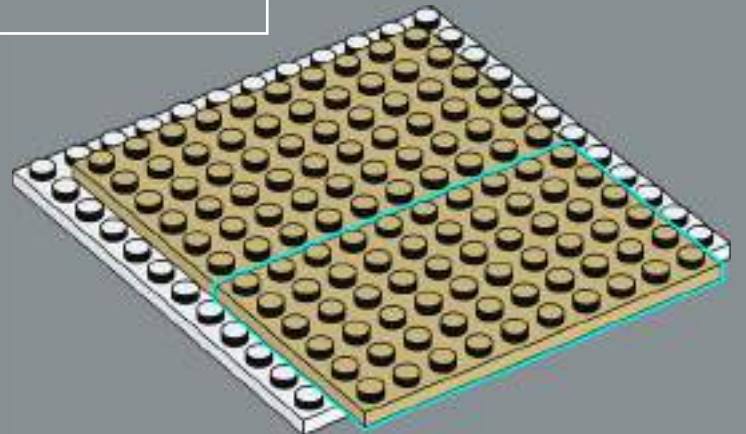

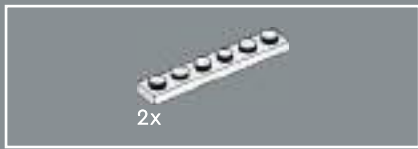

223

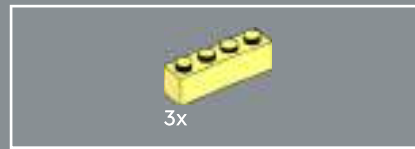
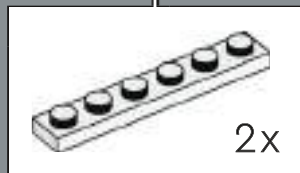
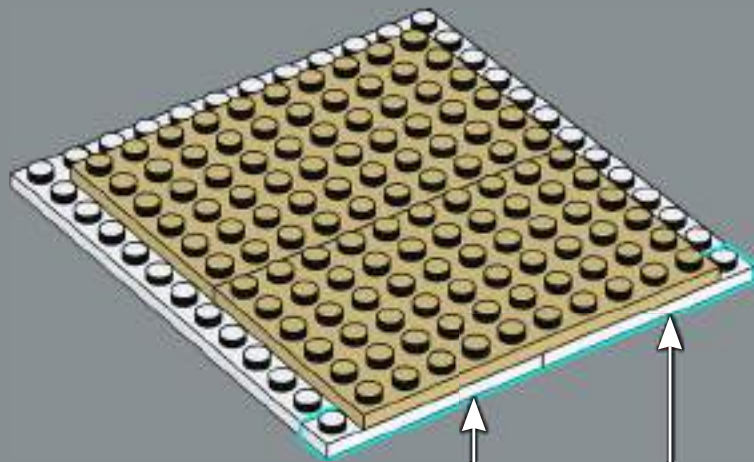

224

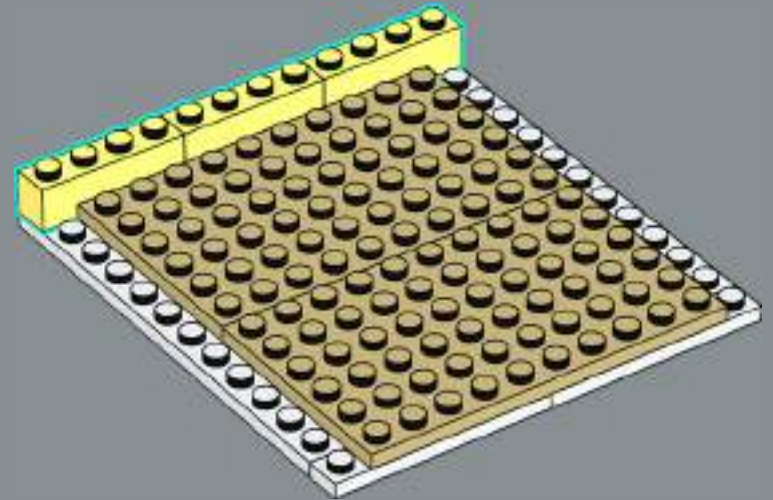

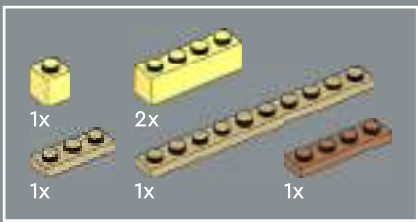

225

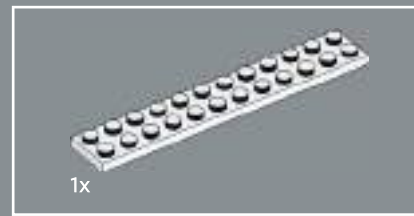
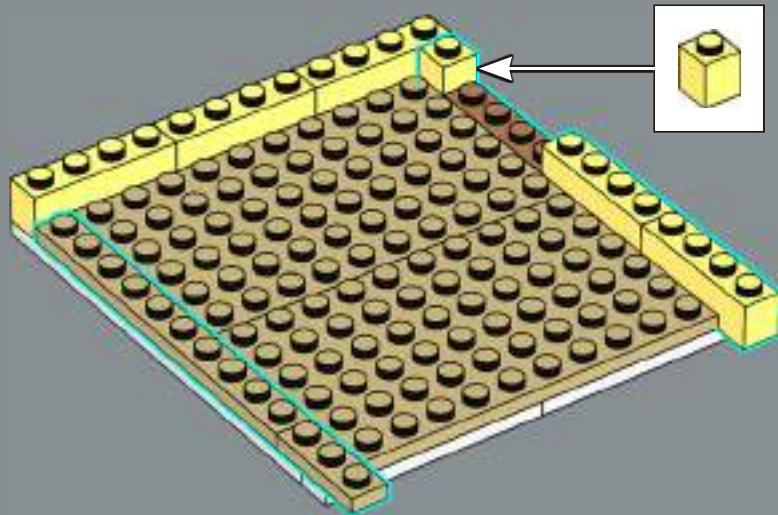

226

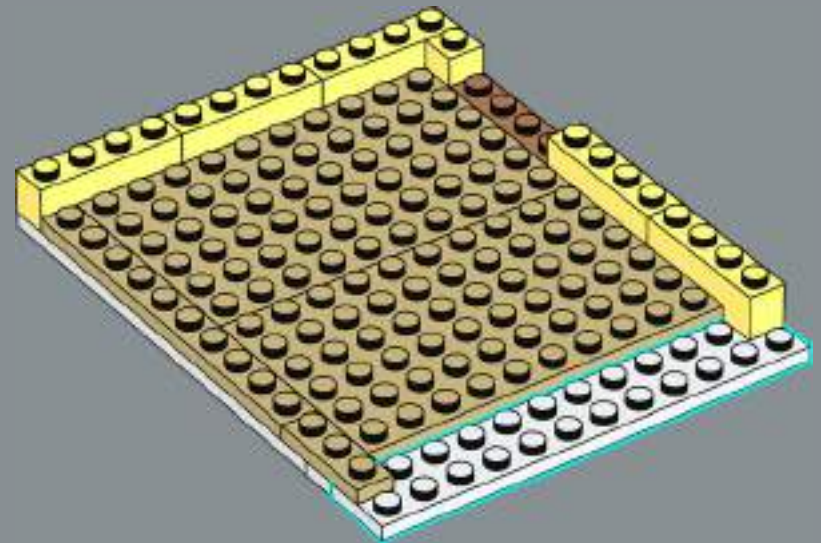

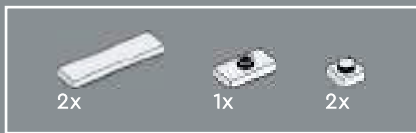

227

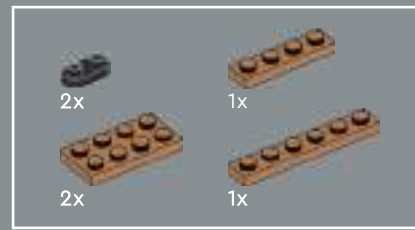
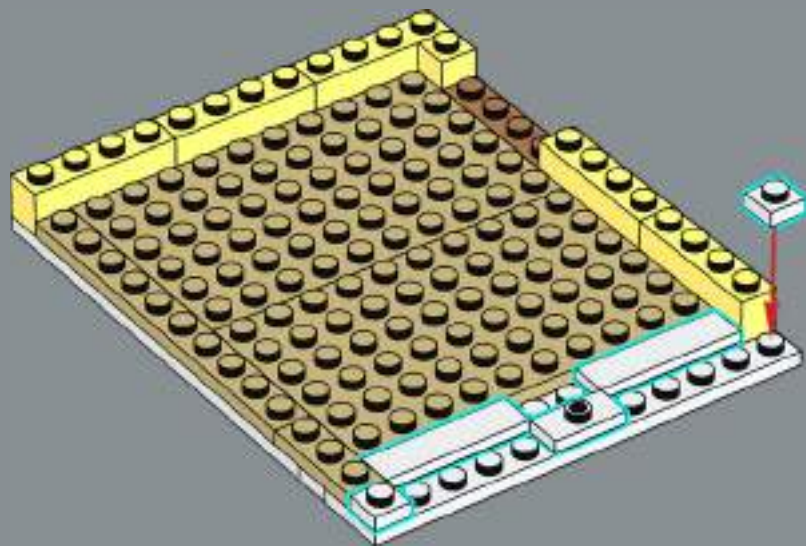

228

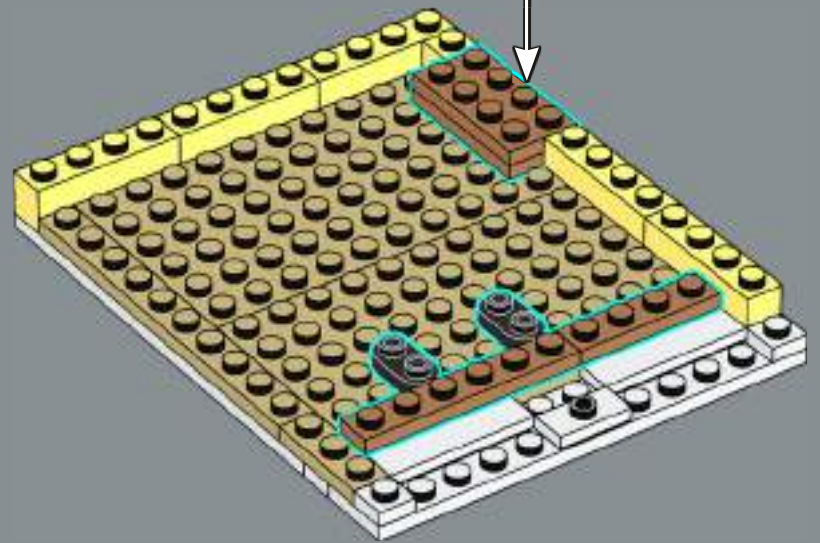
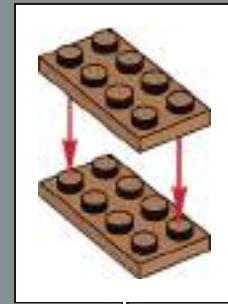

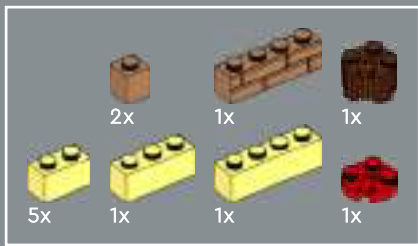

229



230



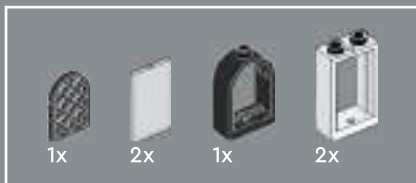

231

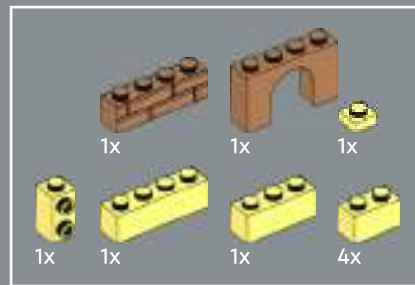
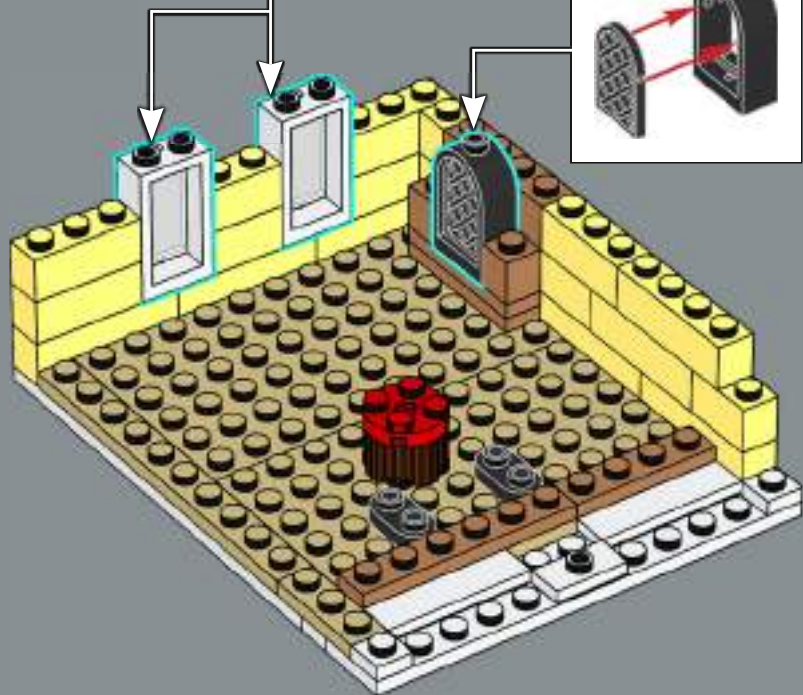
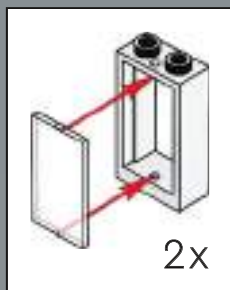

232

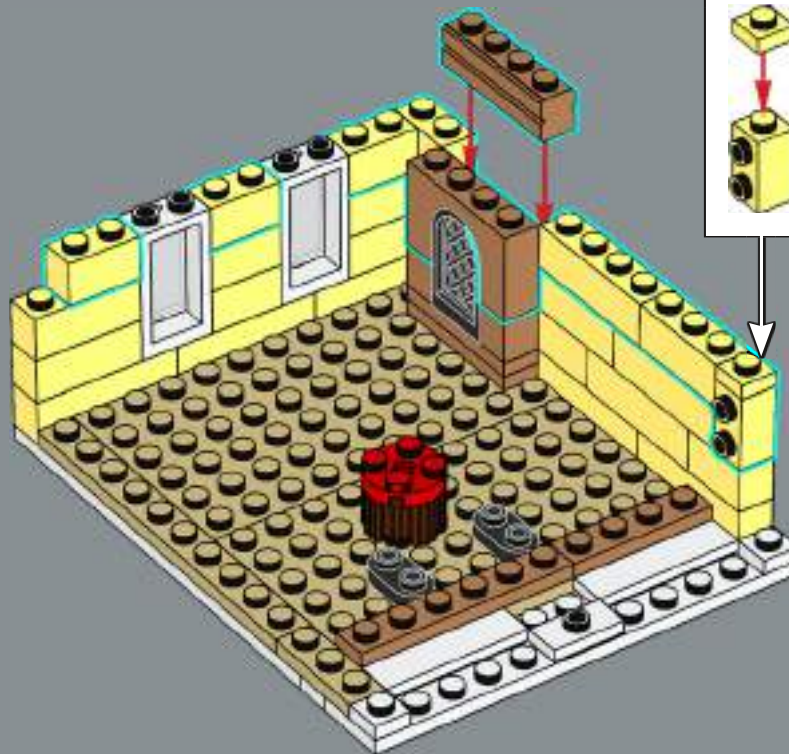



233

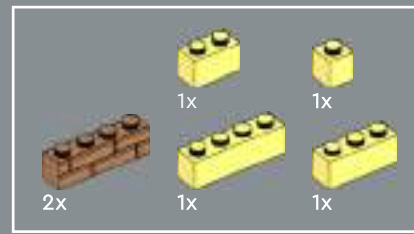
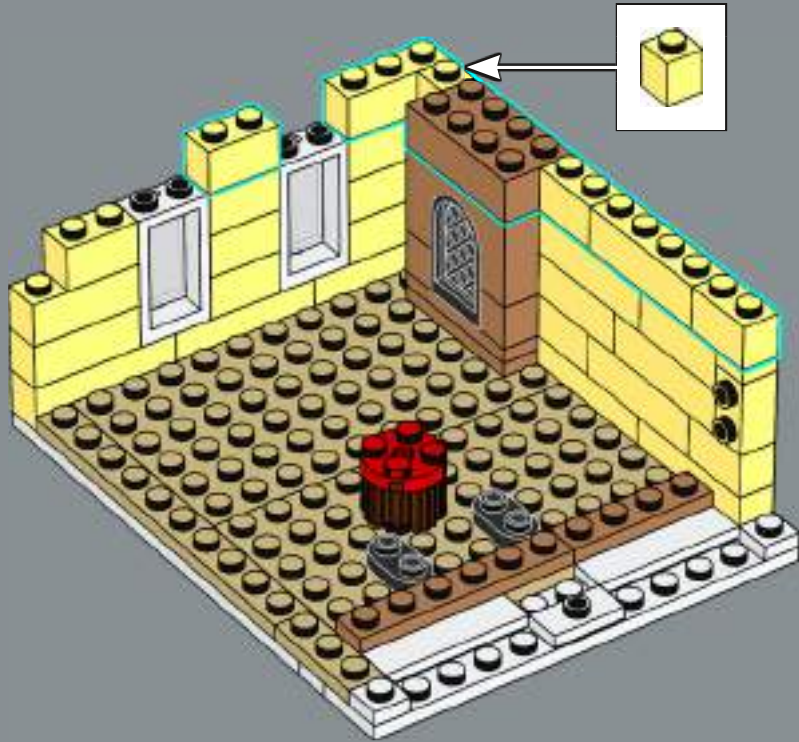

234

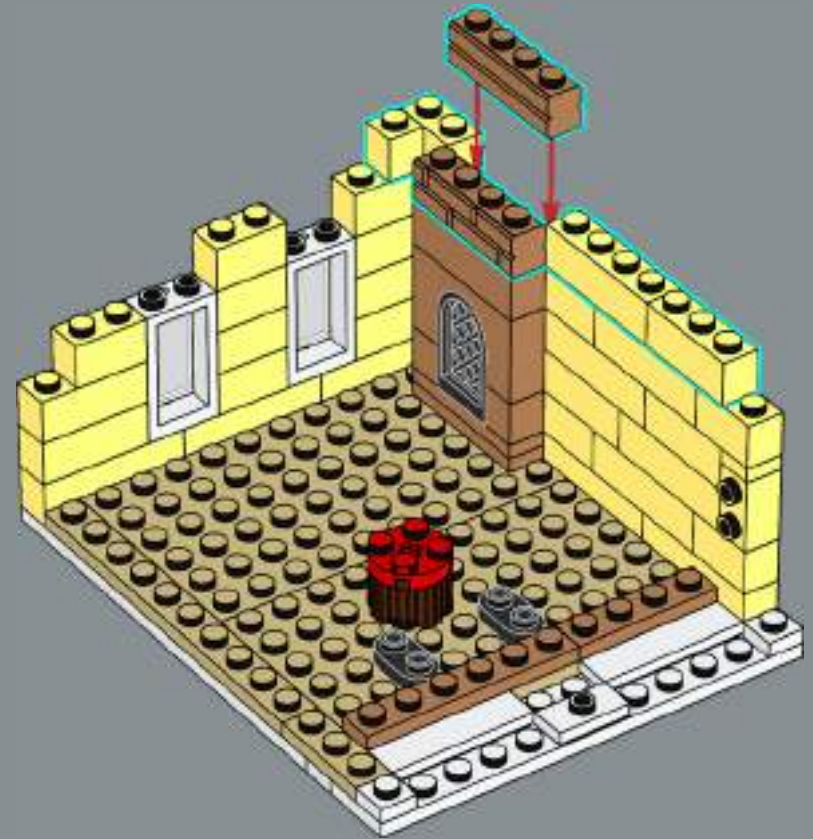

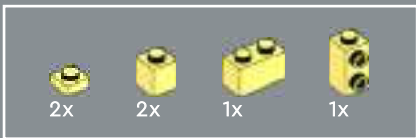

235

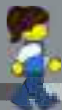
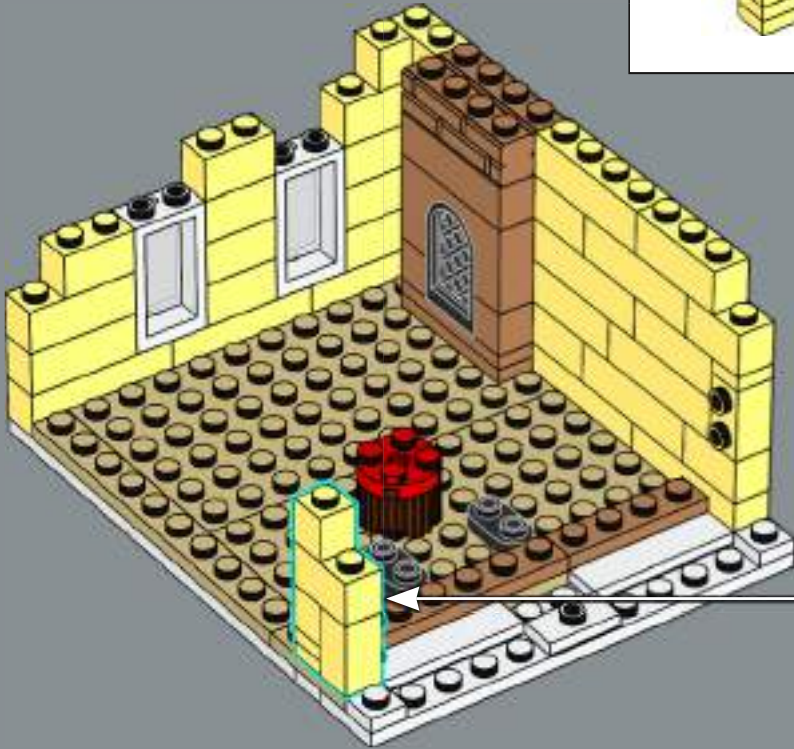
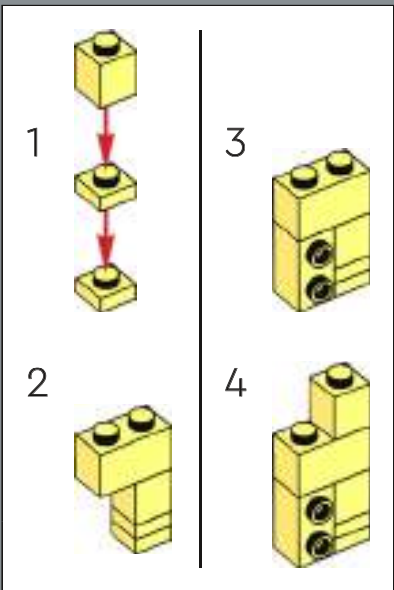



236

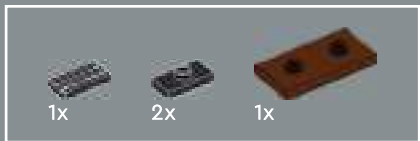

237

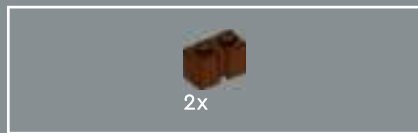
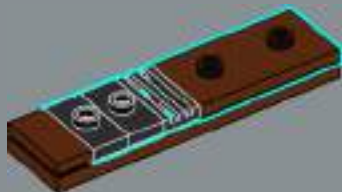

238

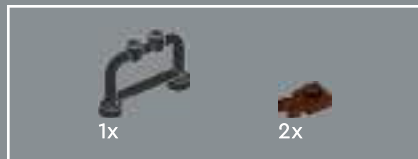
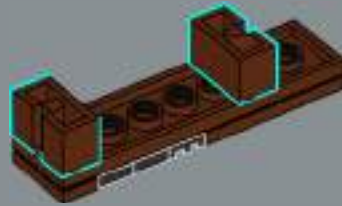

239

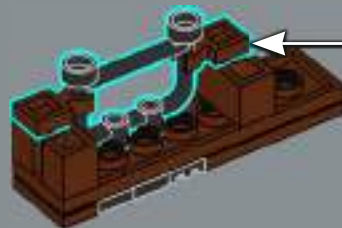
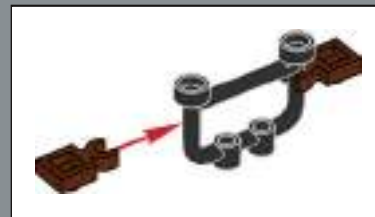

240

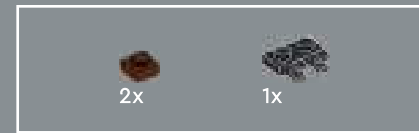
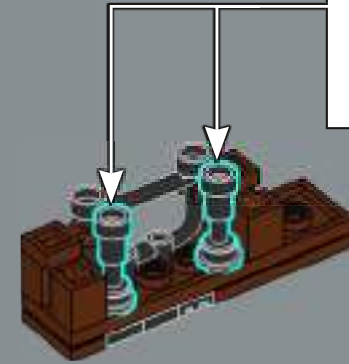
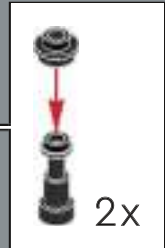

241

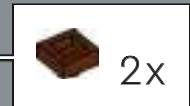



242

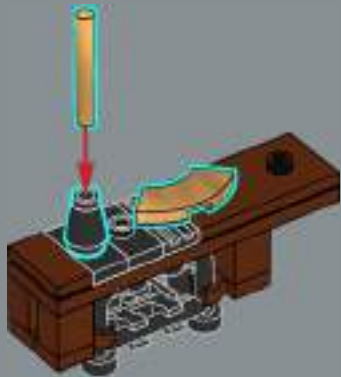

243

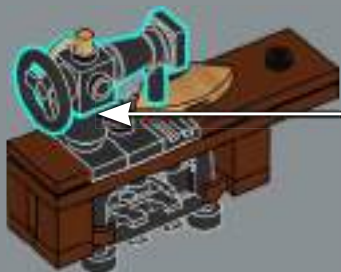

The tailor has just finished the singer's gown; golden thread and fabric are still left on the sewing machine!

244

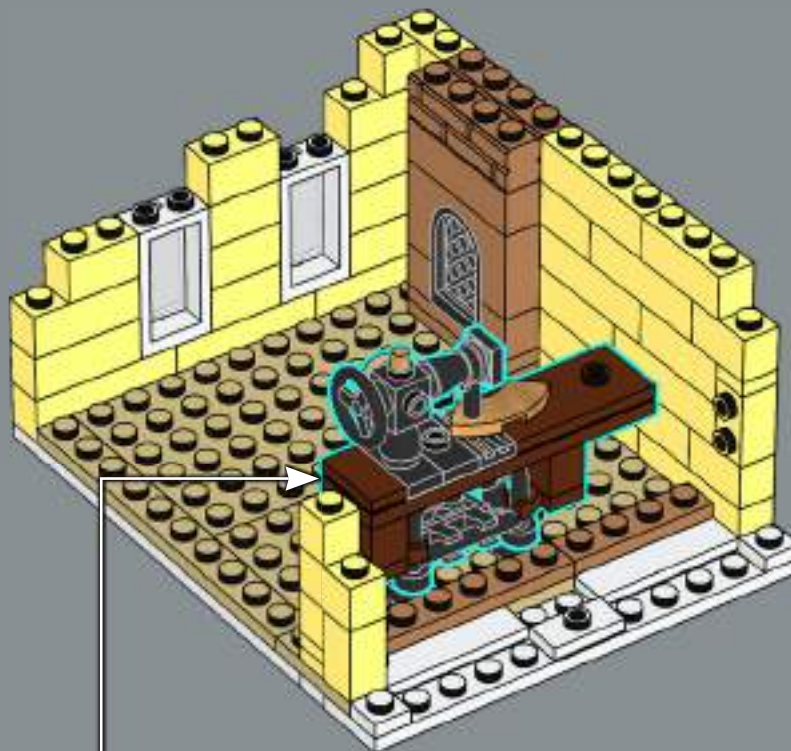



245

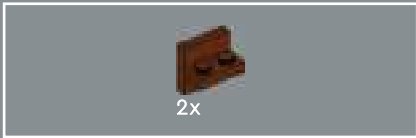

246



247



248

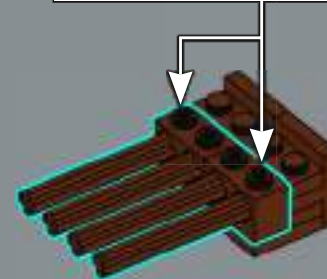
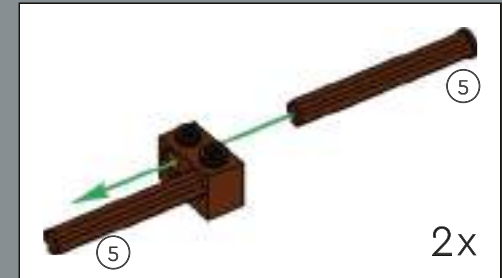



249

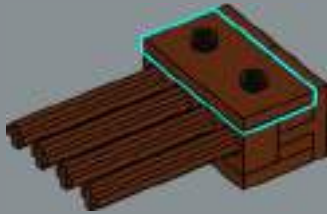

250

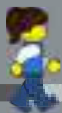
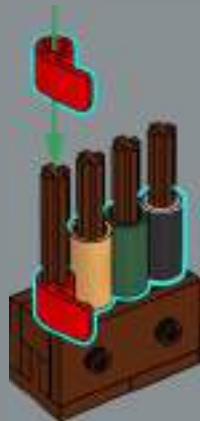

The elements making up the red cloth first appeared as elements in LEGO® Technic sets.

251

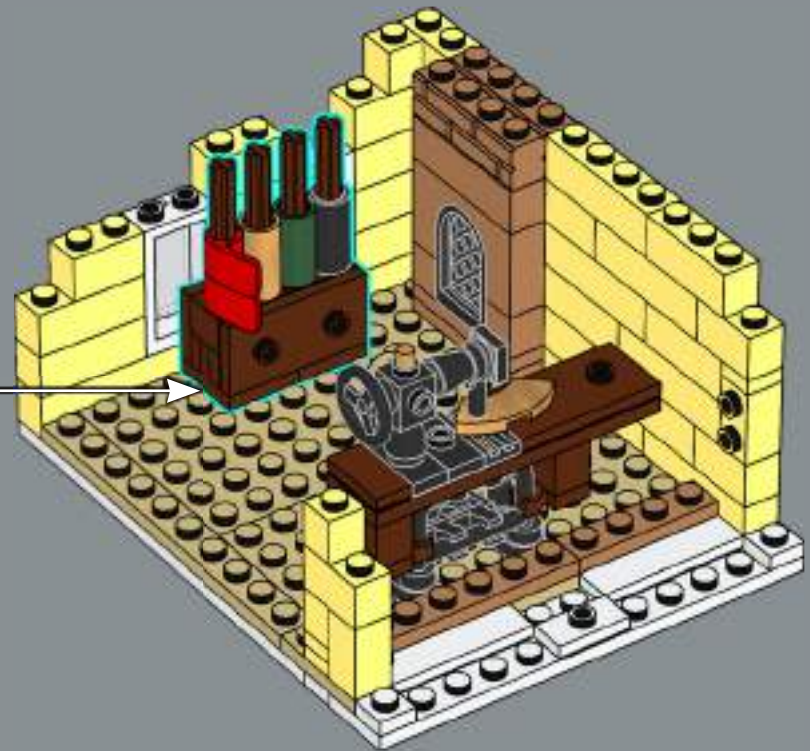



252

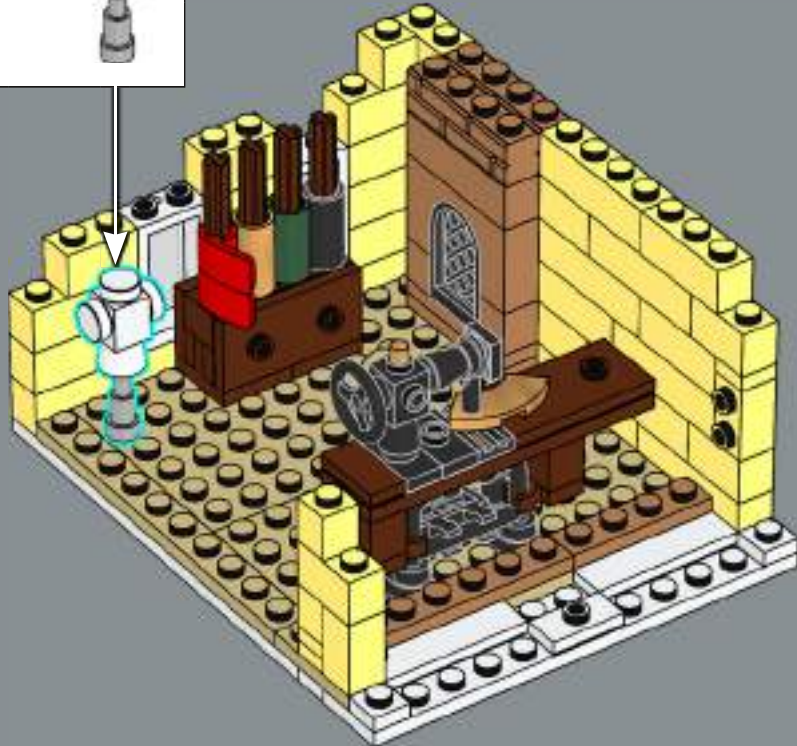
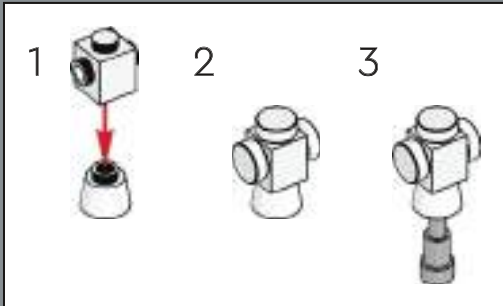

253

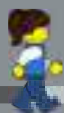

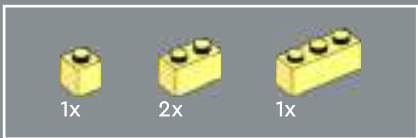

254

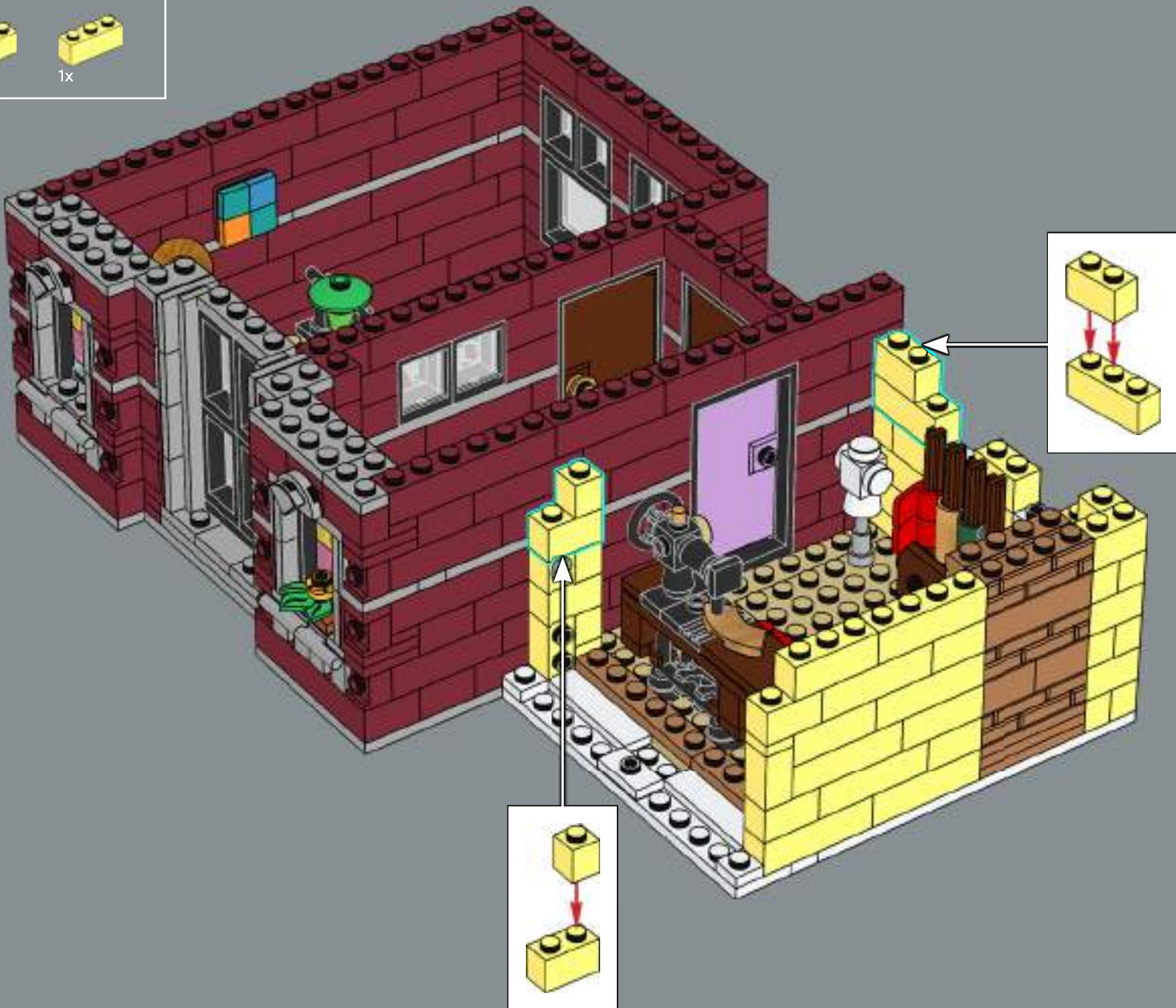



255

1

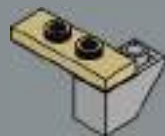

2

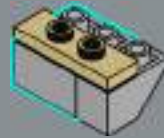

3

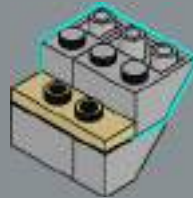

4

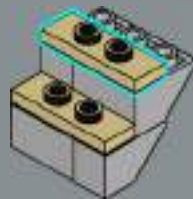

5

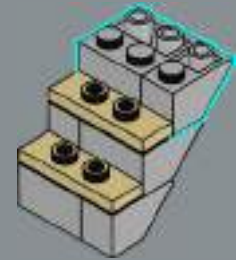

6

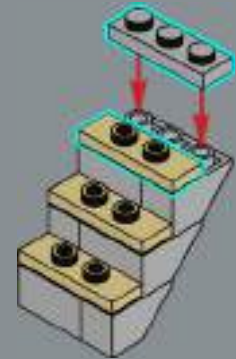

7

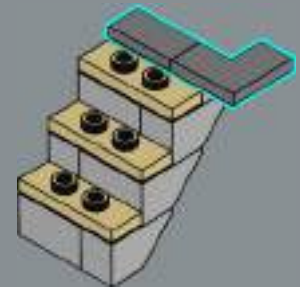





12x

256

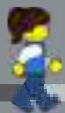



257

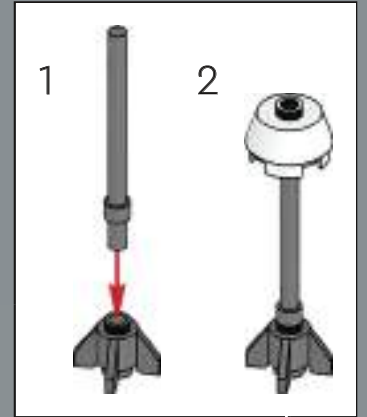
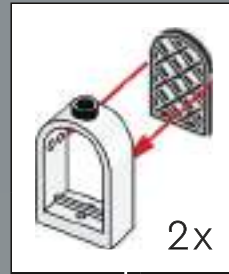

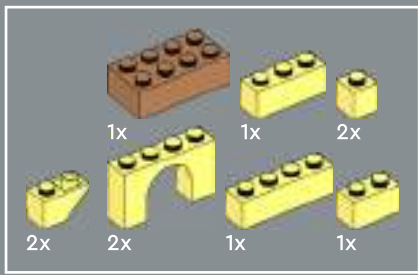

258





259

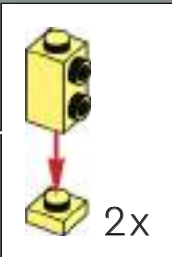

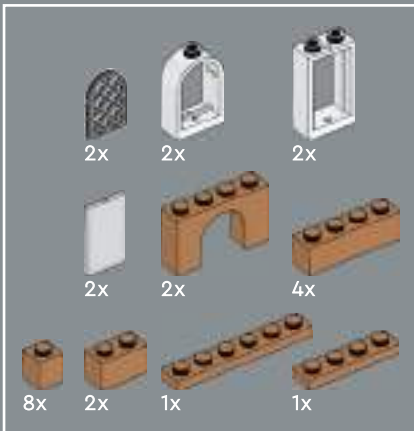

260

1



2

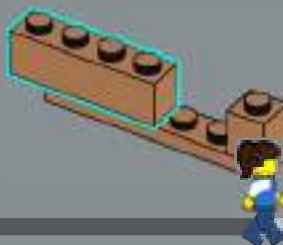

3

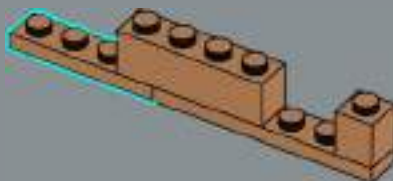

4

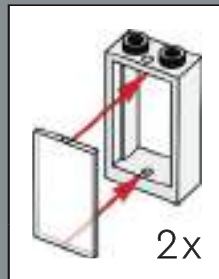
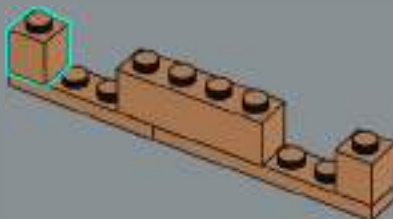

5

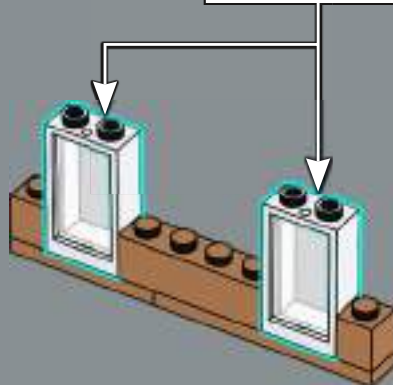

6

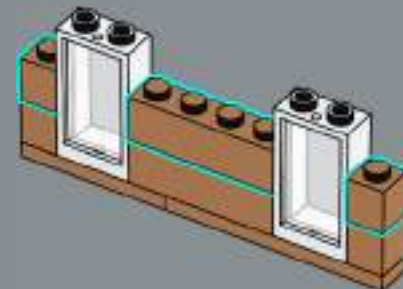

7

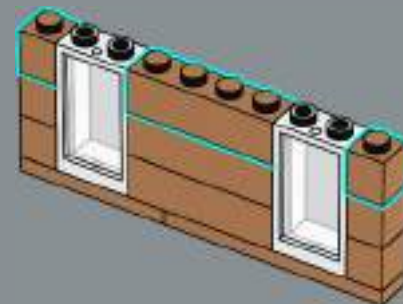

8

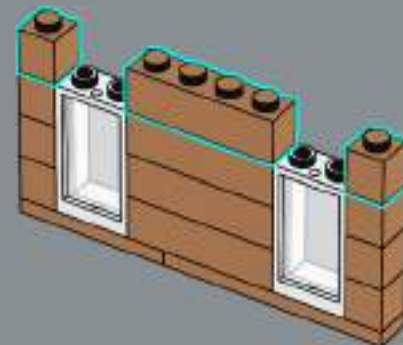

9

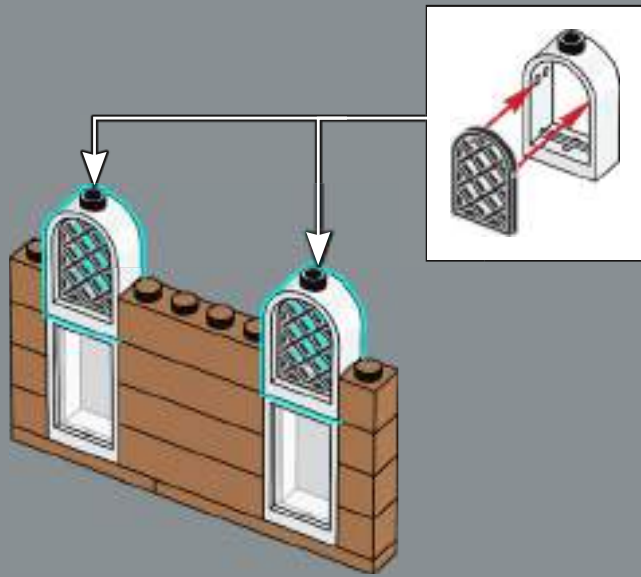

10

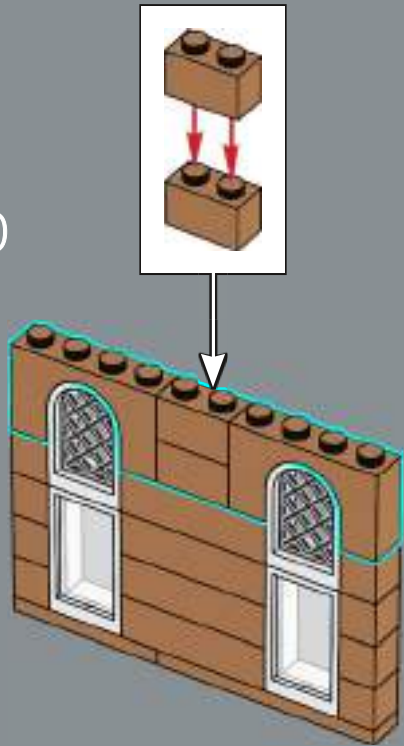



261

1



2



3

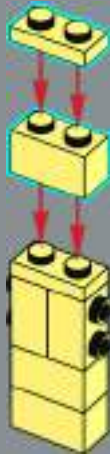

4





262



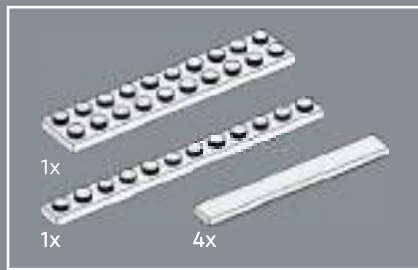

263

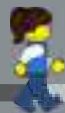

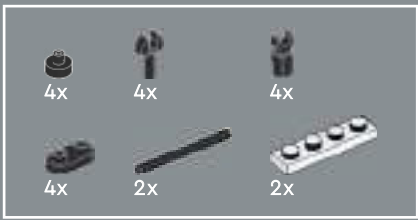

264

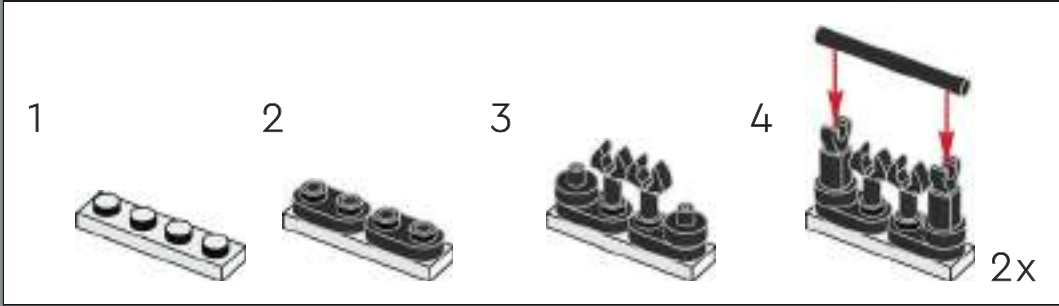



265

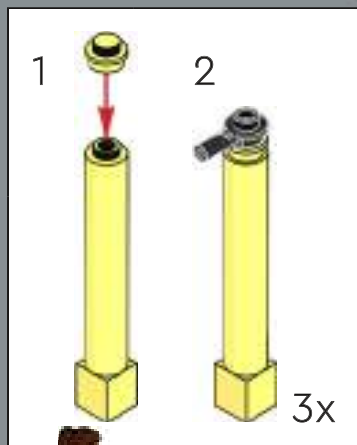



3x

266

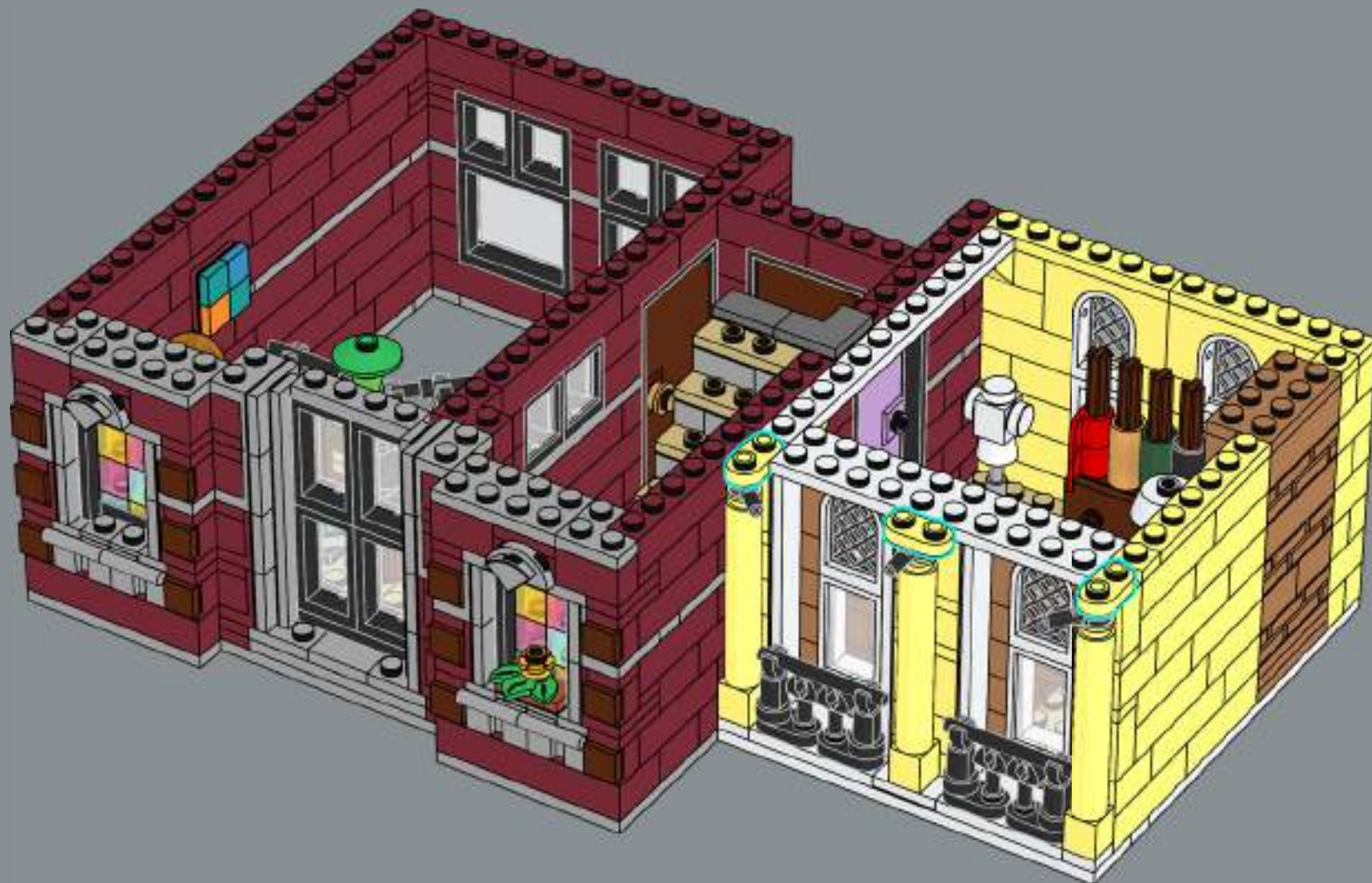

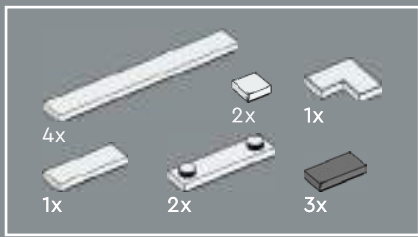

267

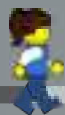

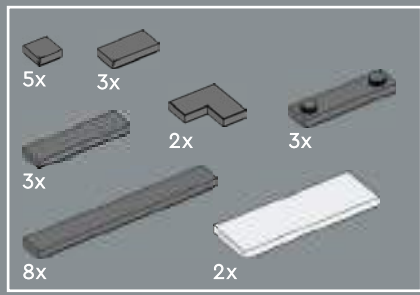

268





269



Lavender hanging flowers, a lavender sign, lavender doors... if you need to visit the tailor, just follow the lavender!

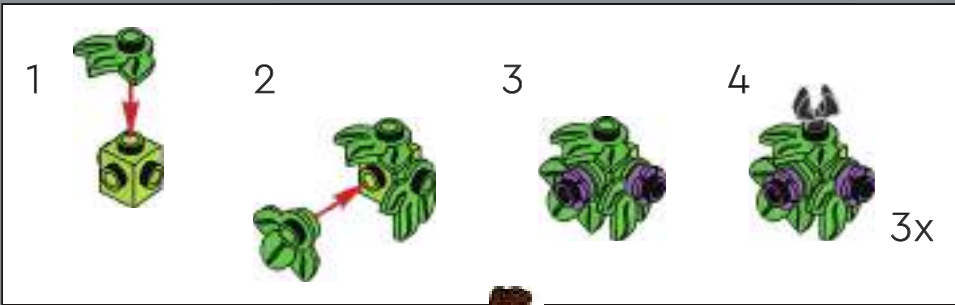

270





The singer is nearly ready for tonight's show. She has picked up her dress from the tailor, had a bite to eat at the Pizzeria, checked in with the manager and now she is warming up in the dressing room.

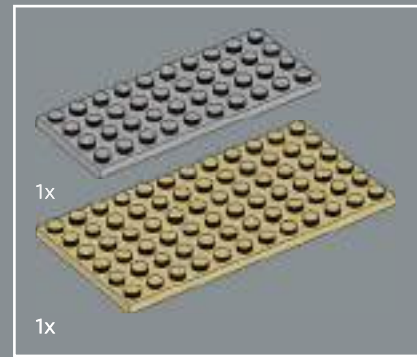

271

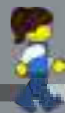
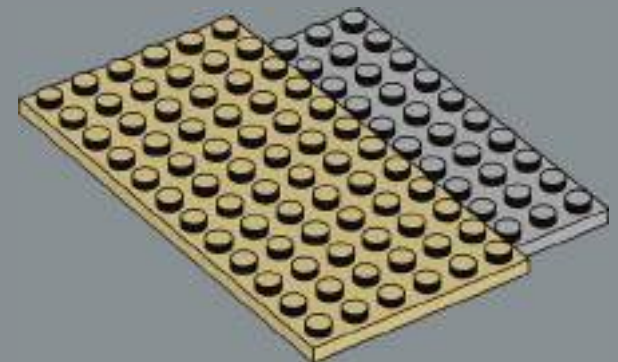
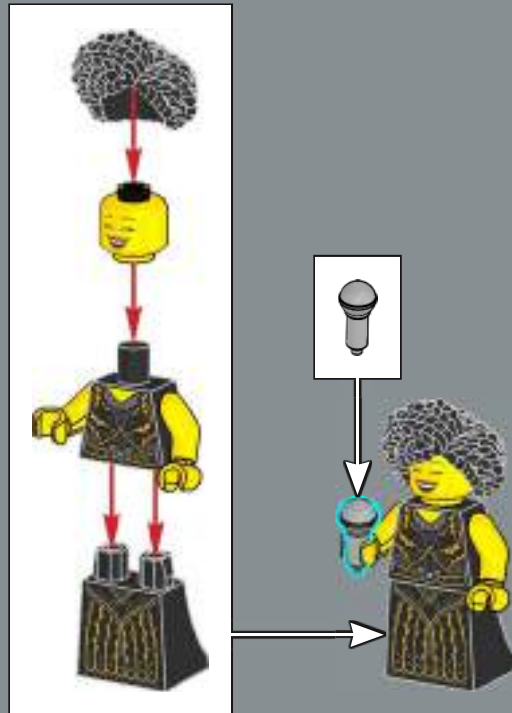

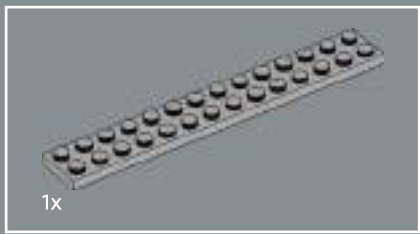

272

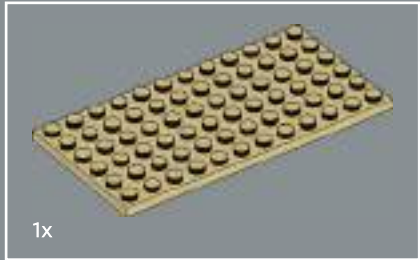
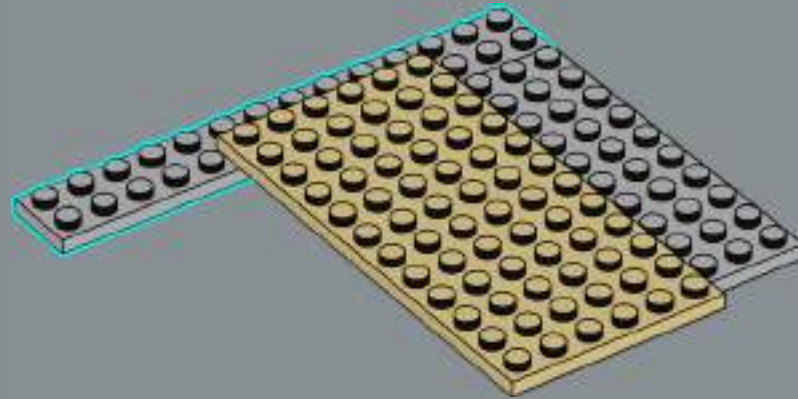

273

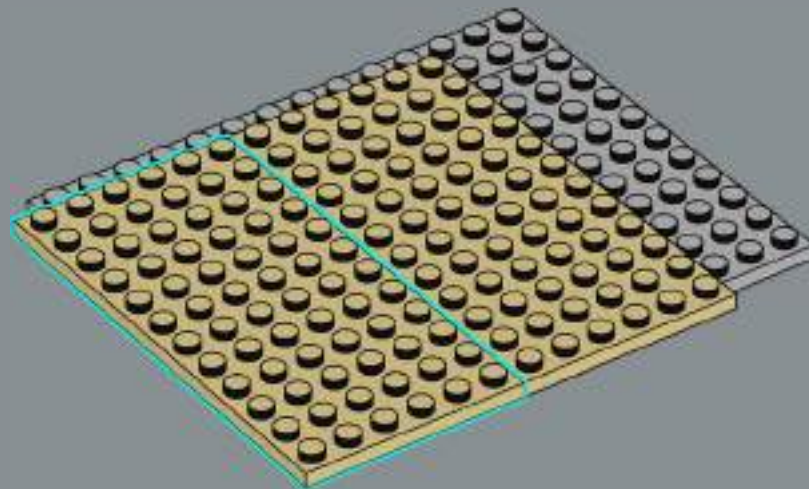

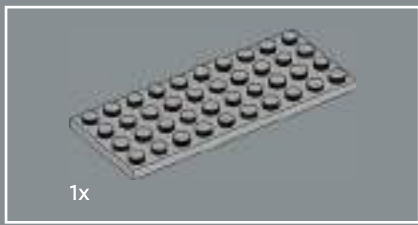

274

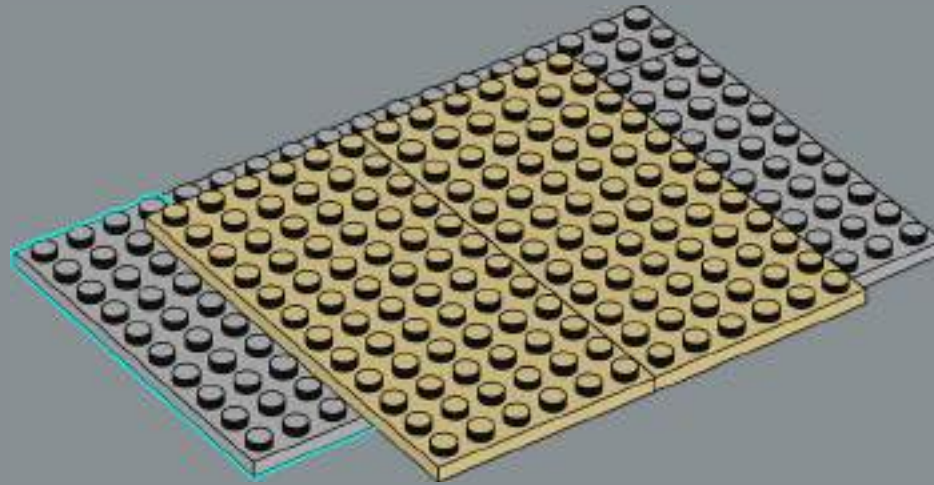

275

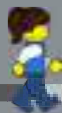
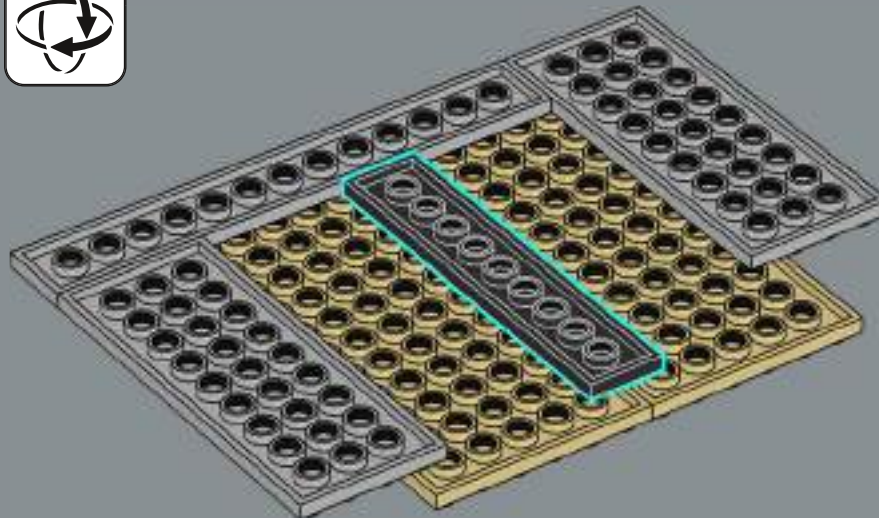



276

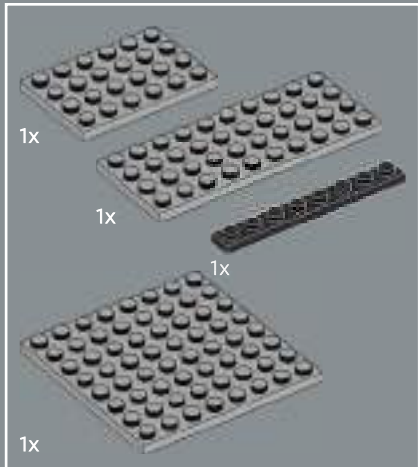
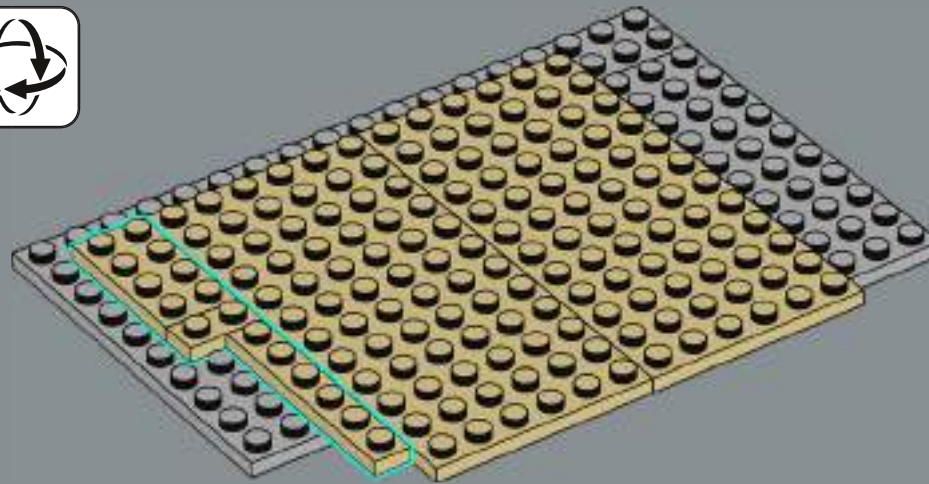

277

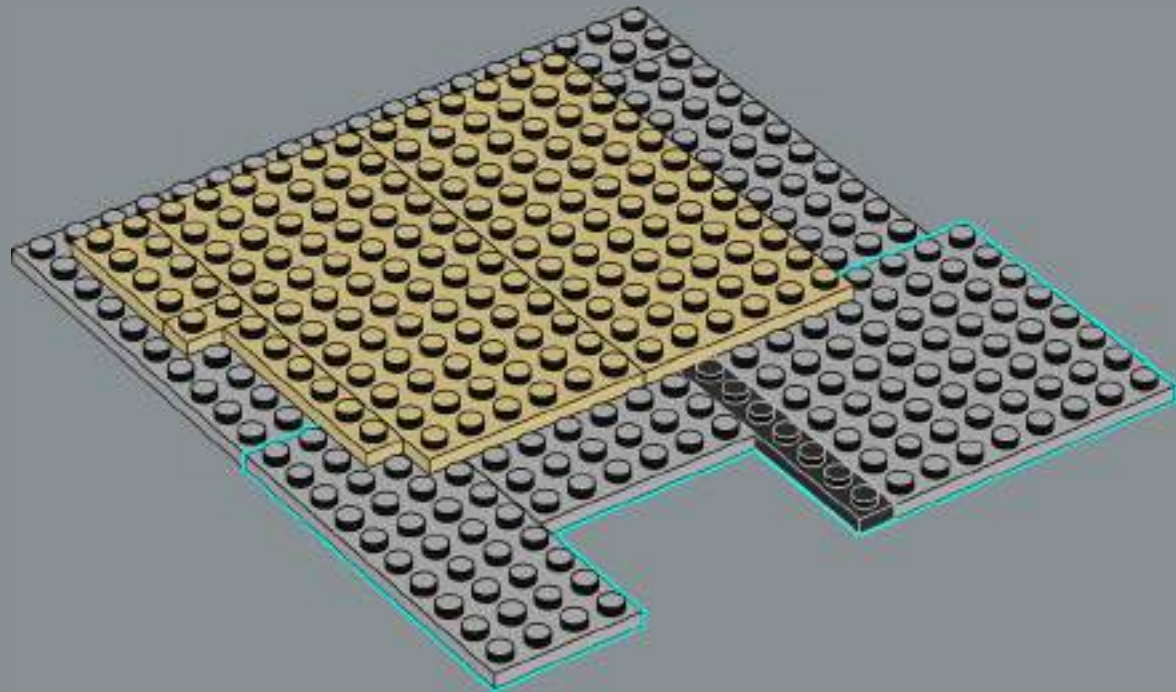

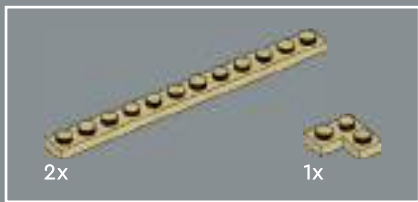

278

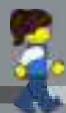
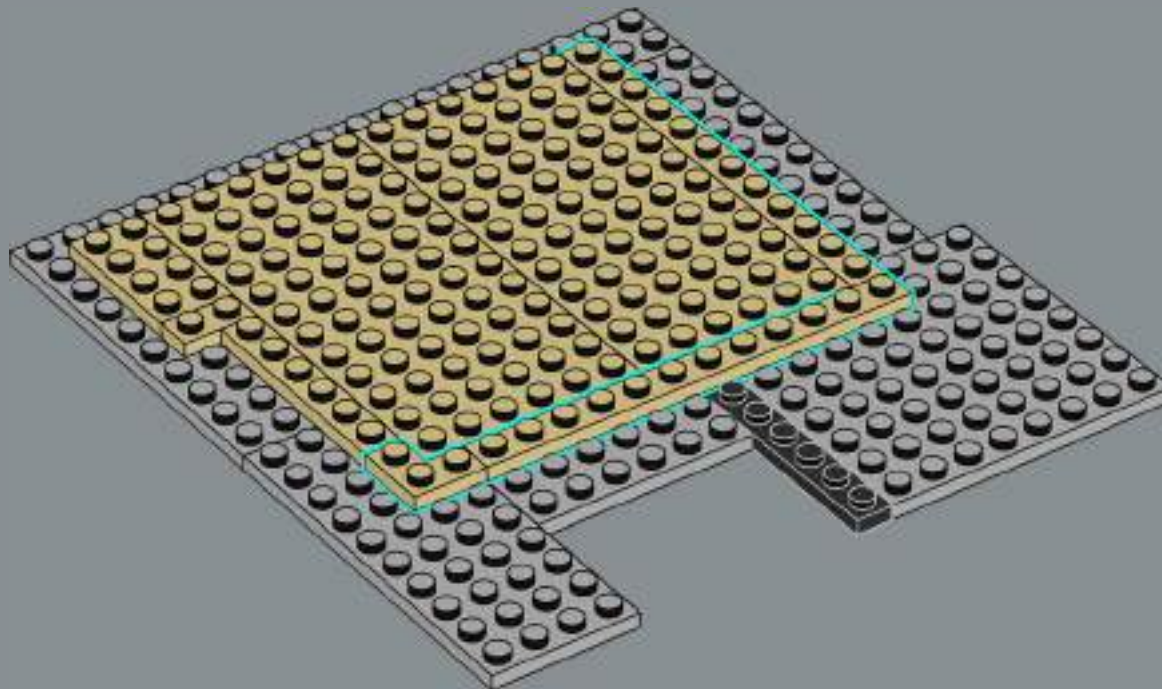

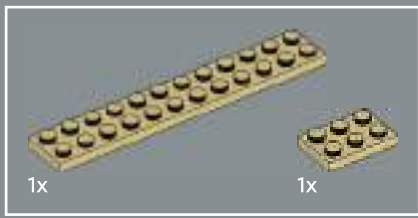

279

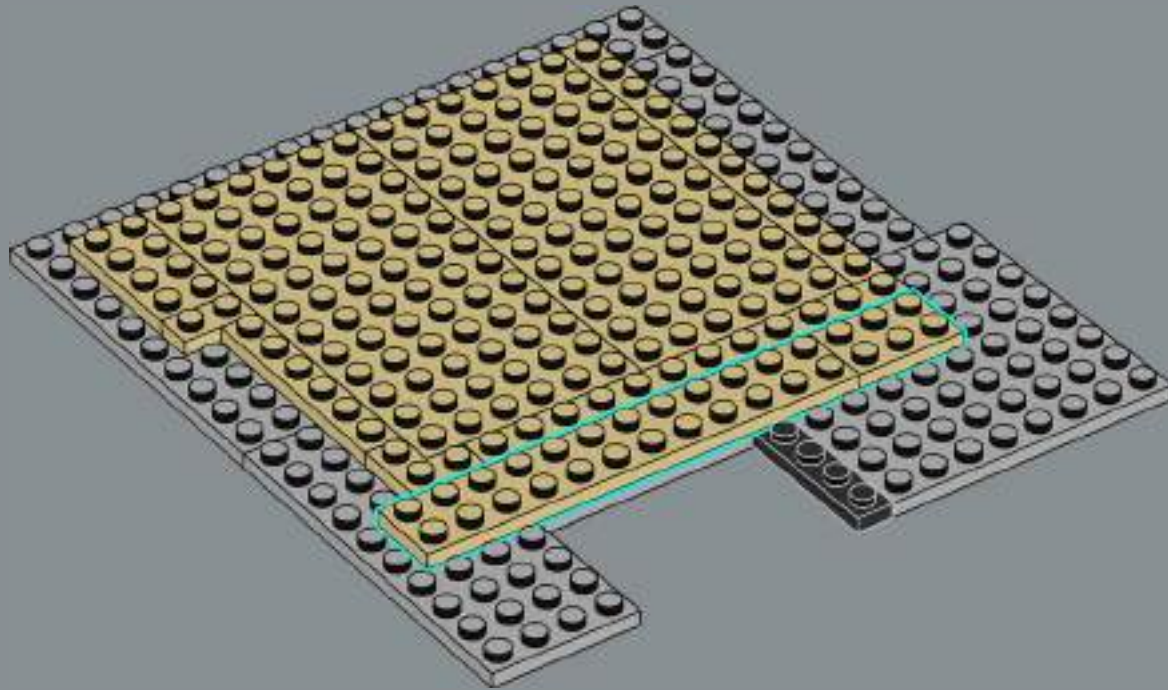



280

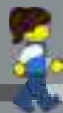
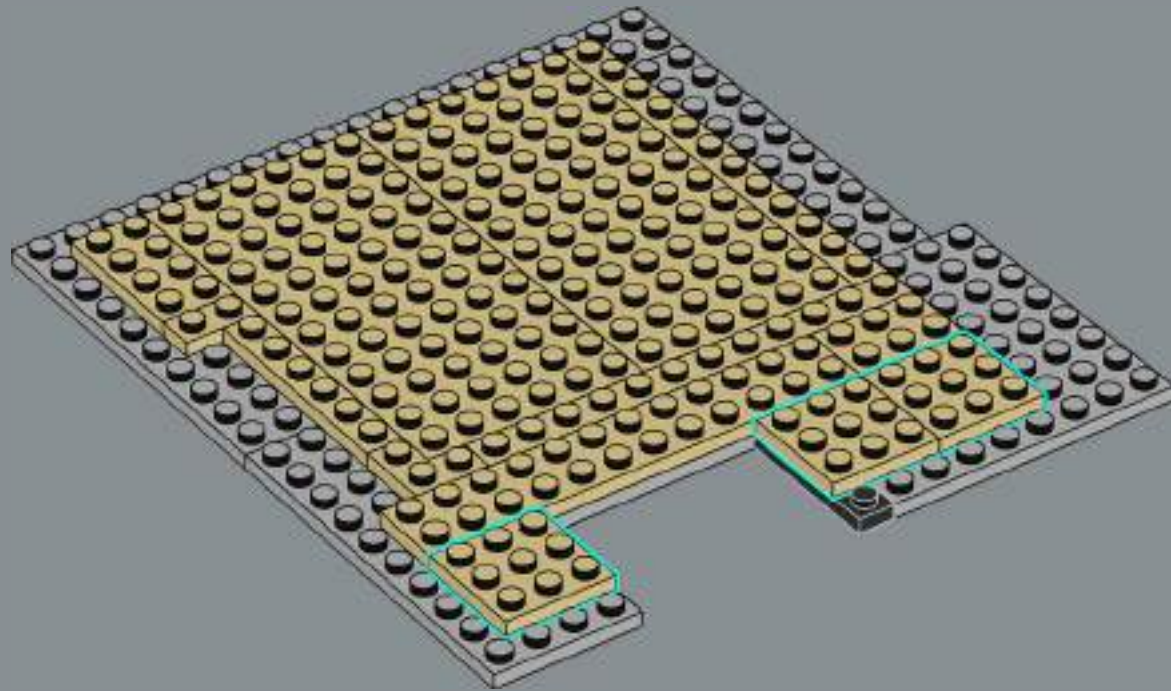

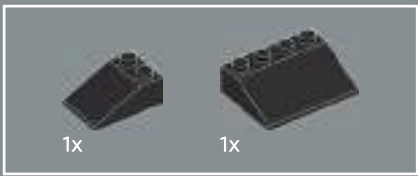

281

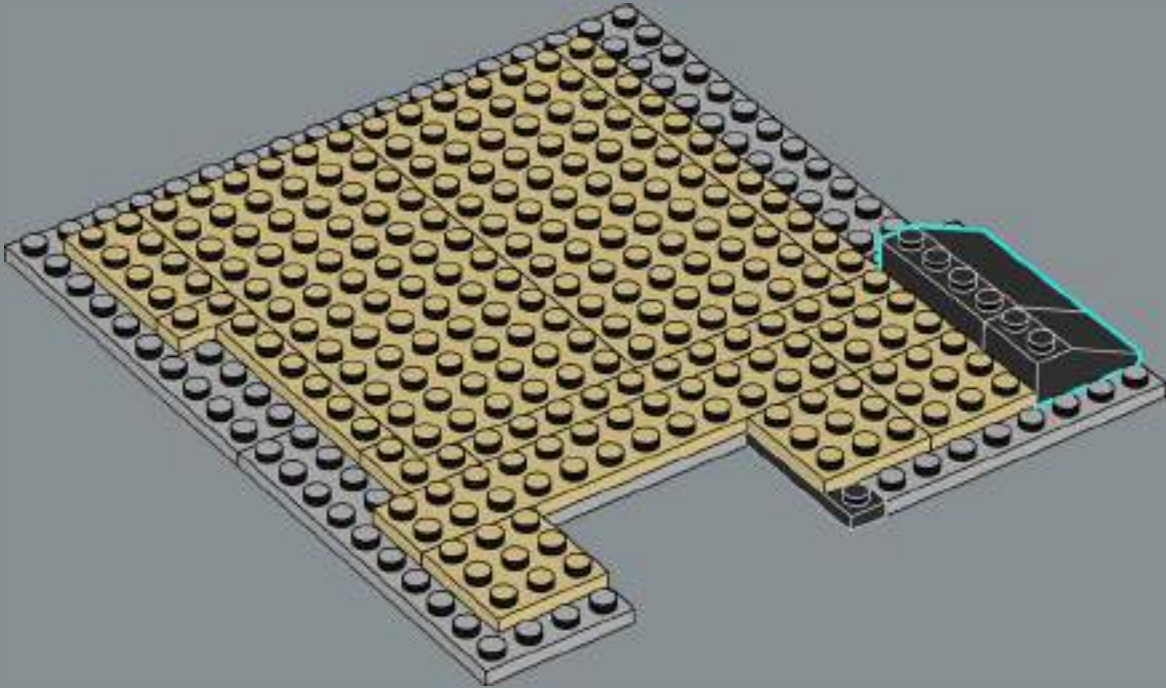

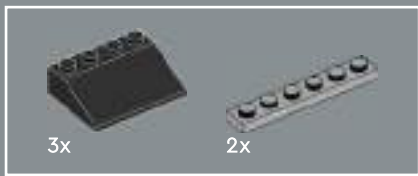

282

1

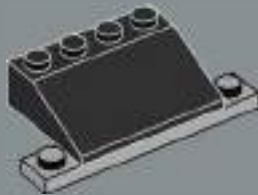

2

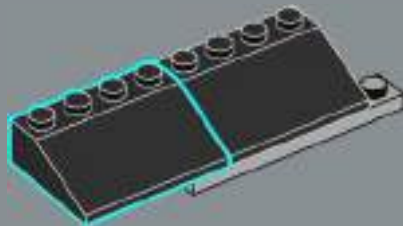

3

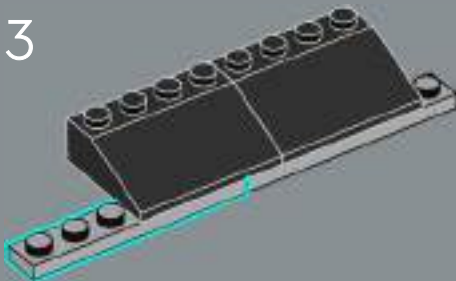

4

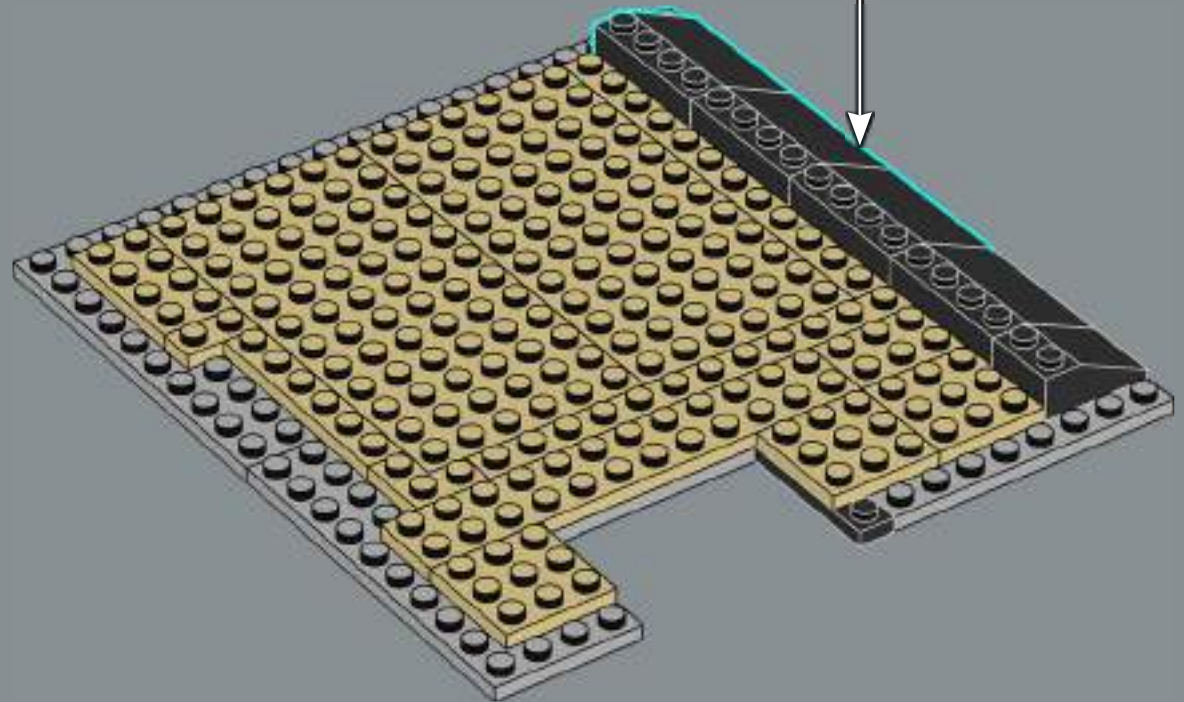
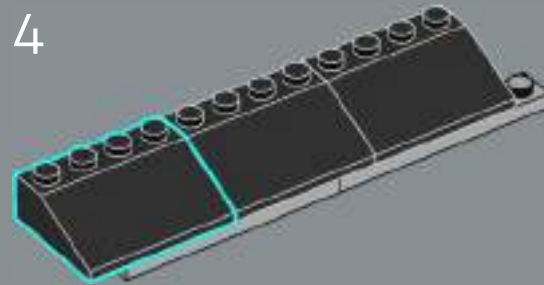

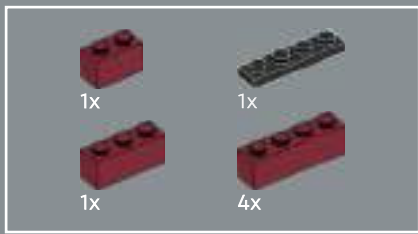

283

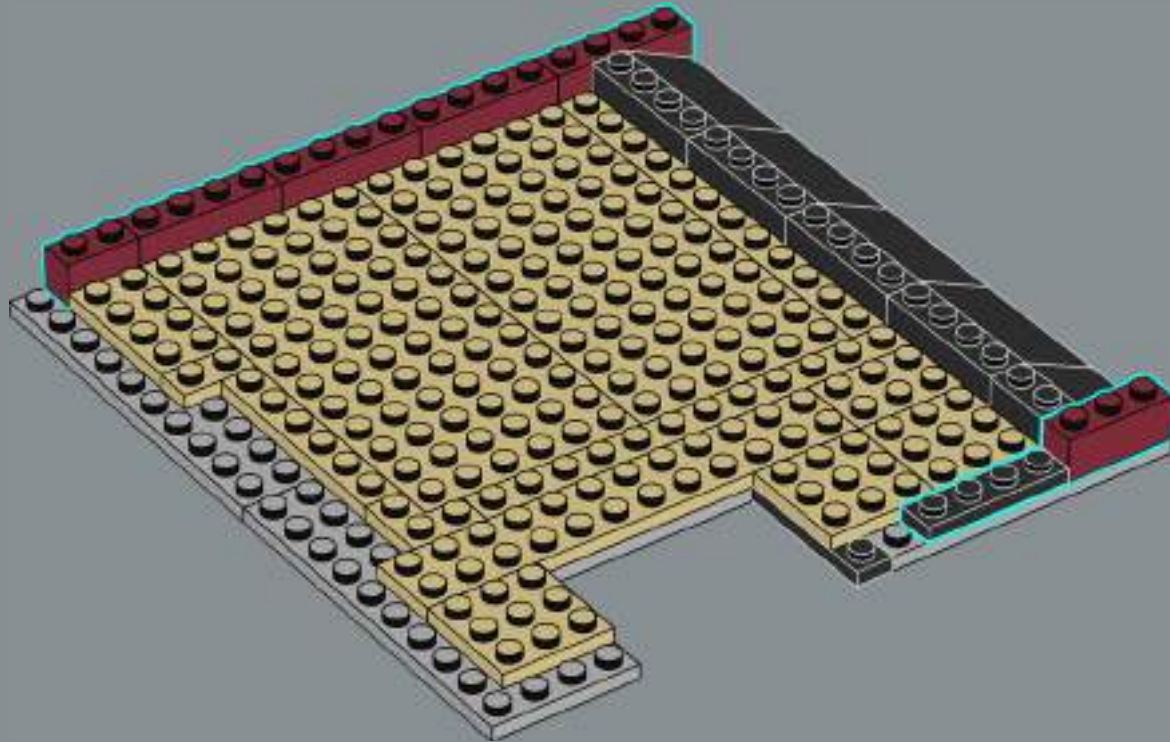



284

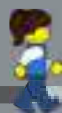
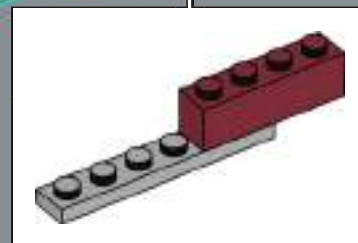
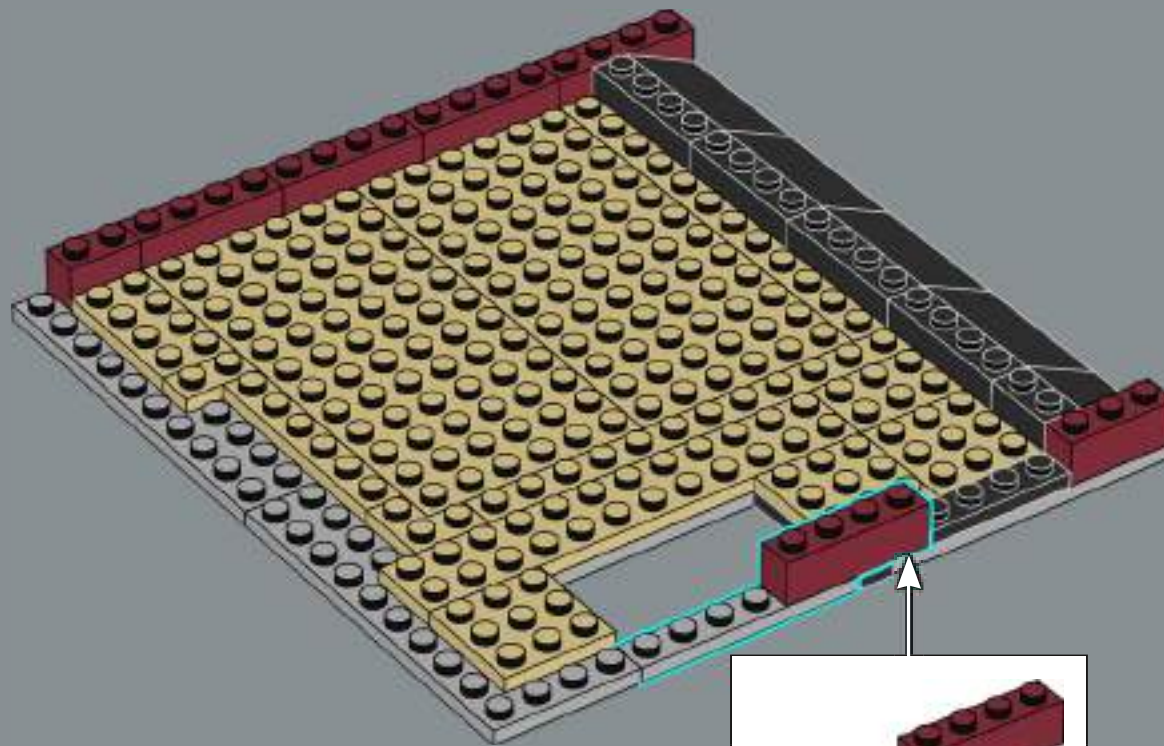

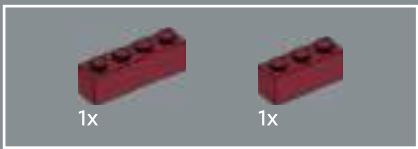

285

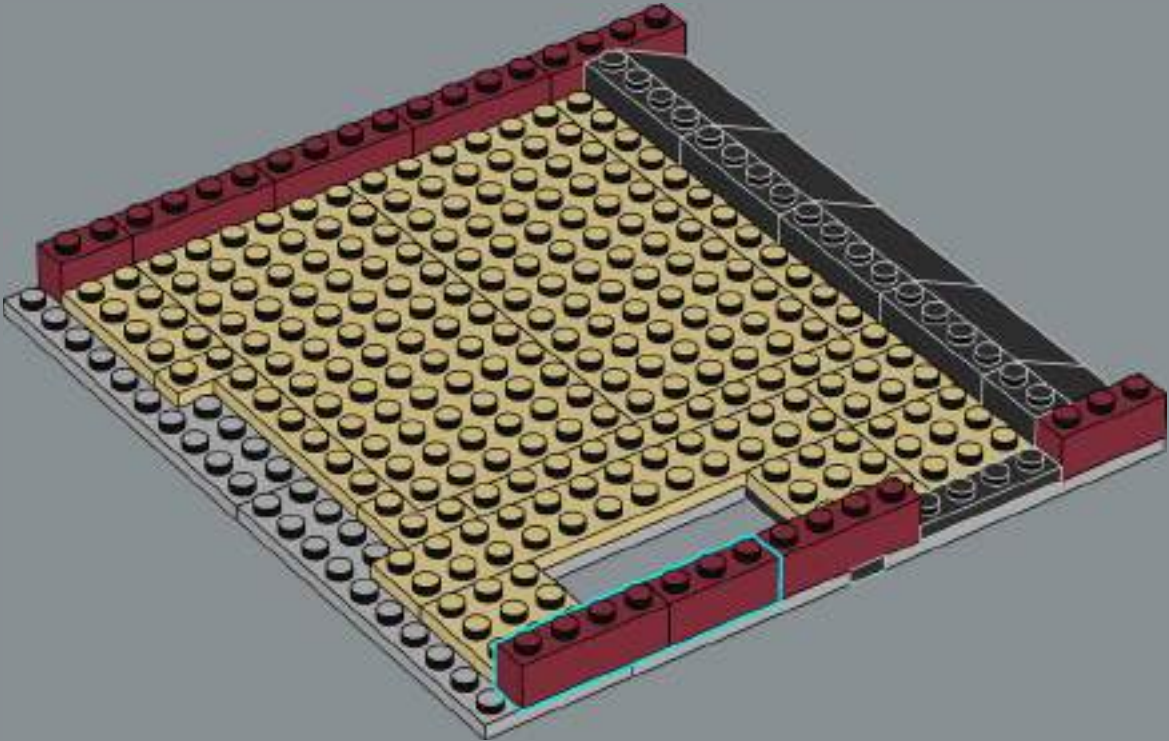

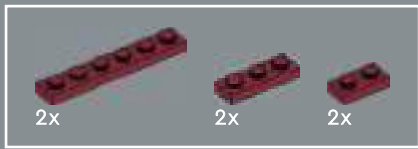

286

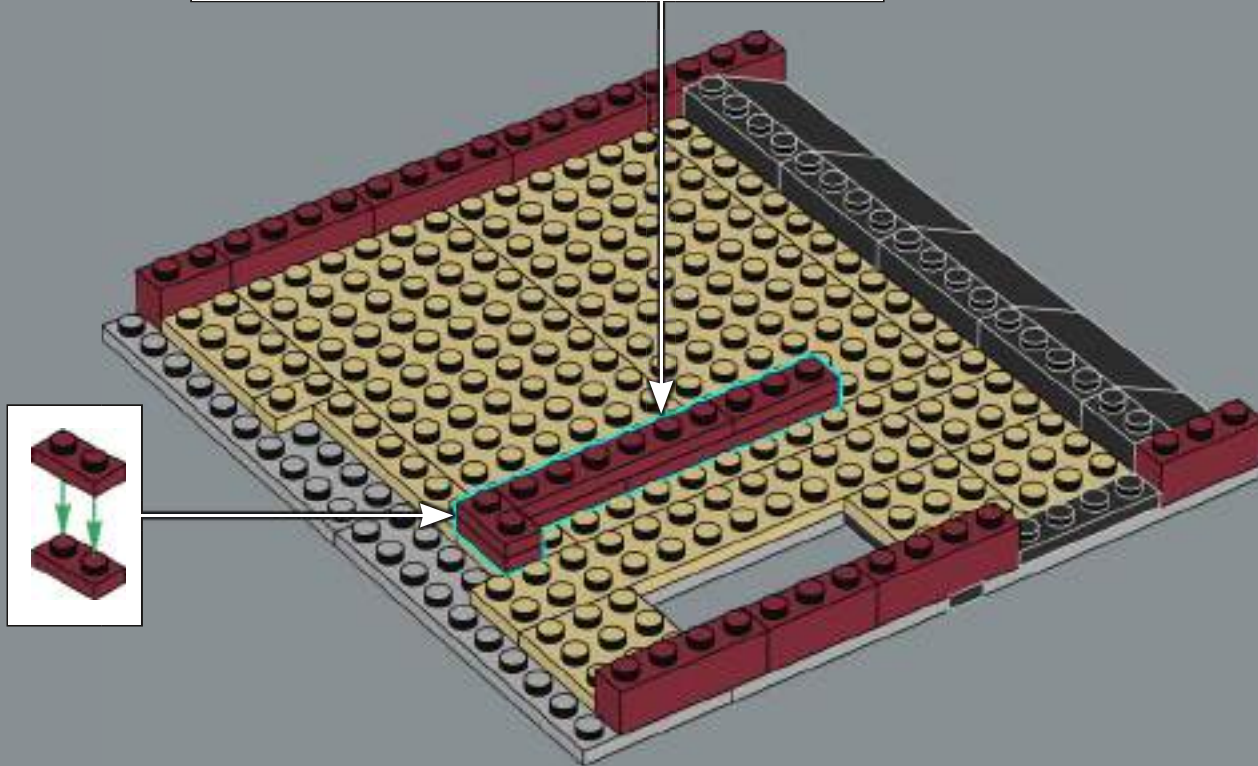
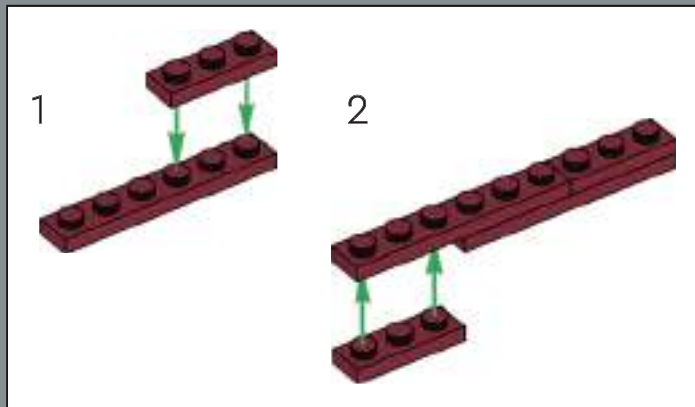

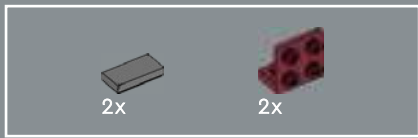

288

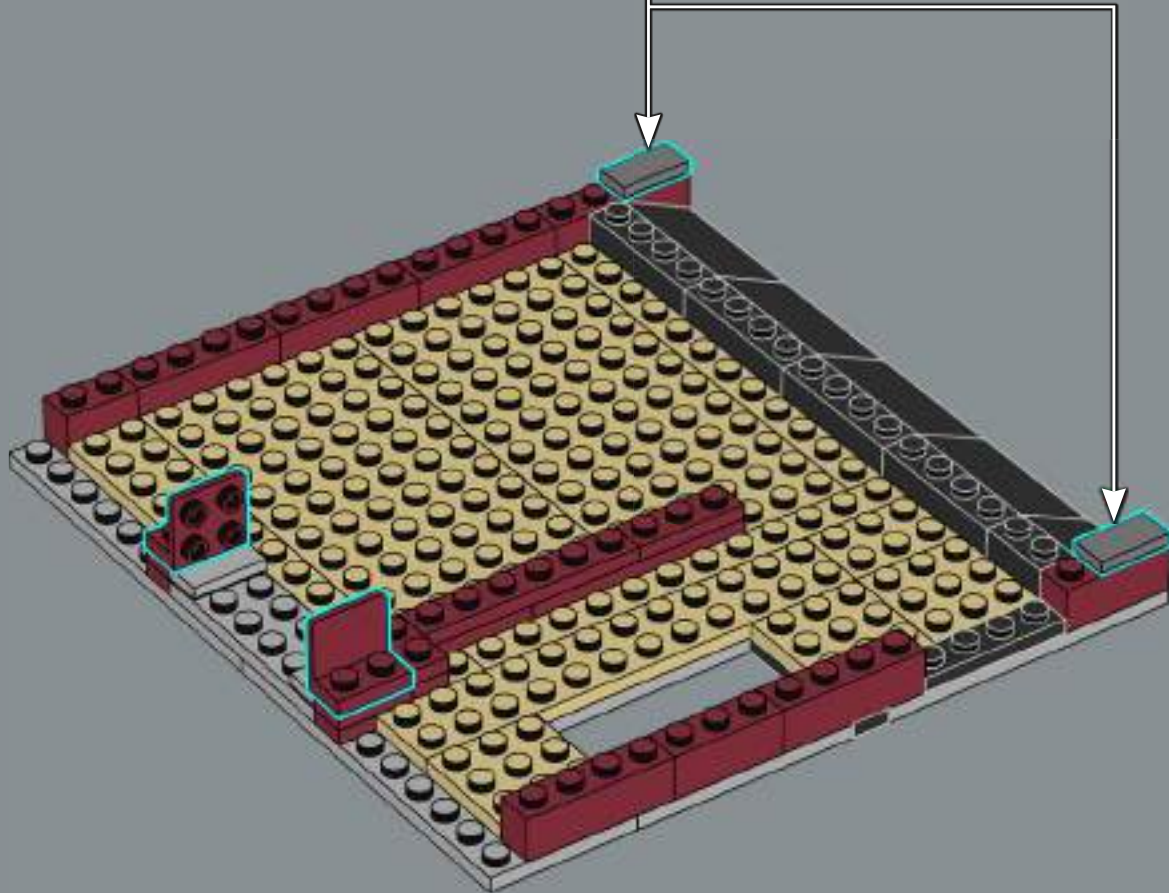

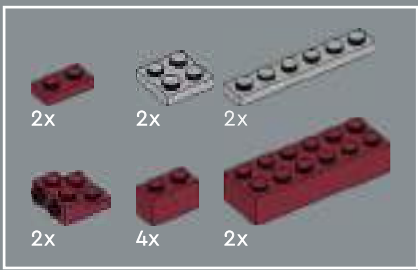

289

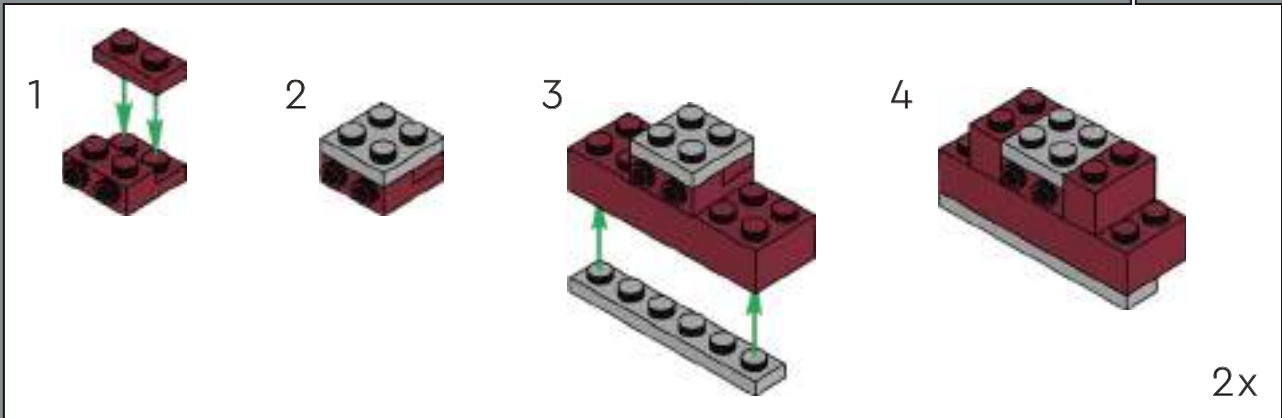
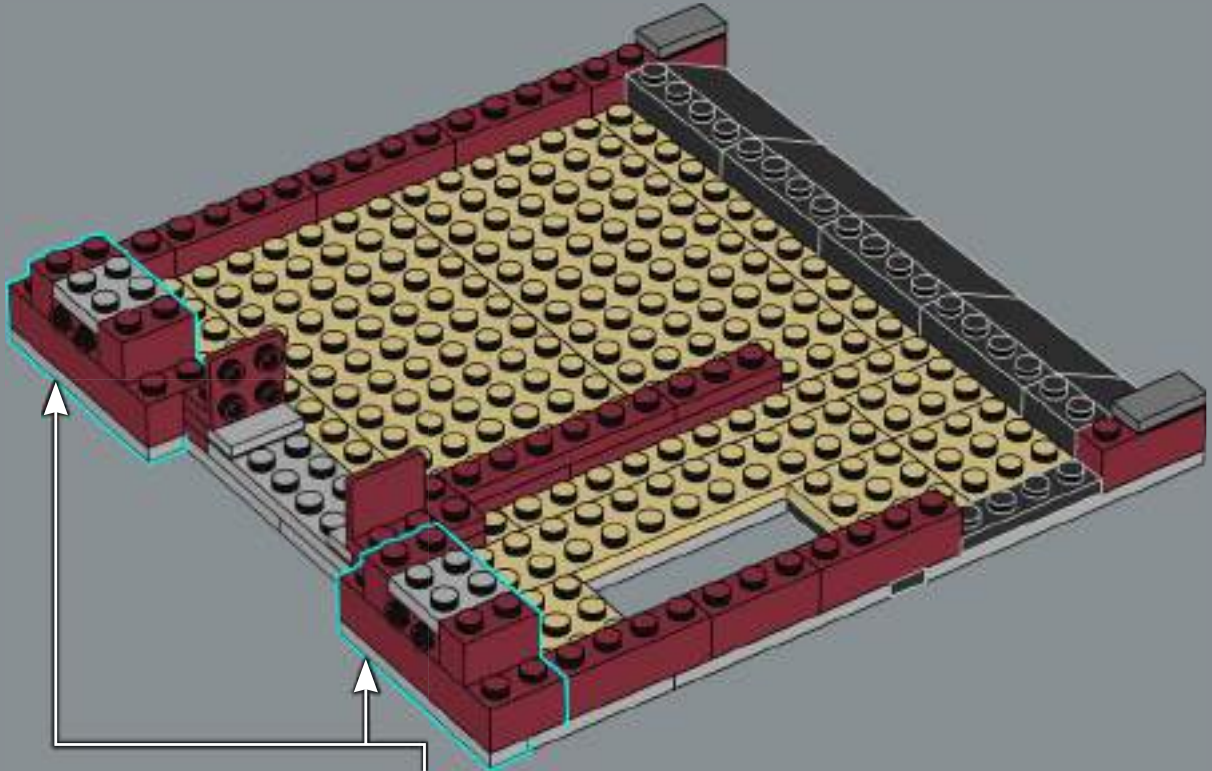



290

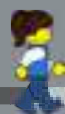
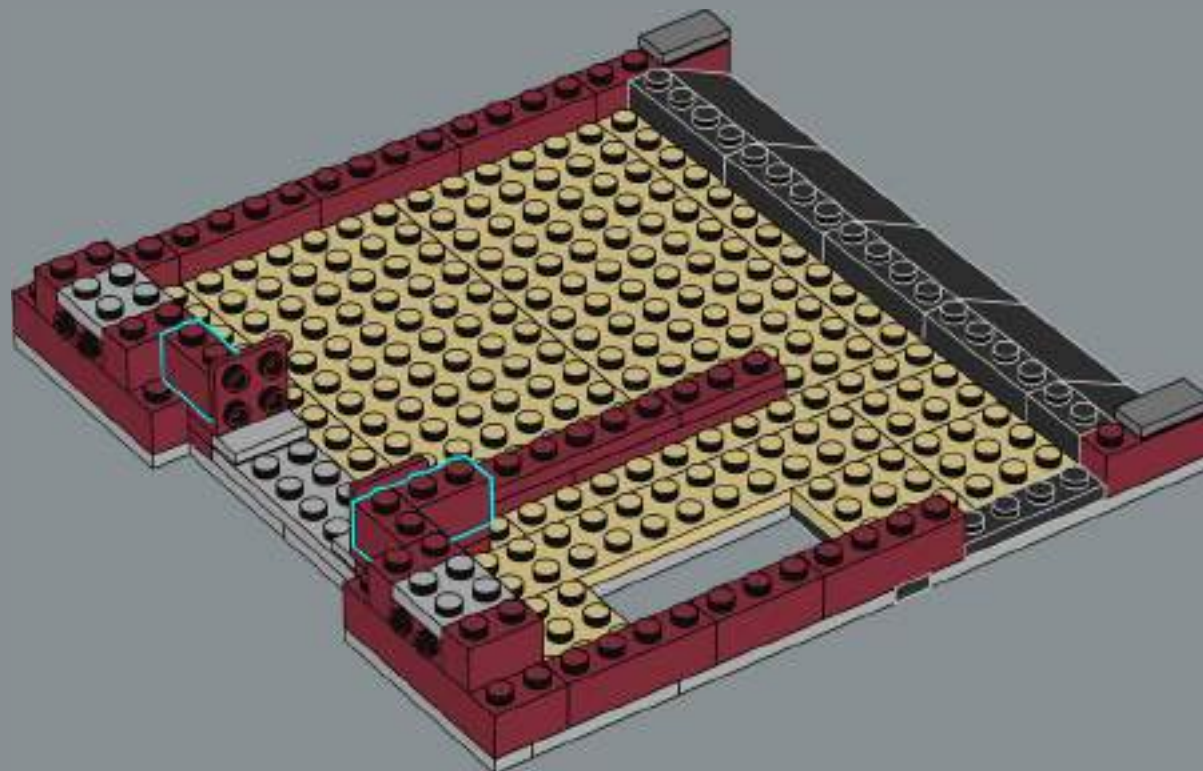



291

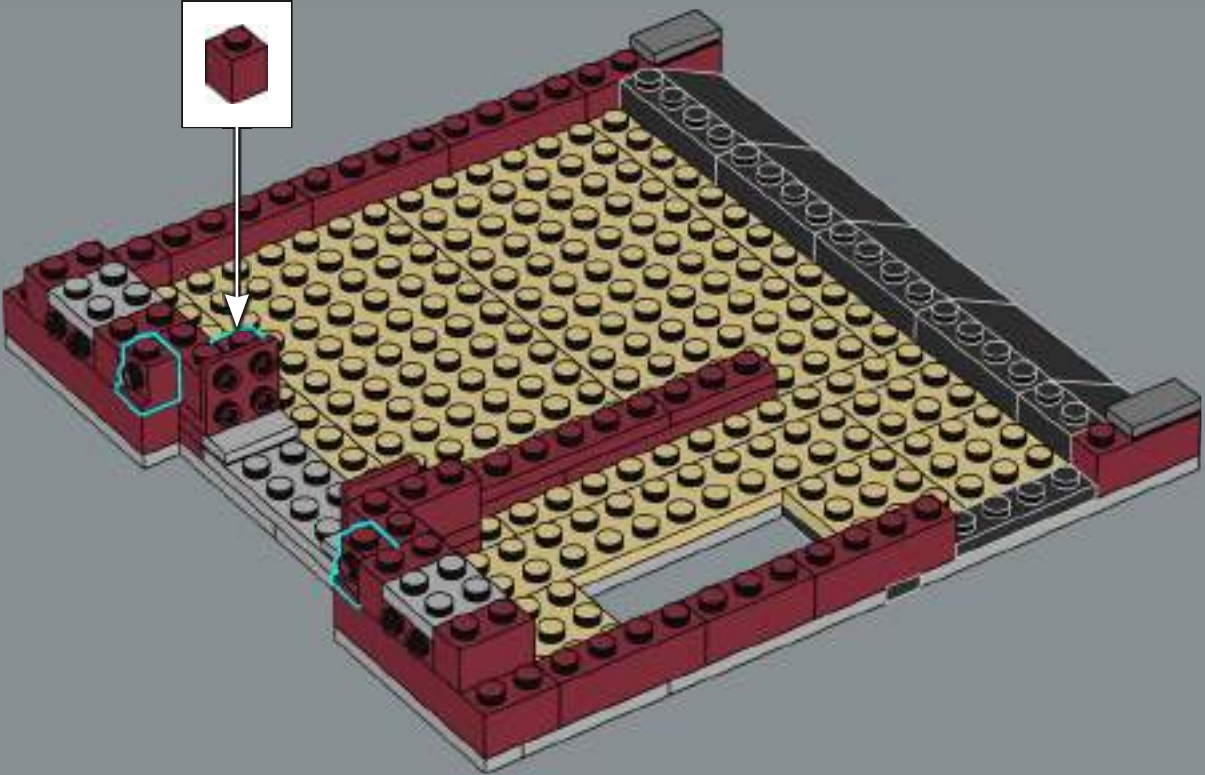



292

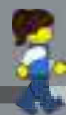
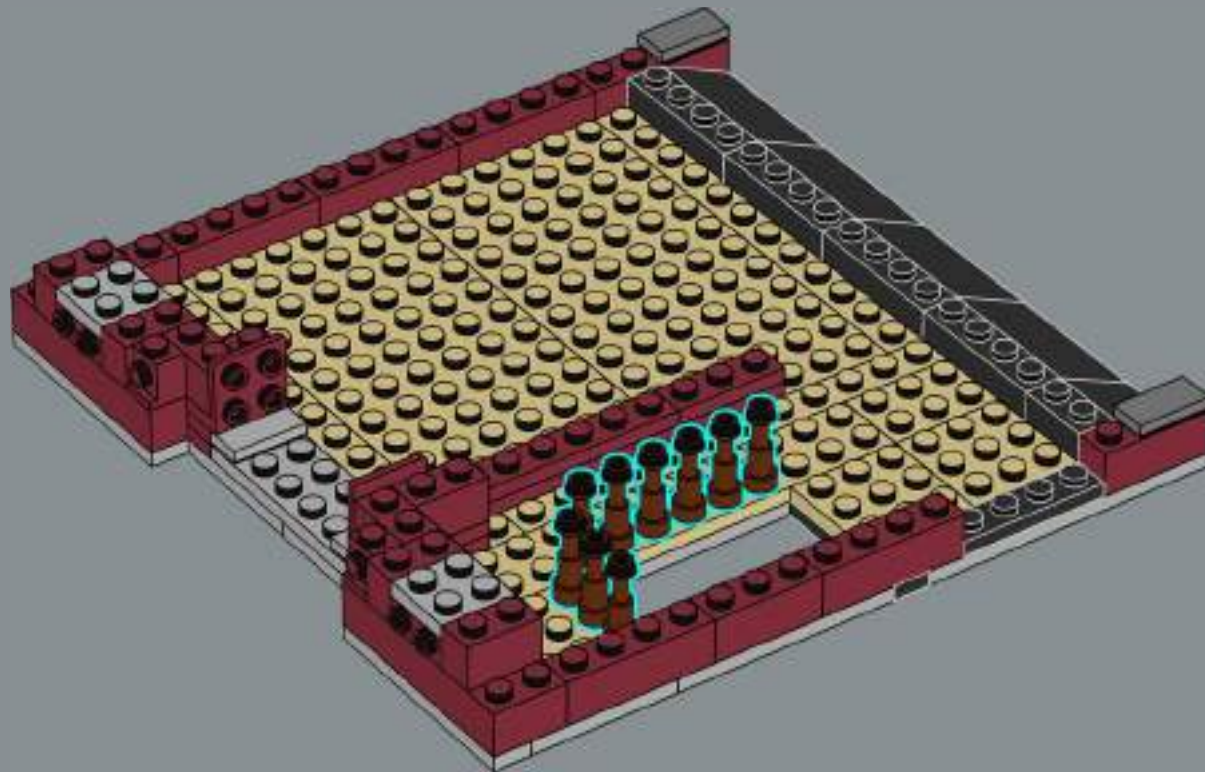



293

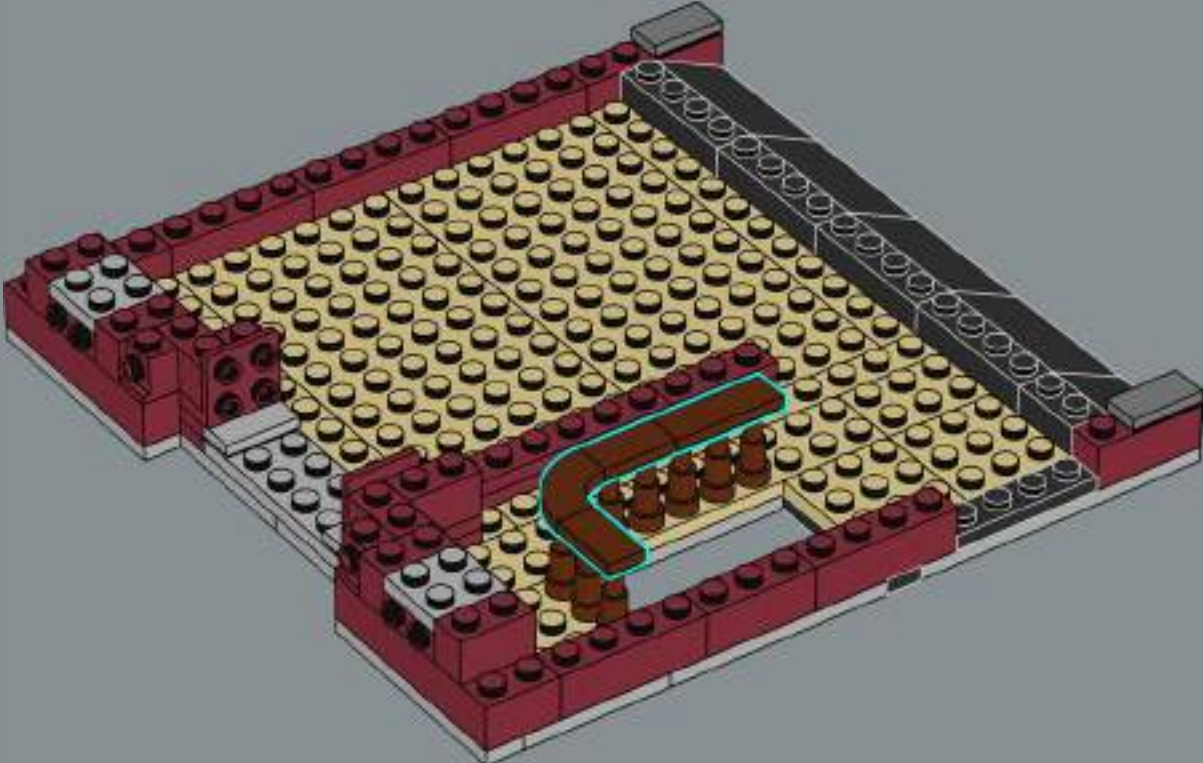



294

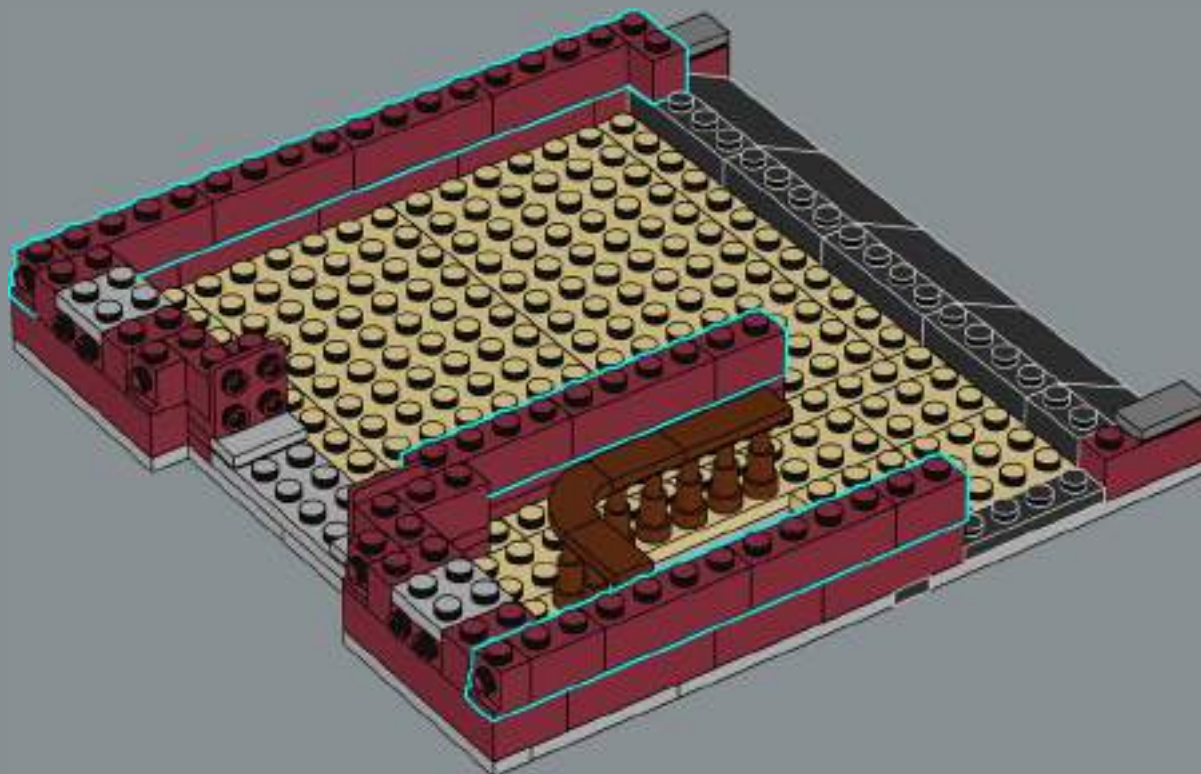



The element used to make the windowsills (1x2 plate with handles) has been in the LEGO® System since 1978!

295

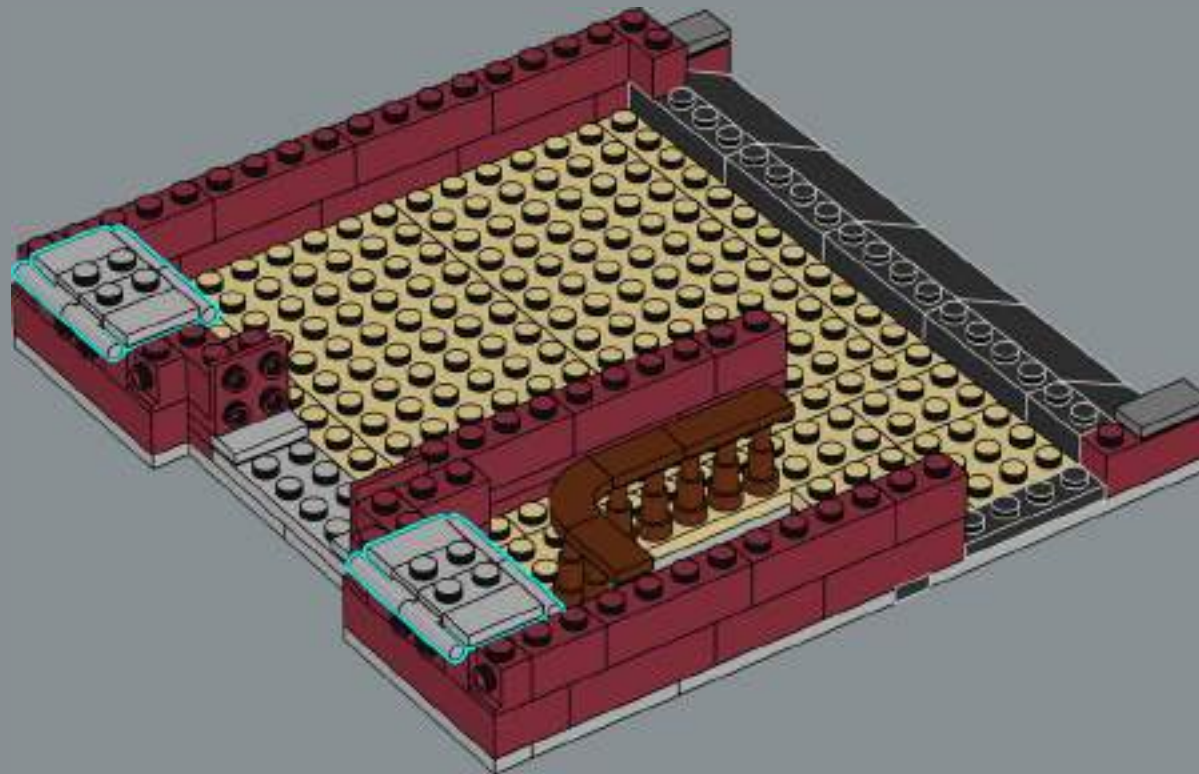



296

1



2



3

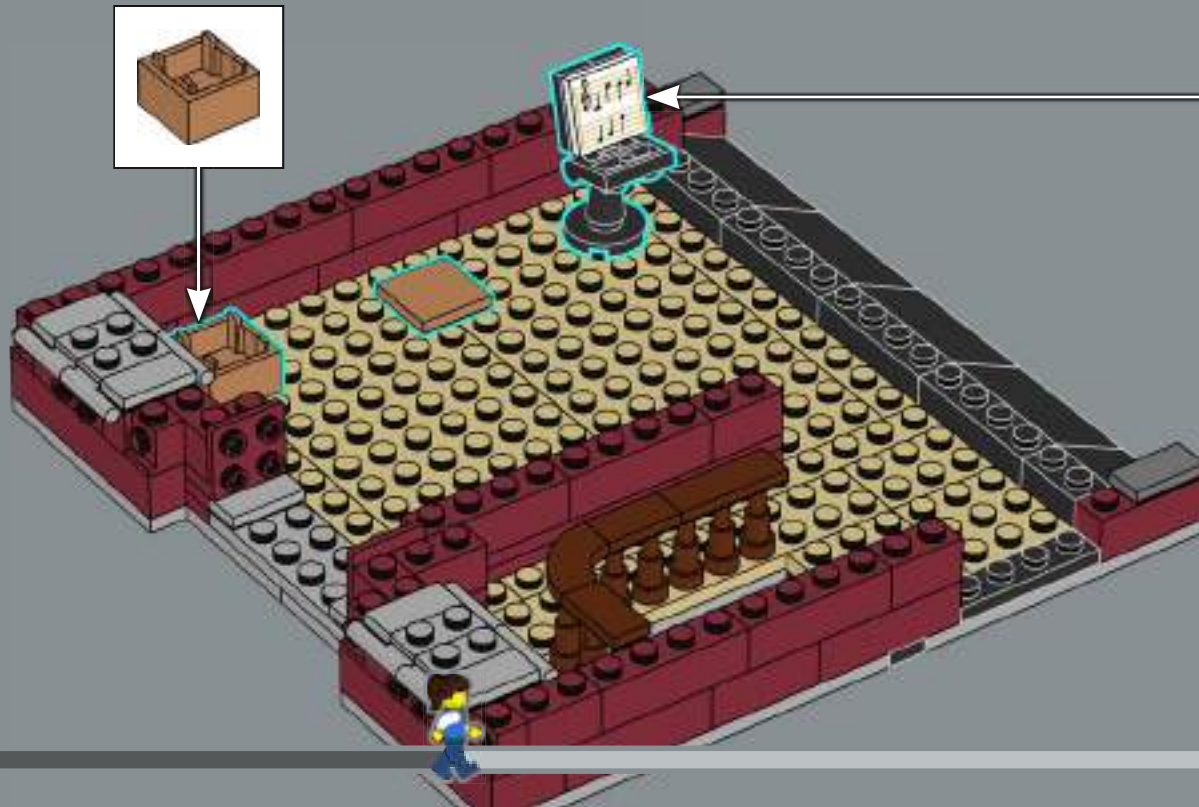

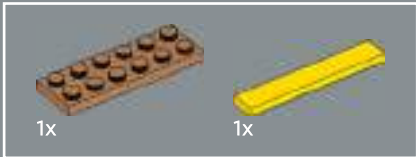

297

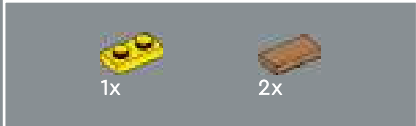
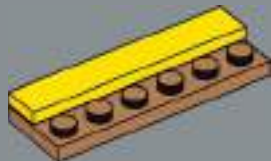

298

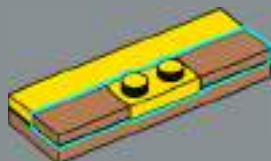

299

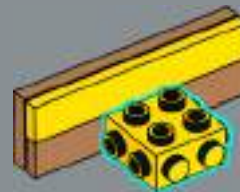

300

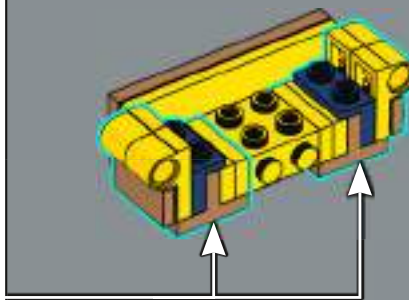
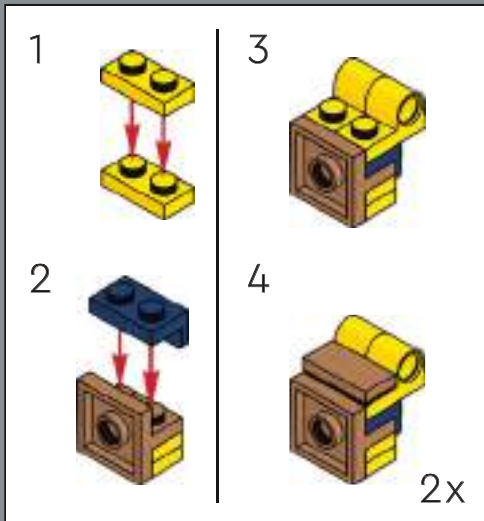

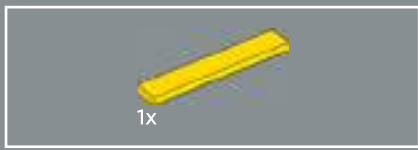

301

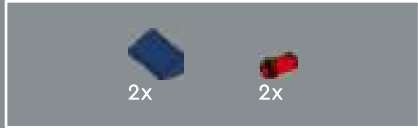
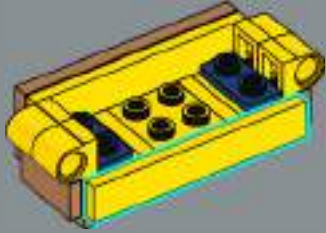

302



303



304

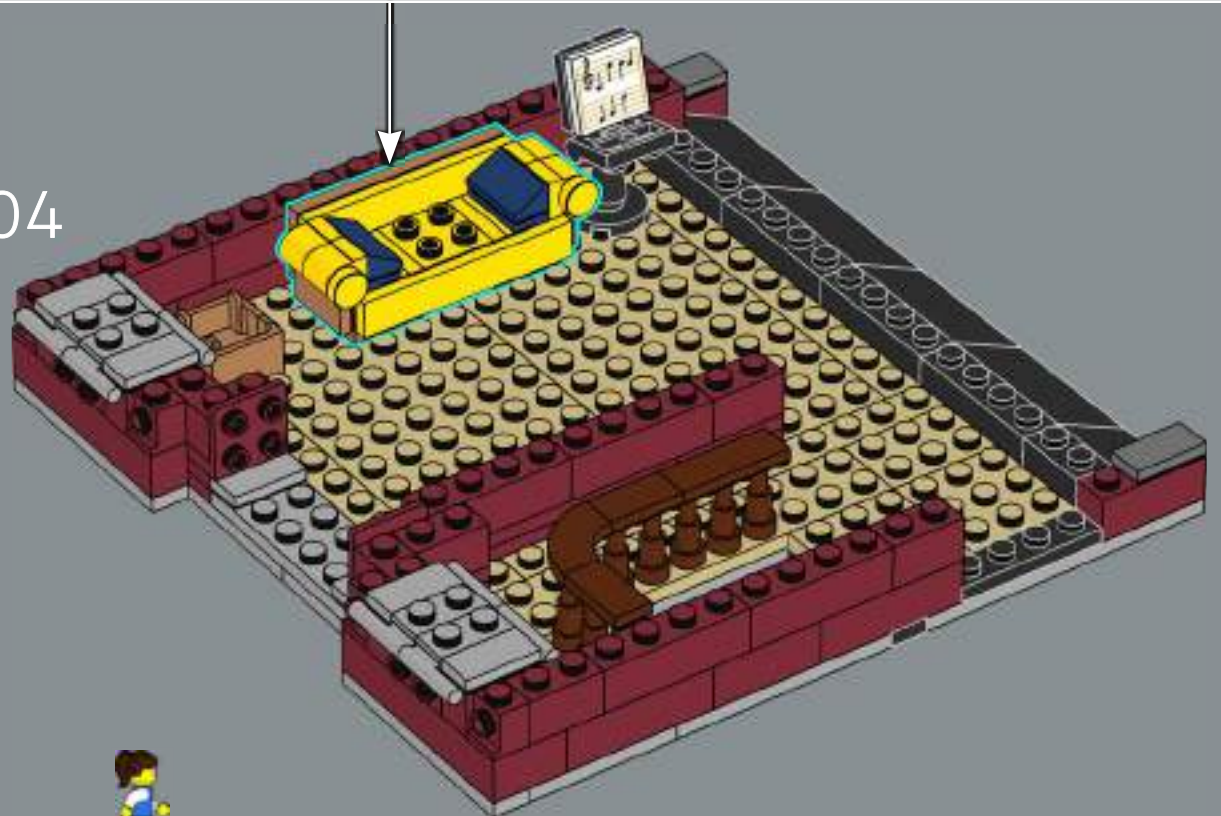



305



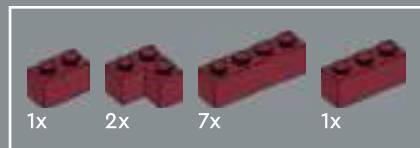

306

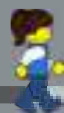
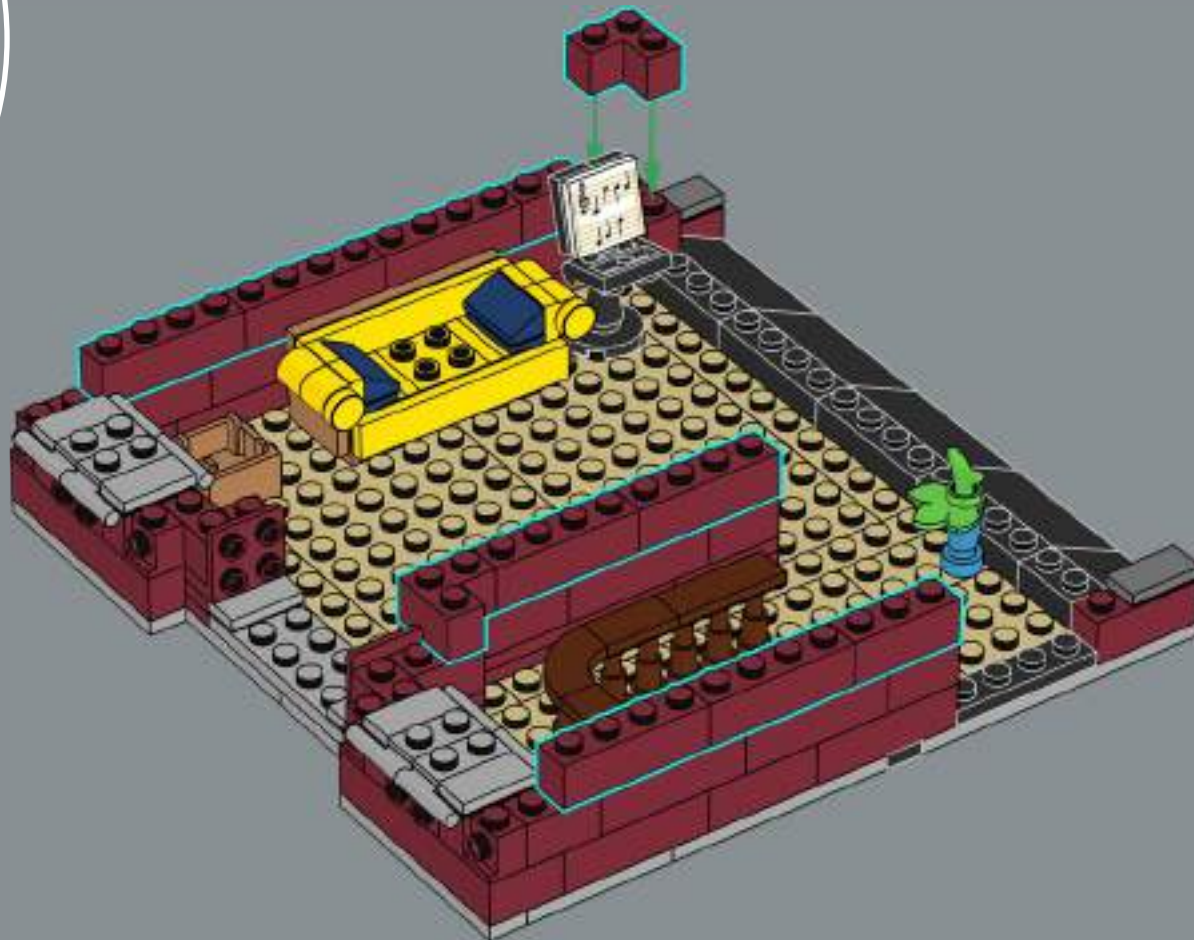



307

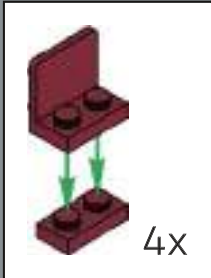



308

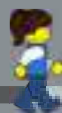
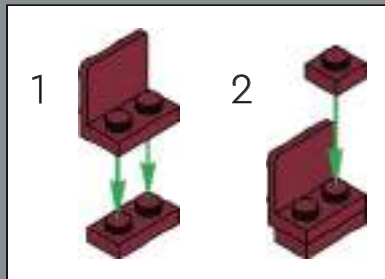
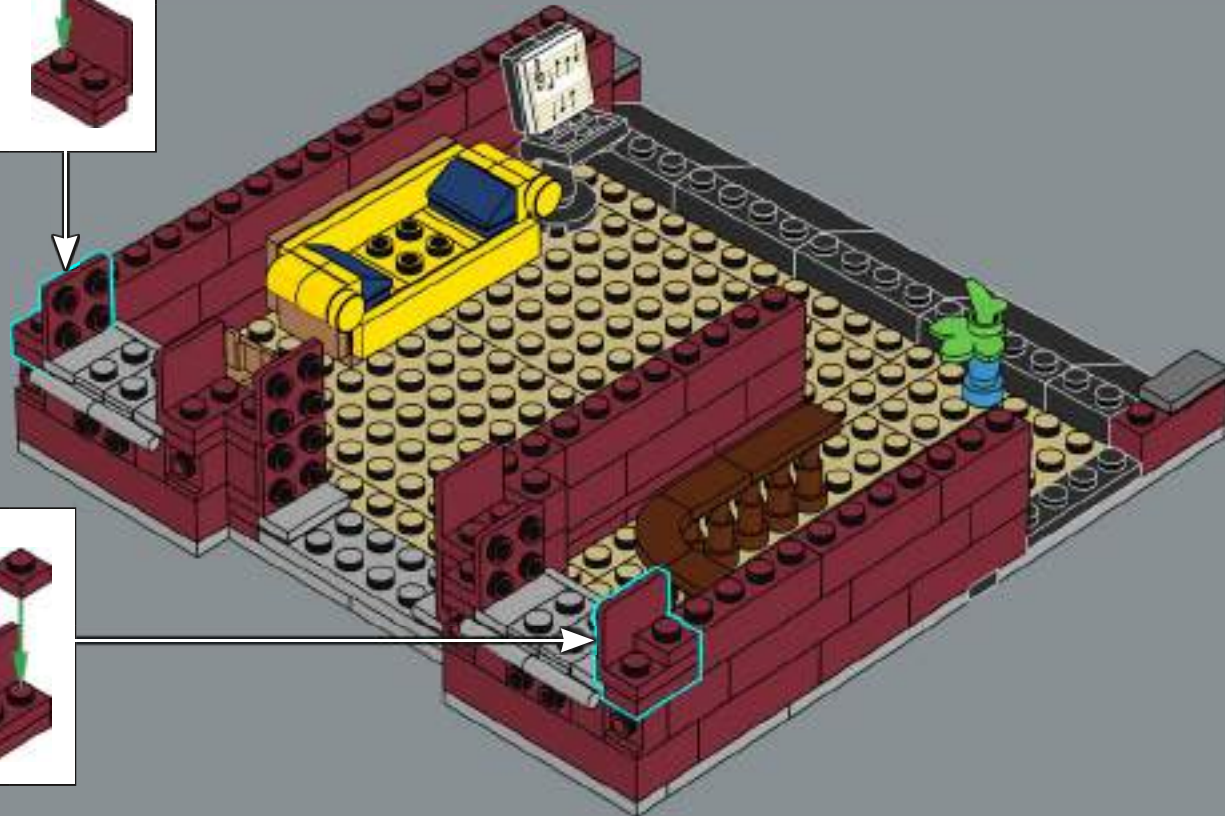
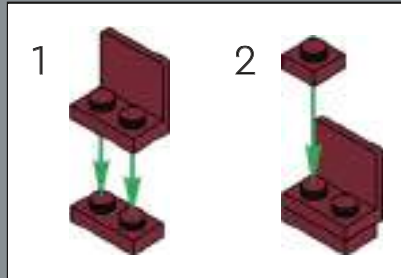



309

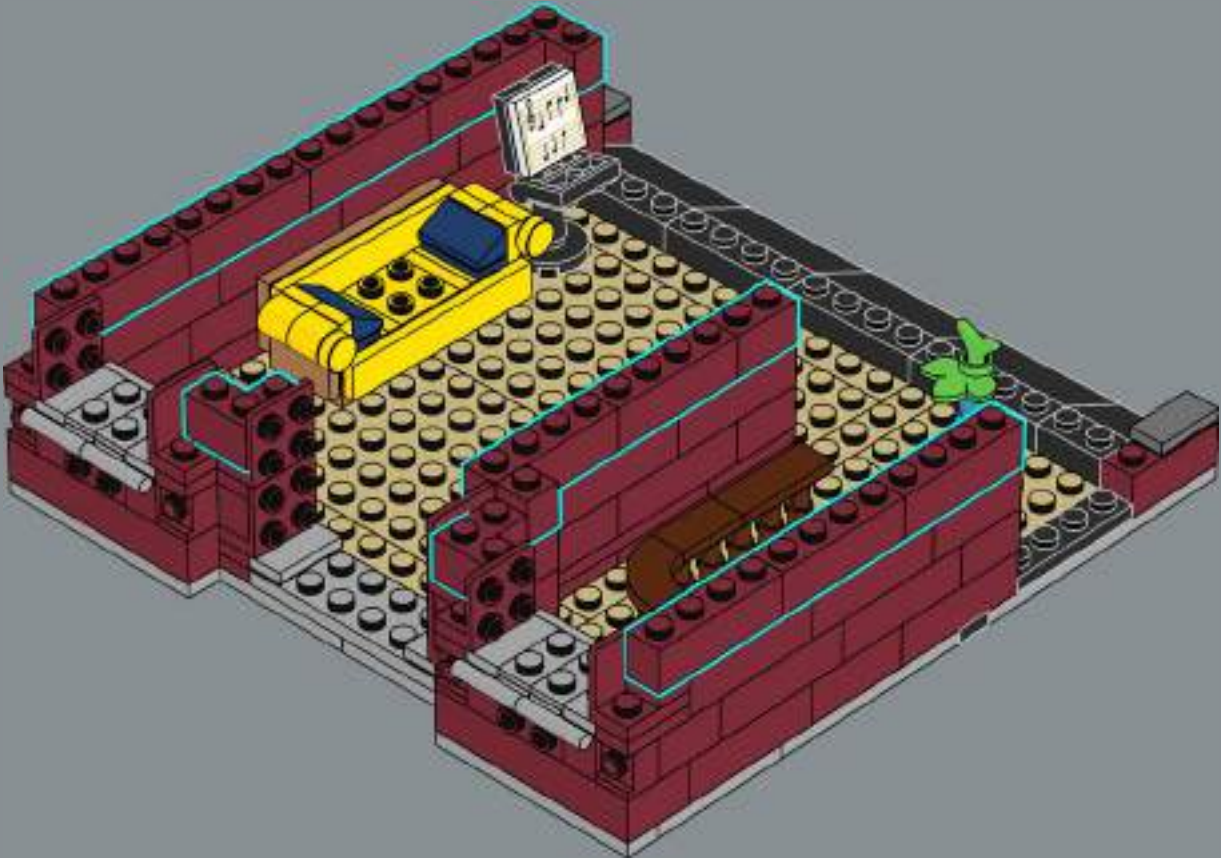



4x

310

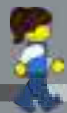
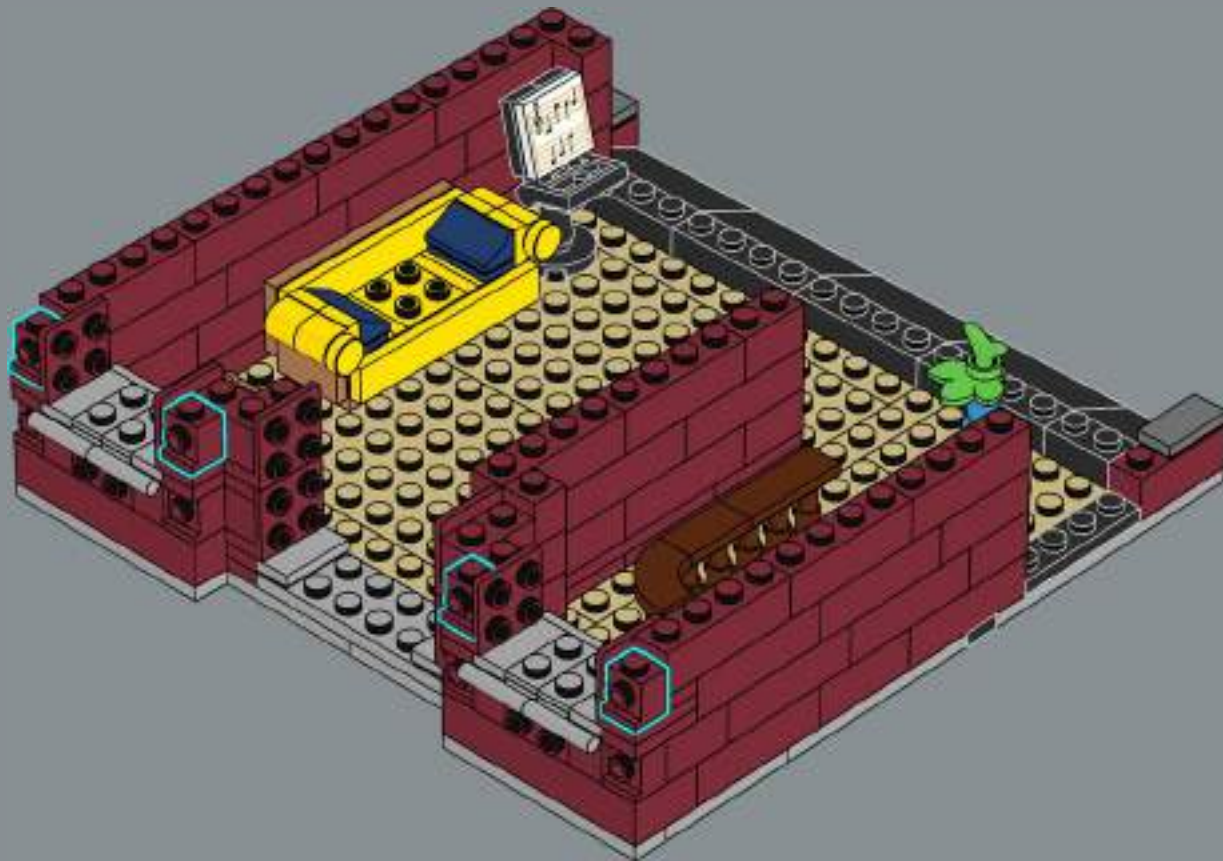



311

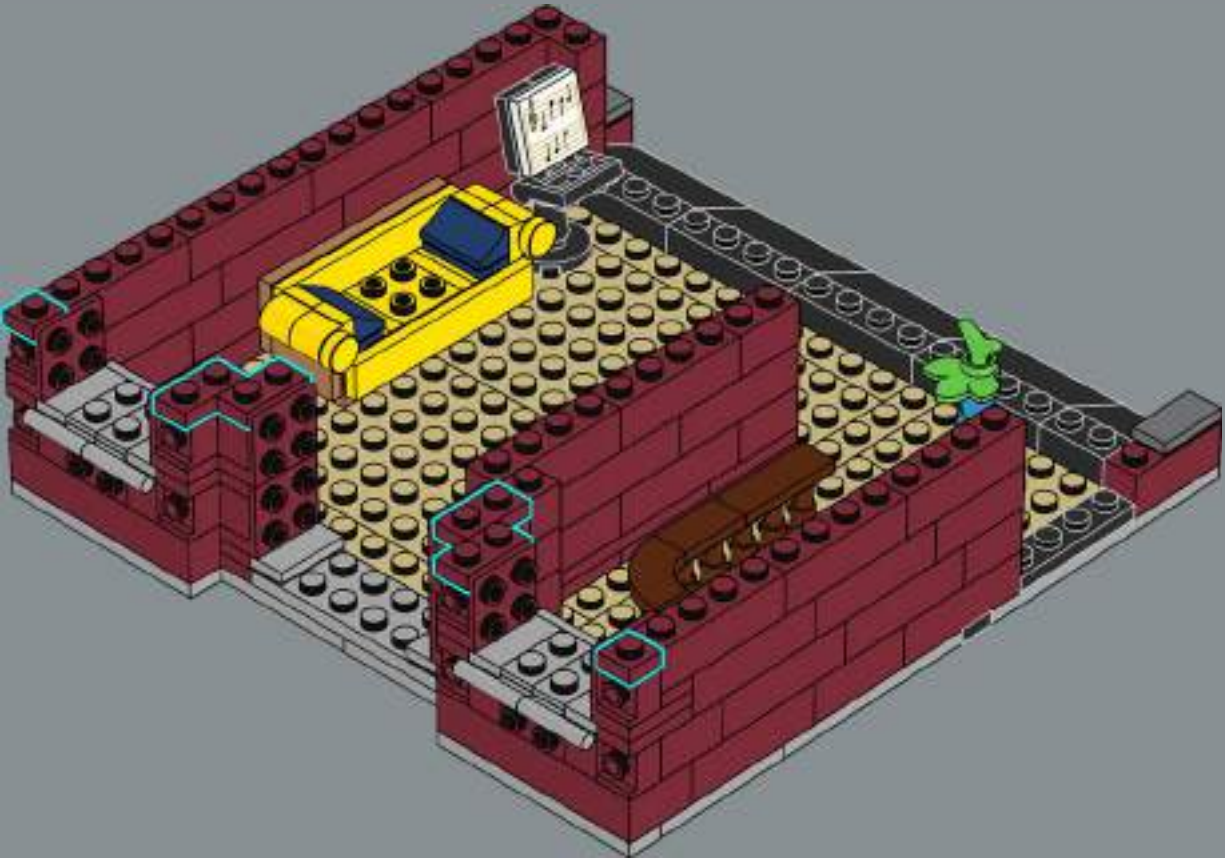

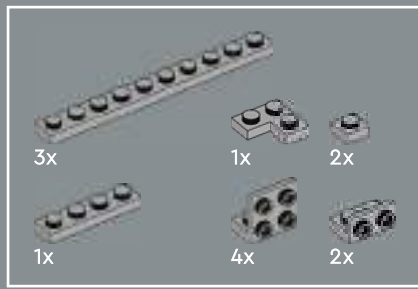

312

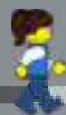
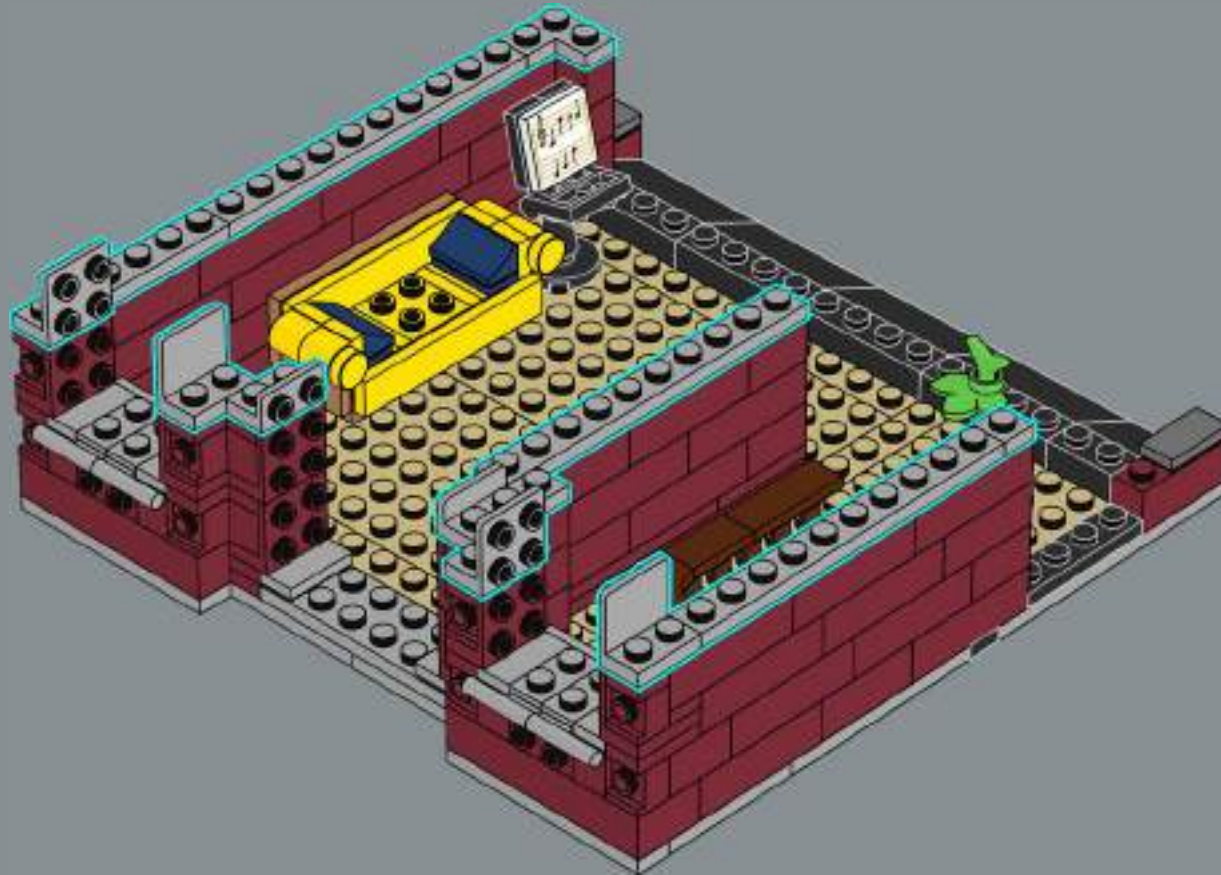

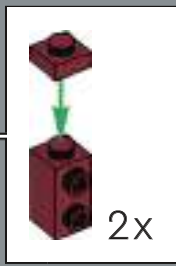
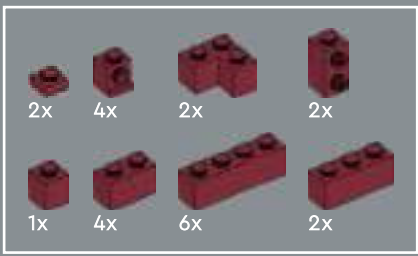

313

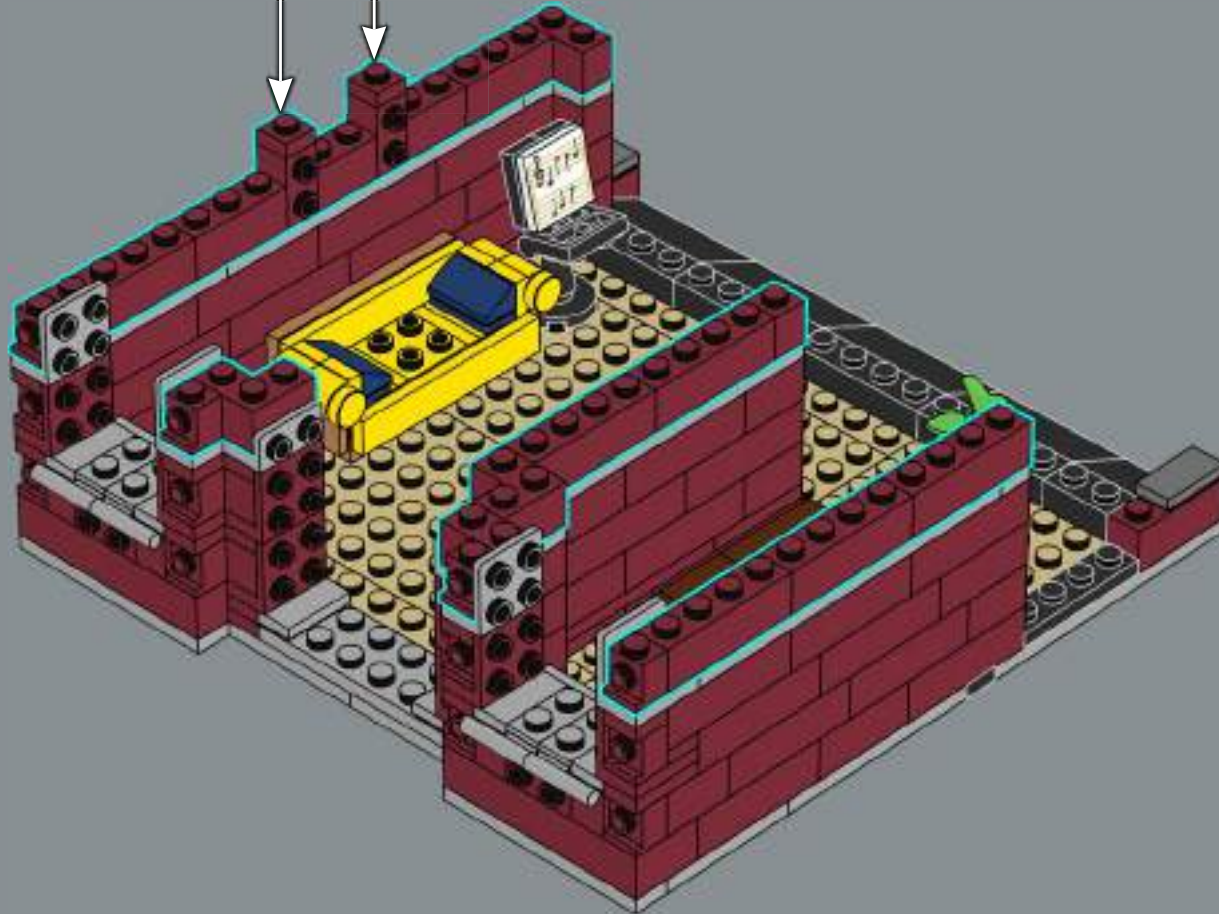



314

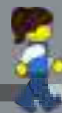
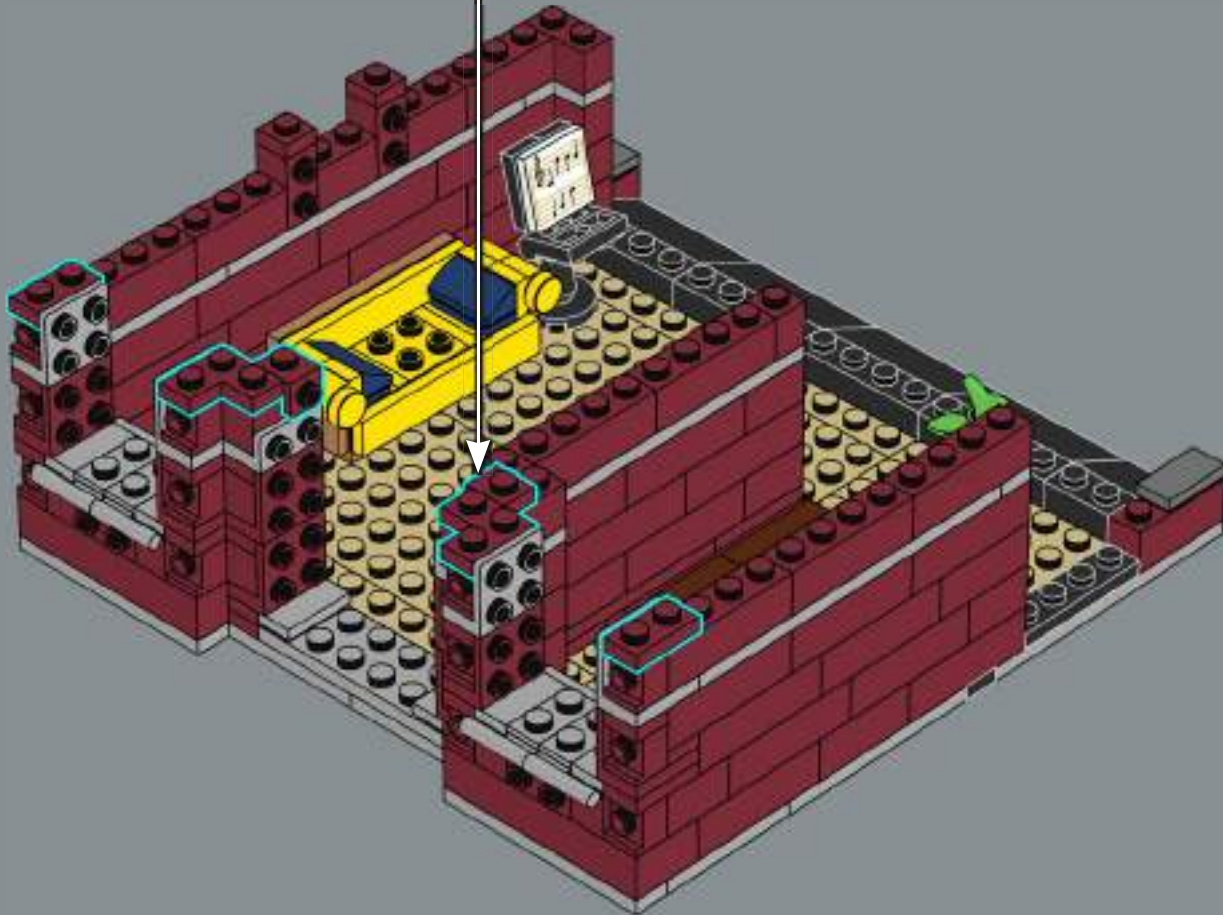



8x

315

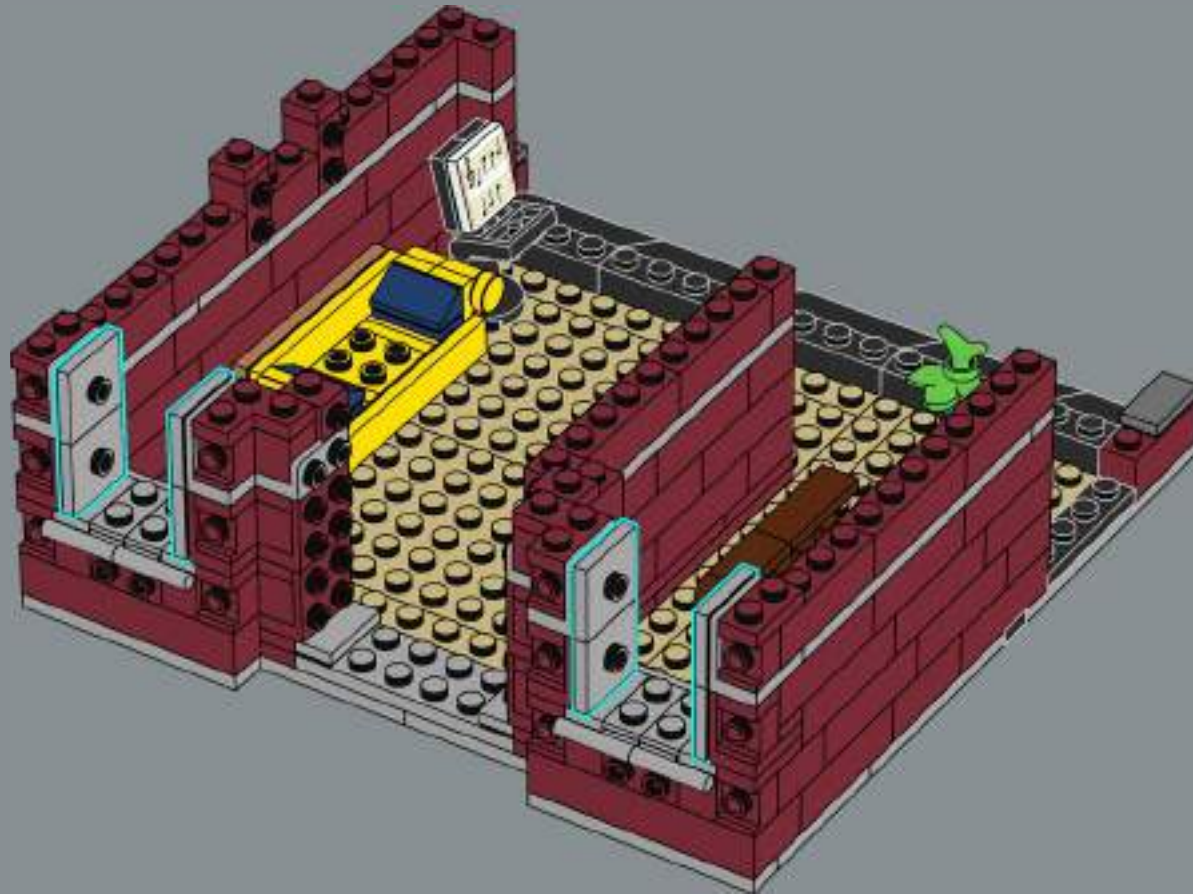



316

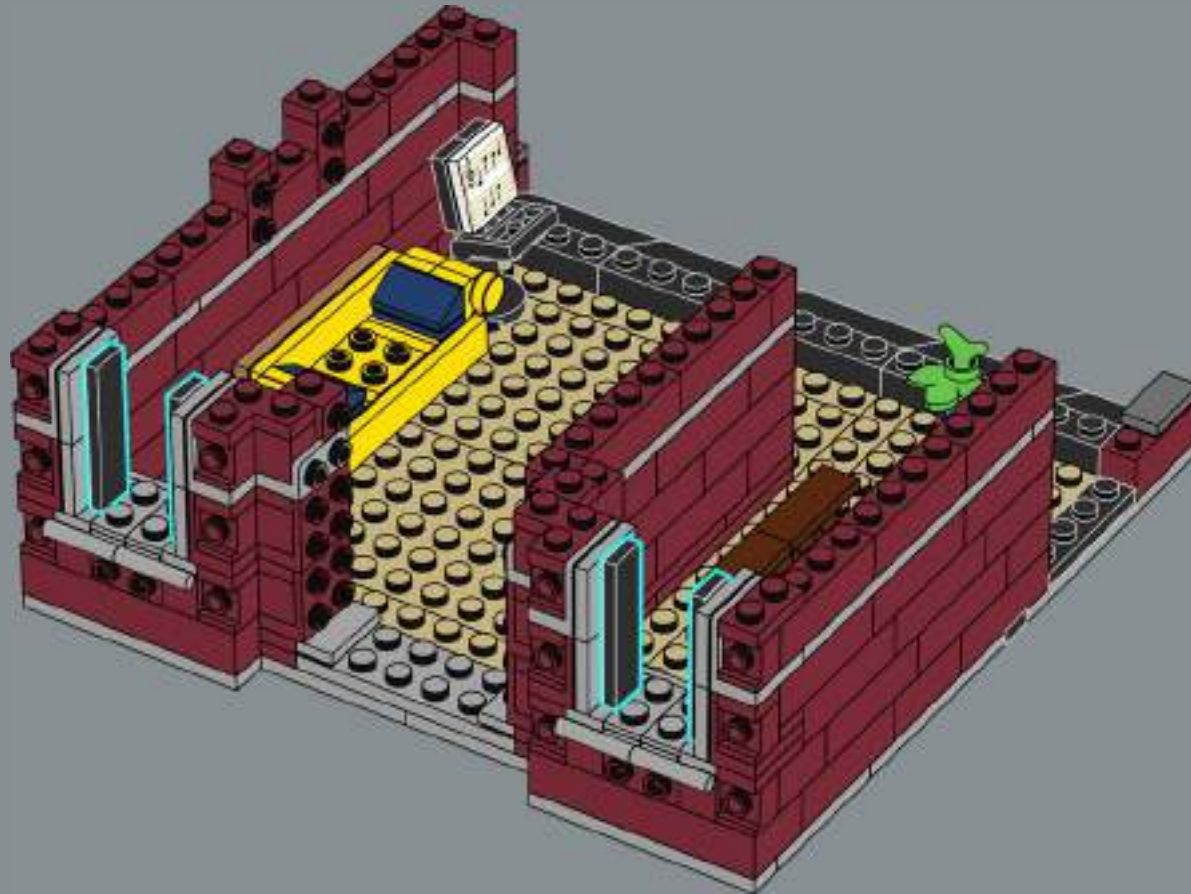



317

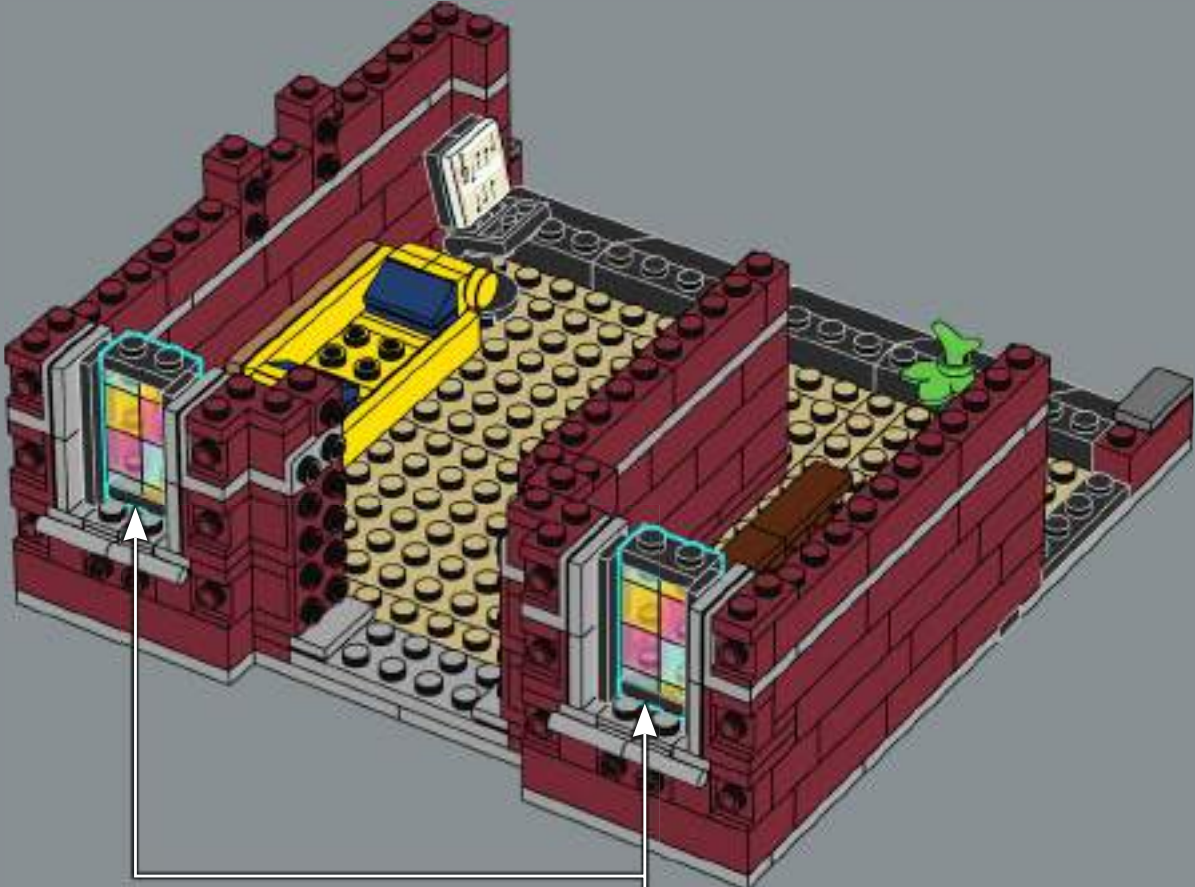



318

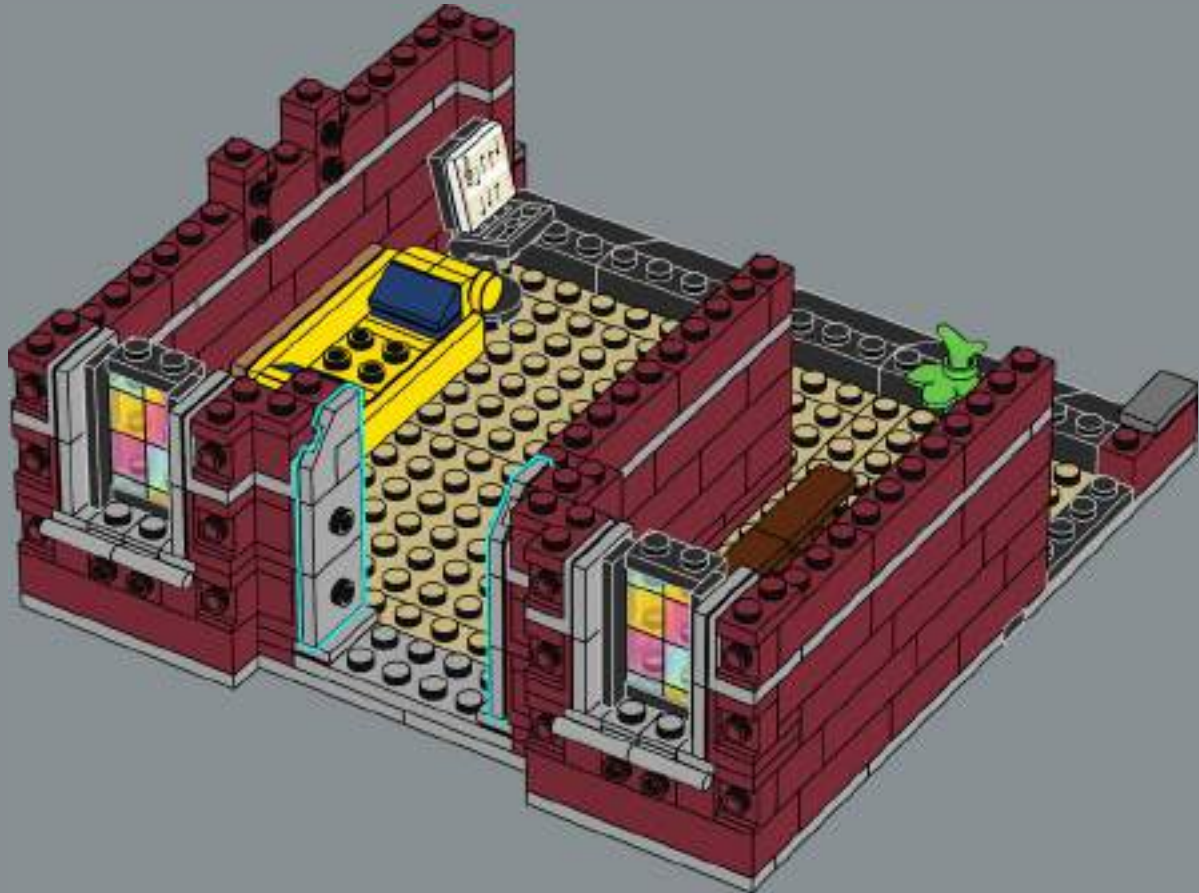

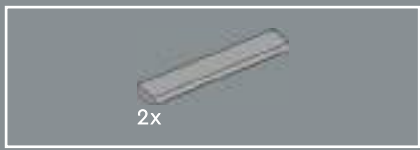

319

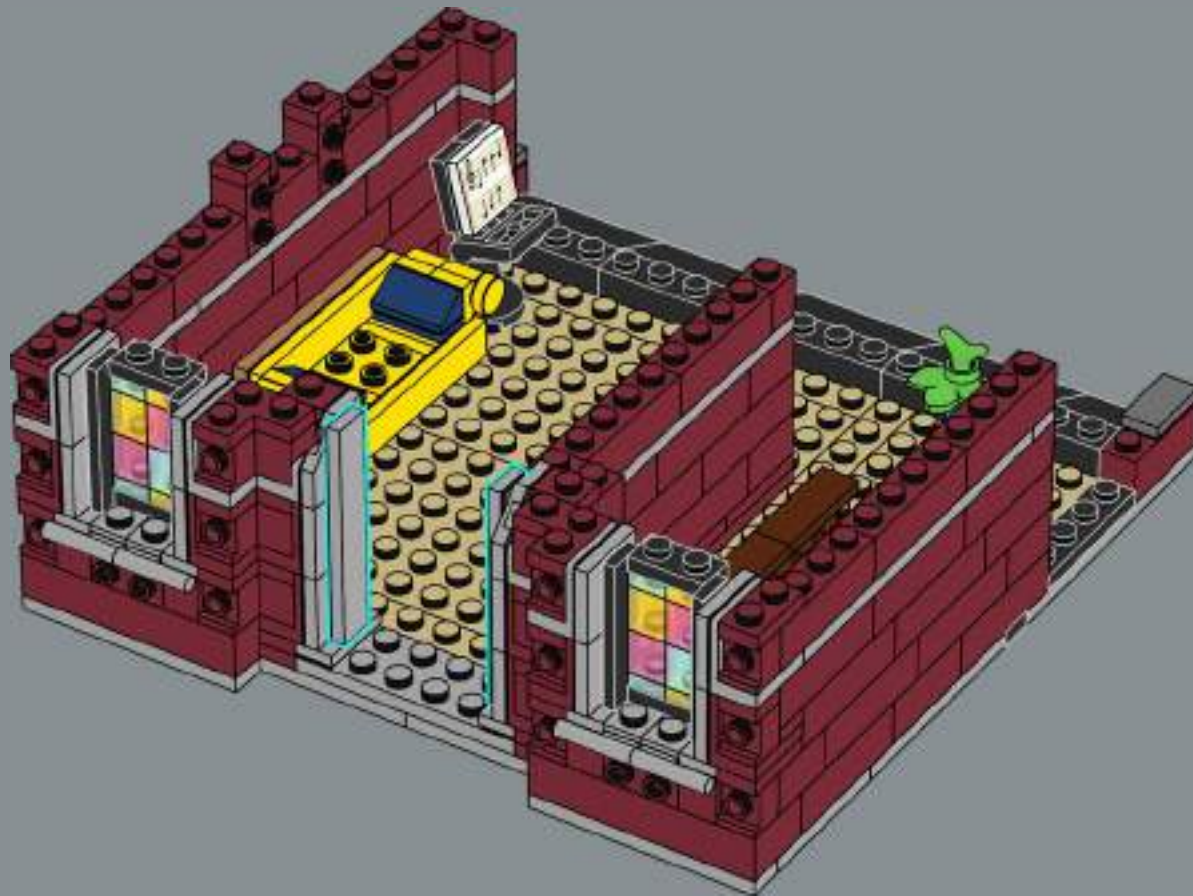



320



321

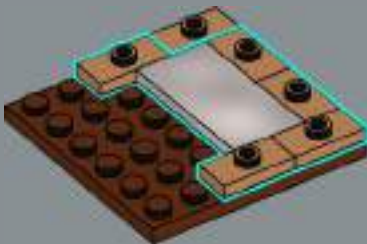

322

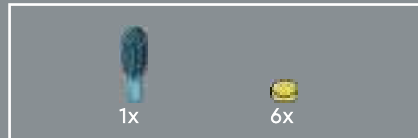
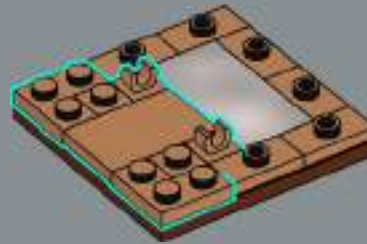

323



324

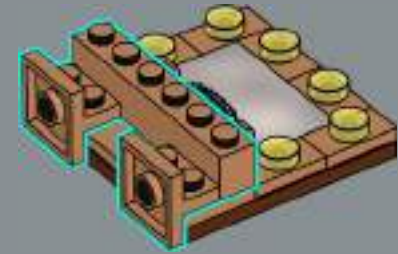

325

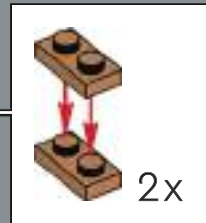

2x

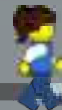



Before you take the stage, take a few minutes at the makeup table to be sure you will look your best under the bright lights.

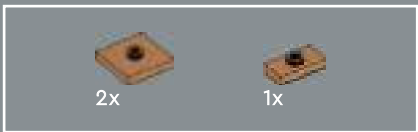

326

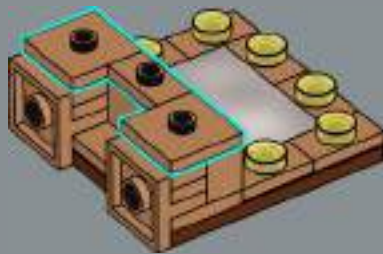

327

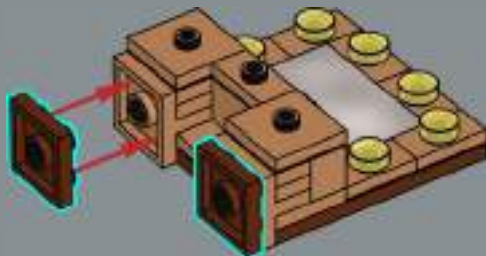

328

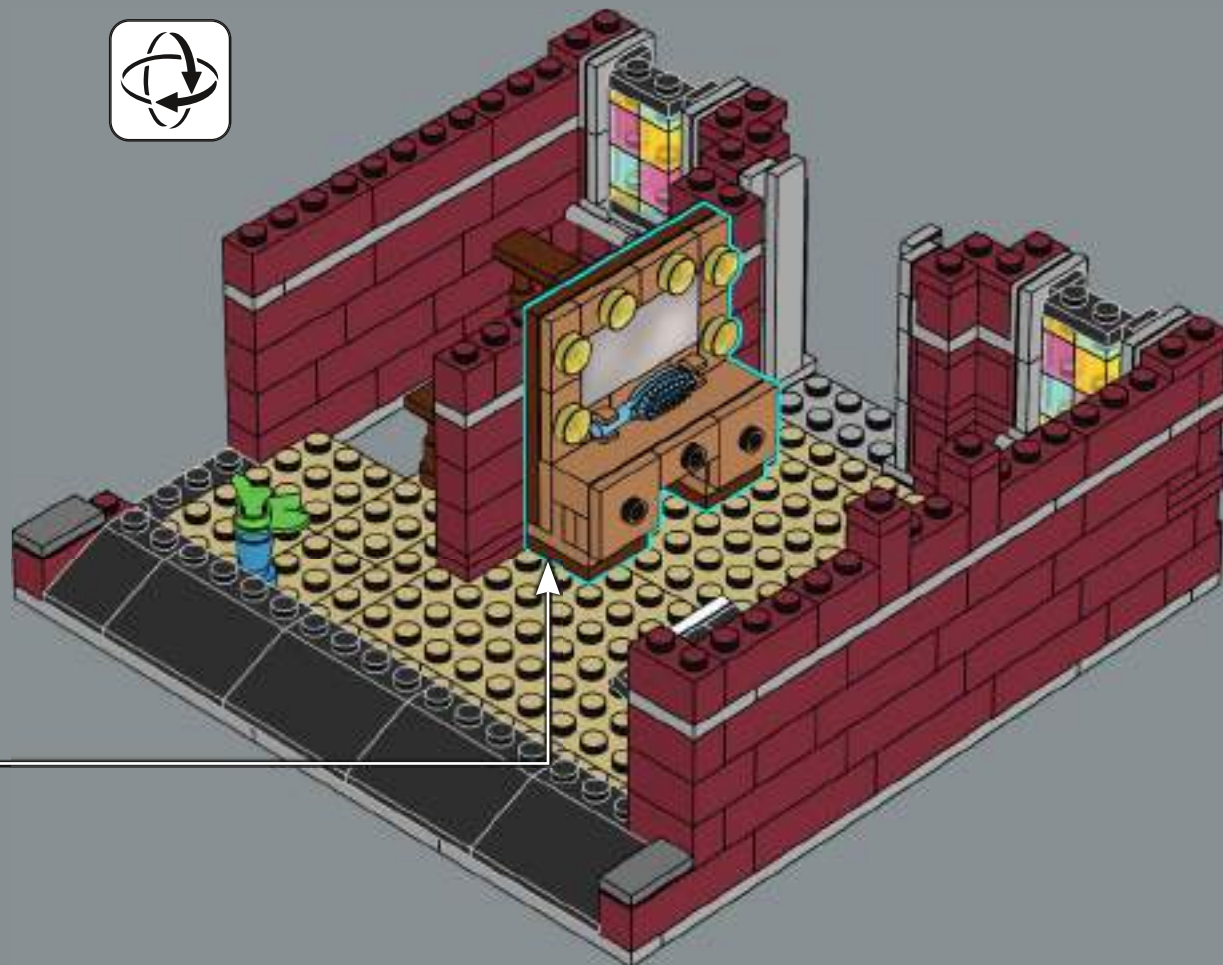

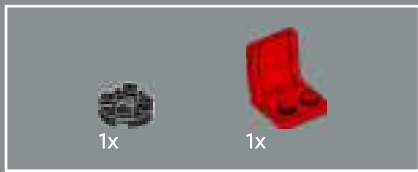

329

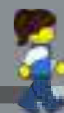



The magician found her trusty magical sidekick the rabbit at the LEGO® 10218 Pet Shop.



330

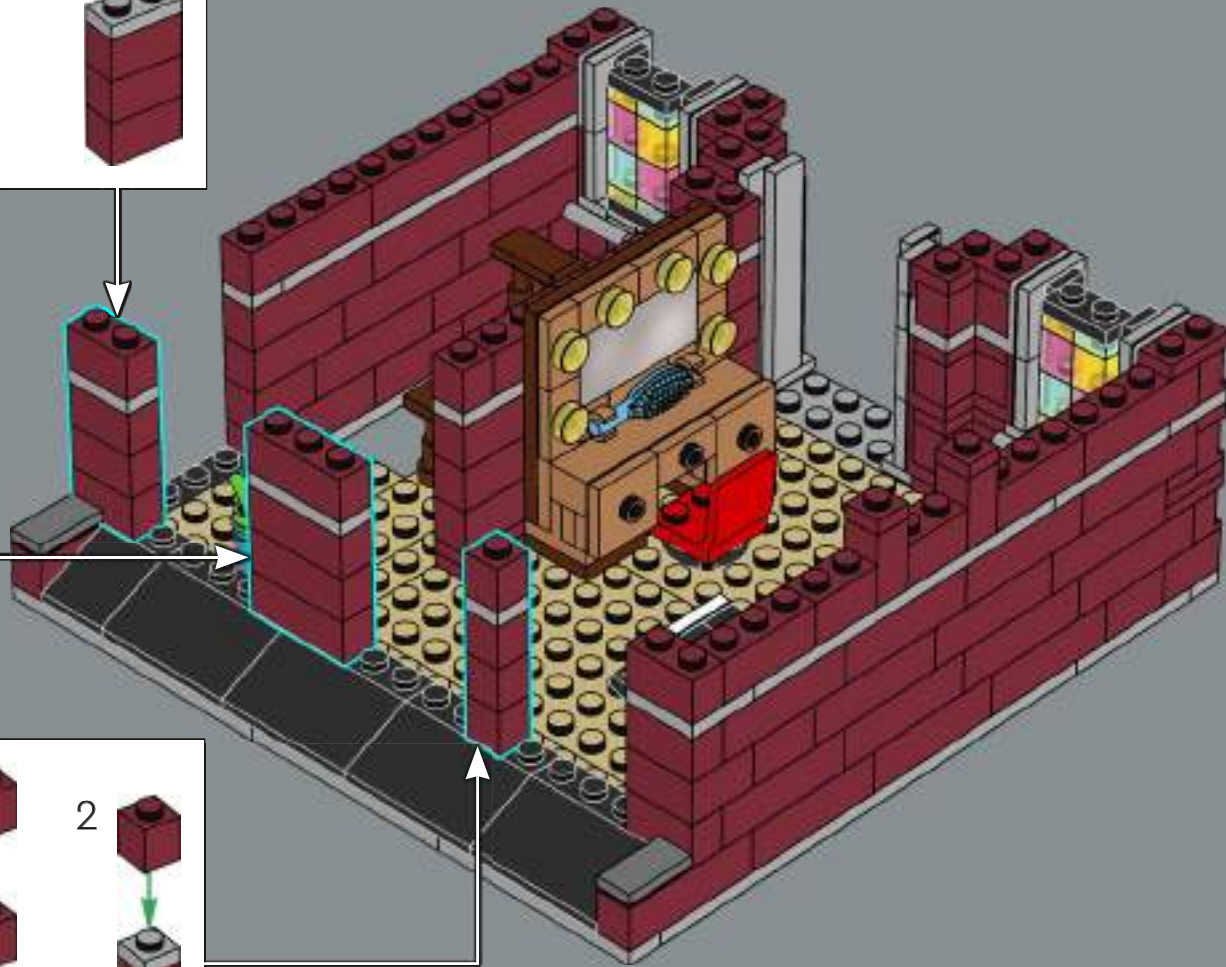
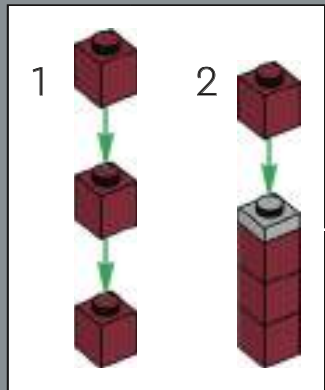
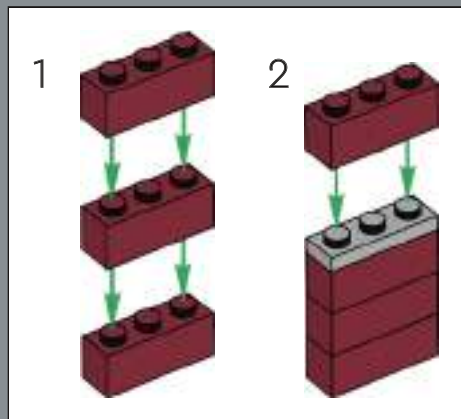
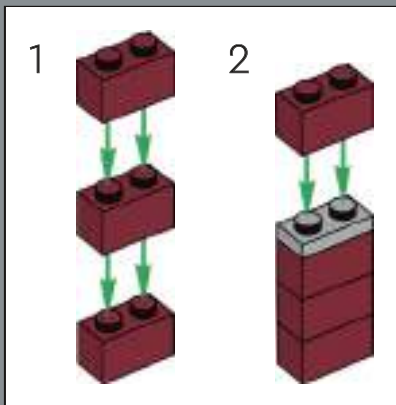

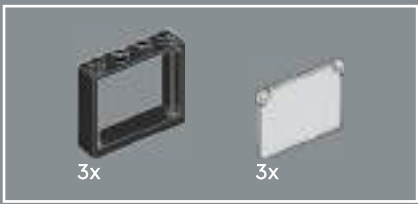

331

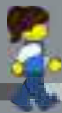
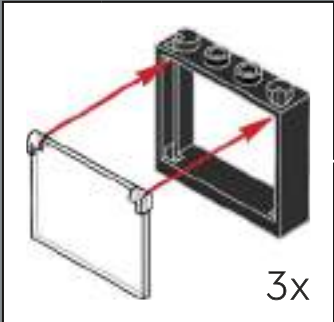

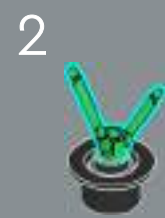
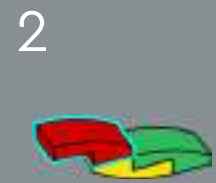
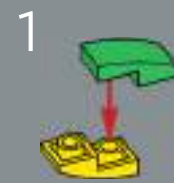



332





333

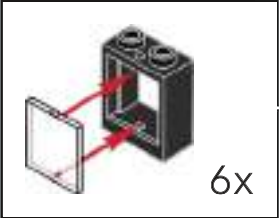
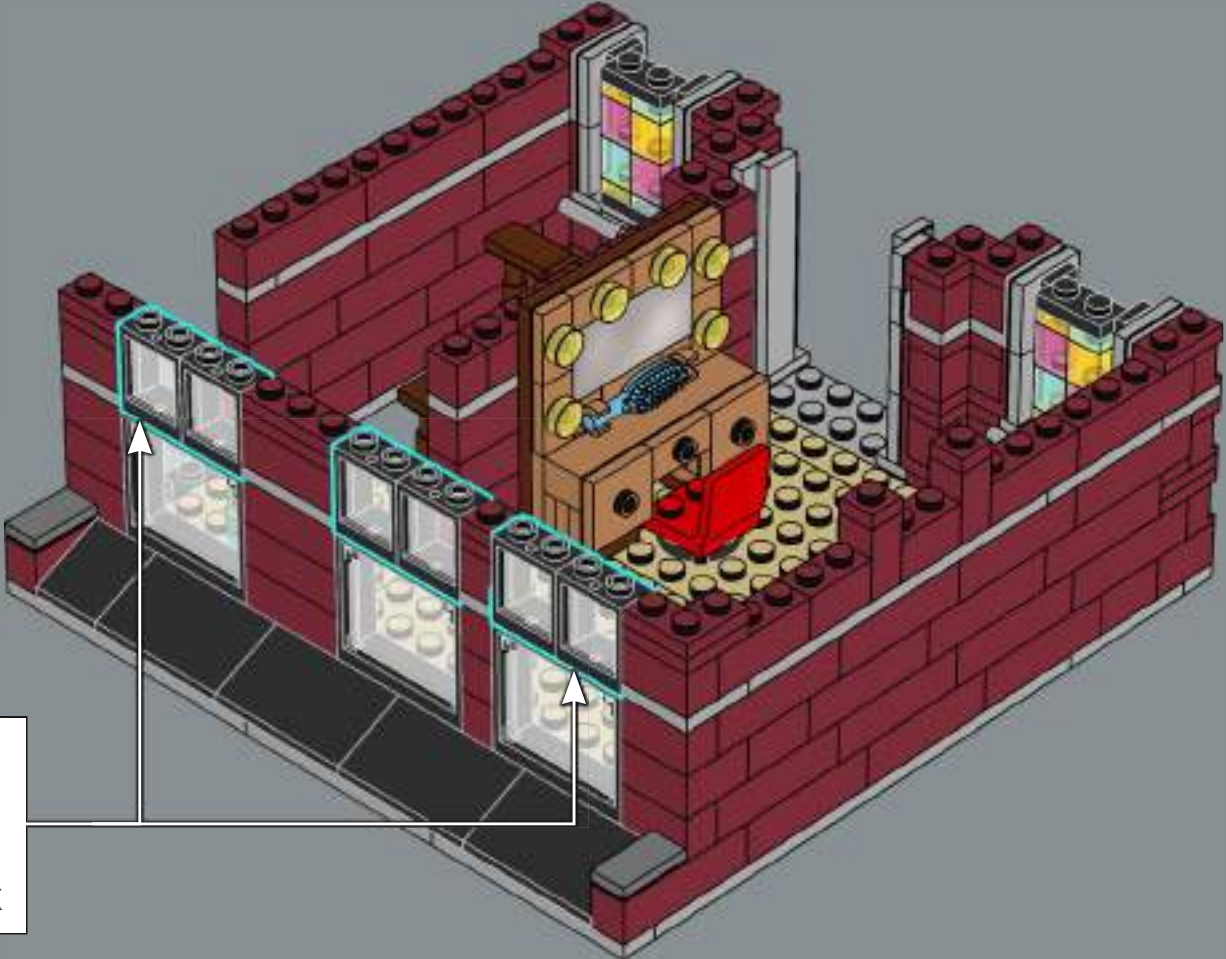

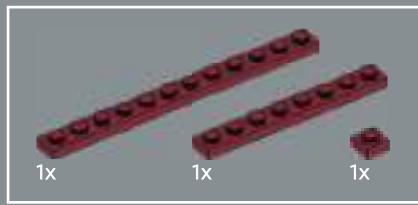

334

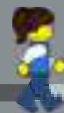

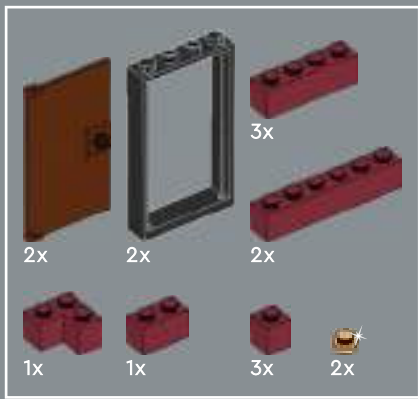

335

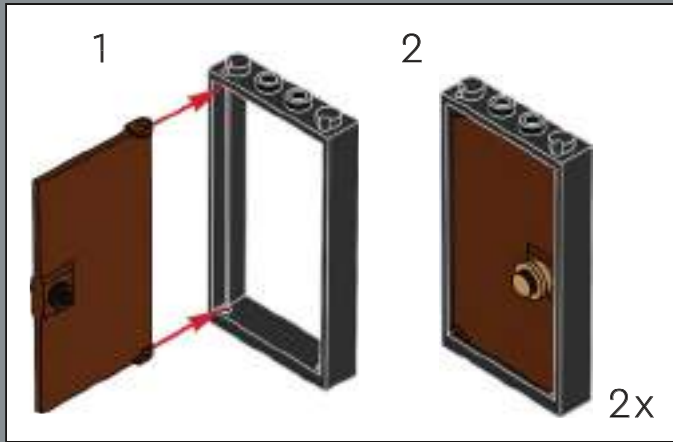

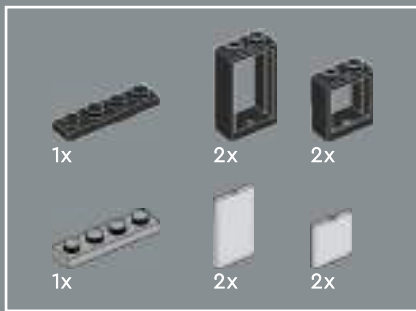

336

1



2



3



4

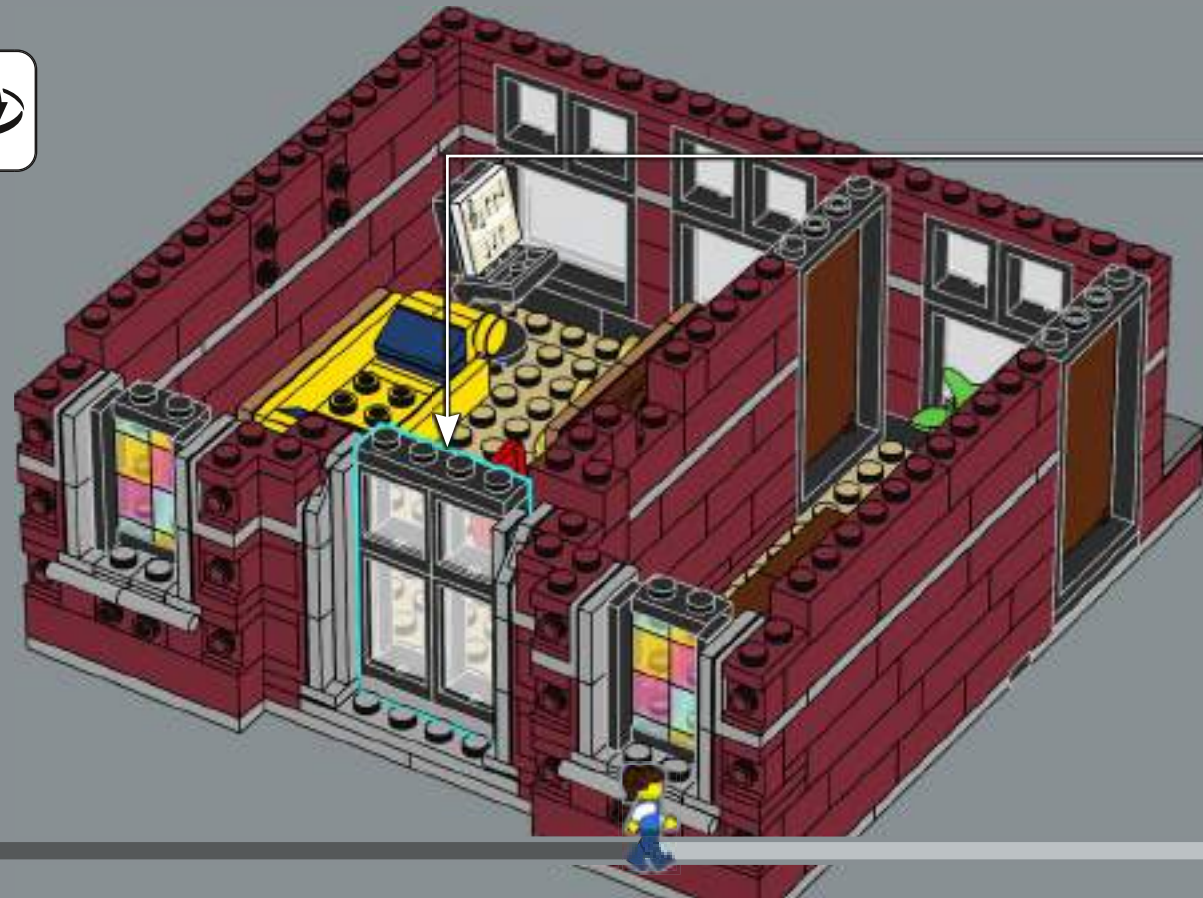
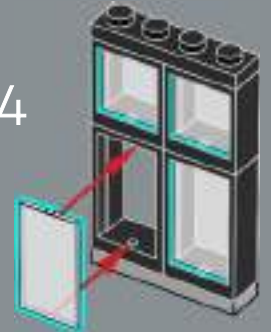



337

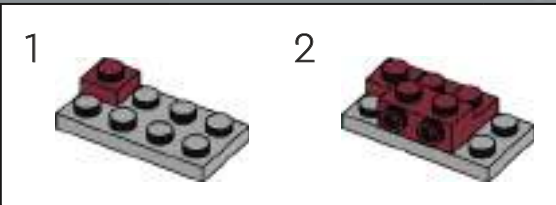
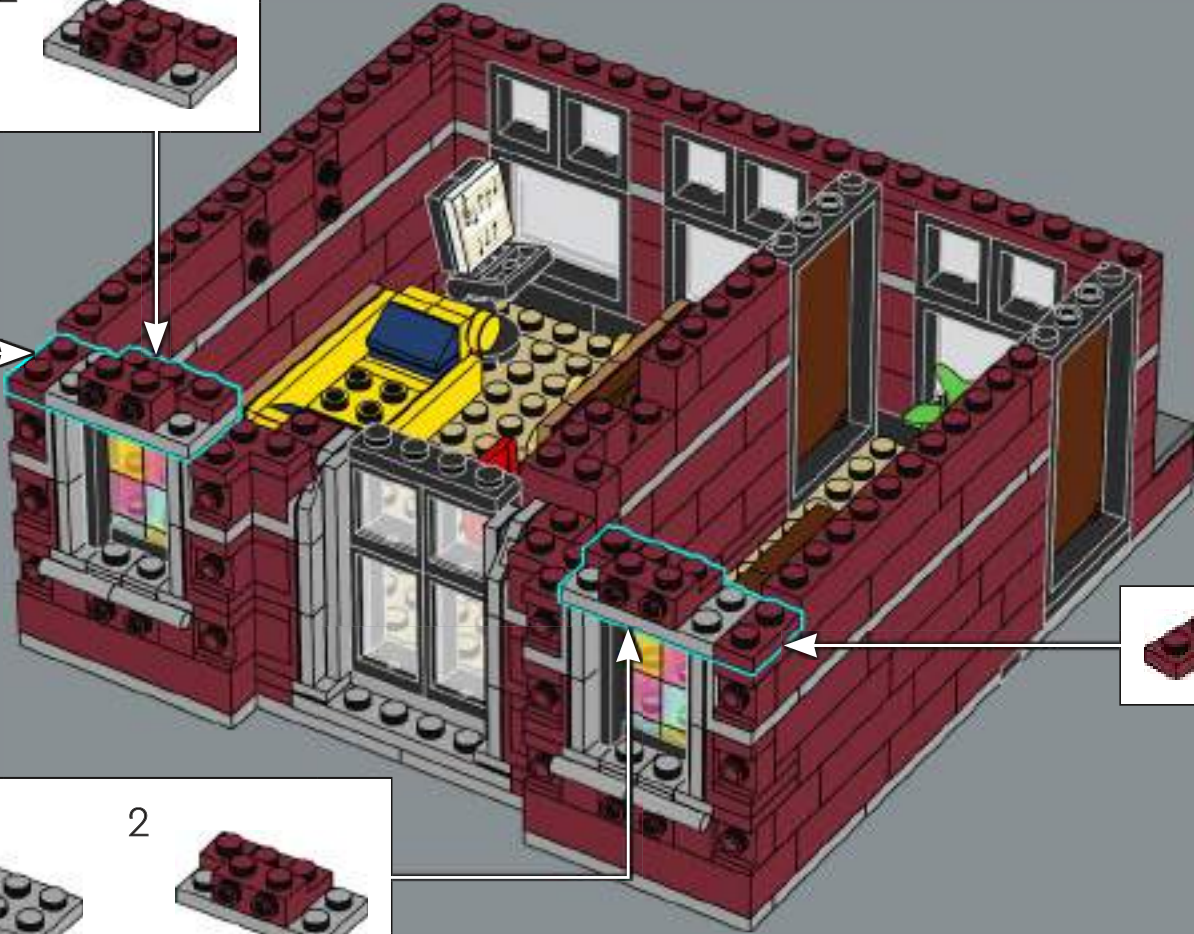
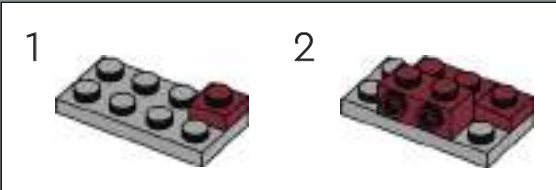

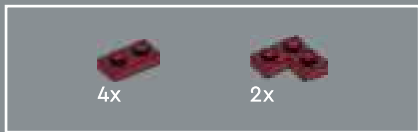

338

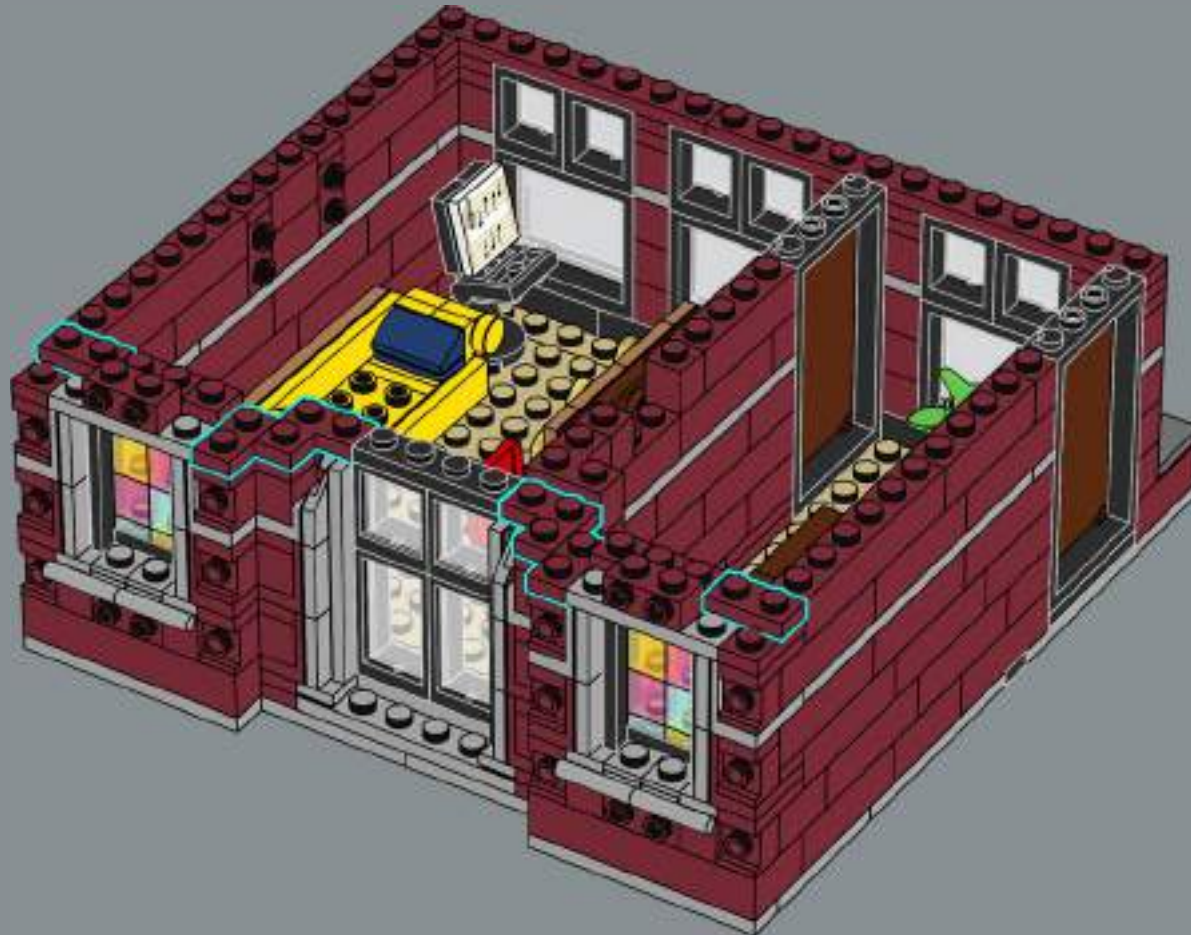

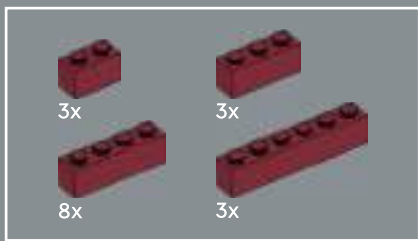

339

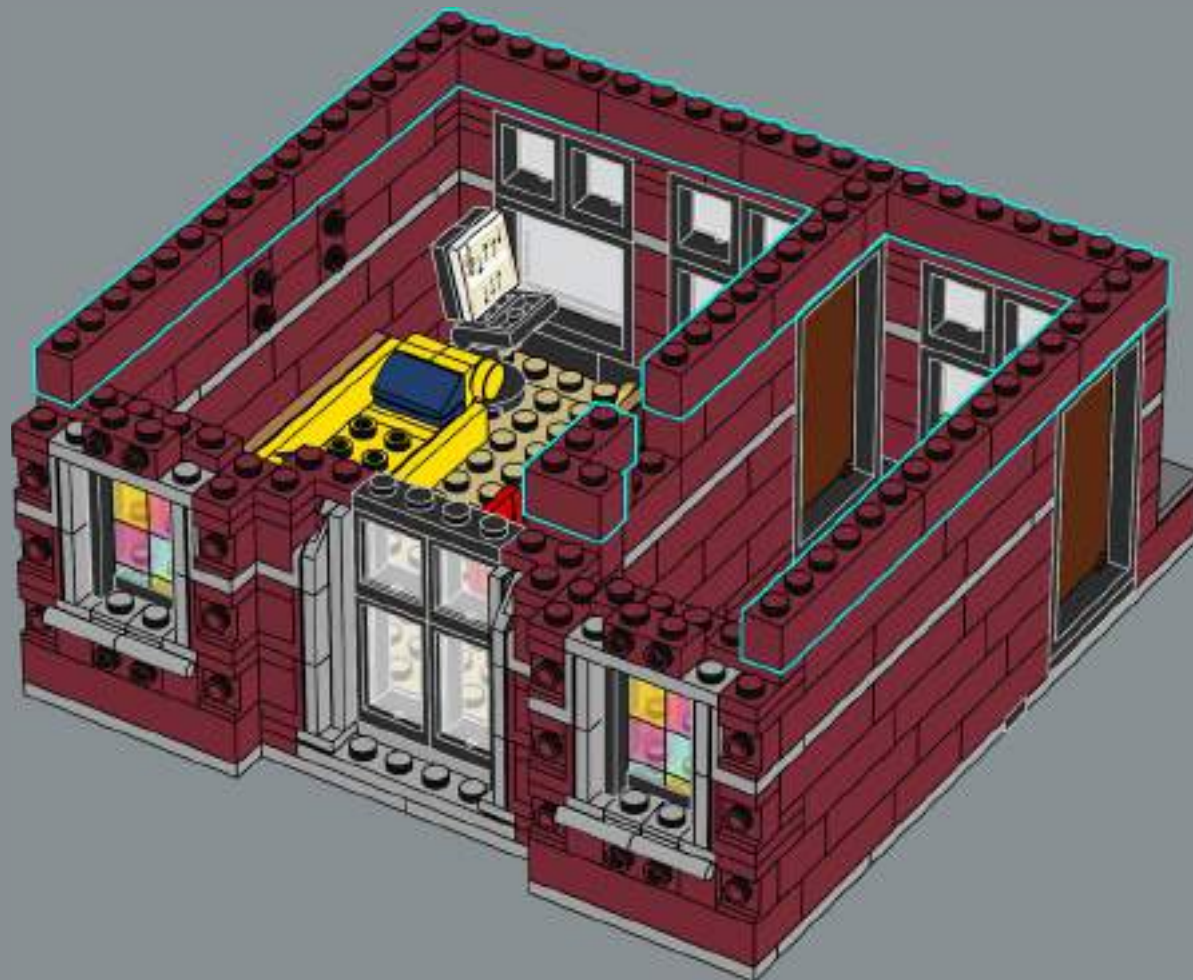

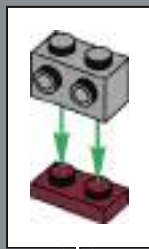
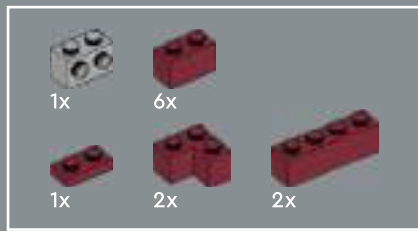

340

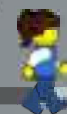
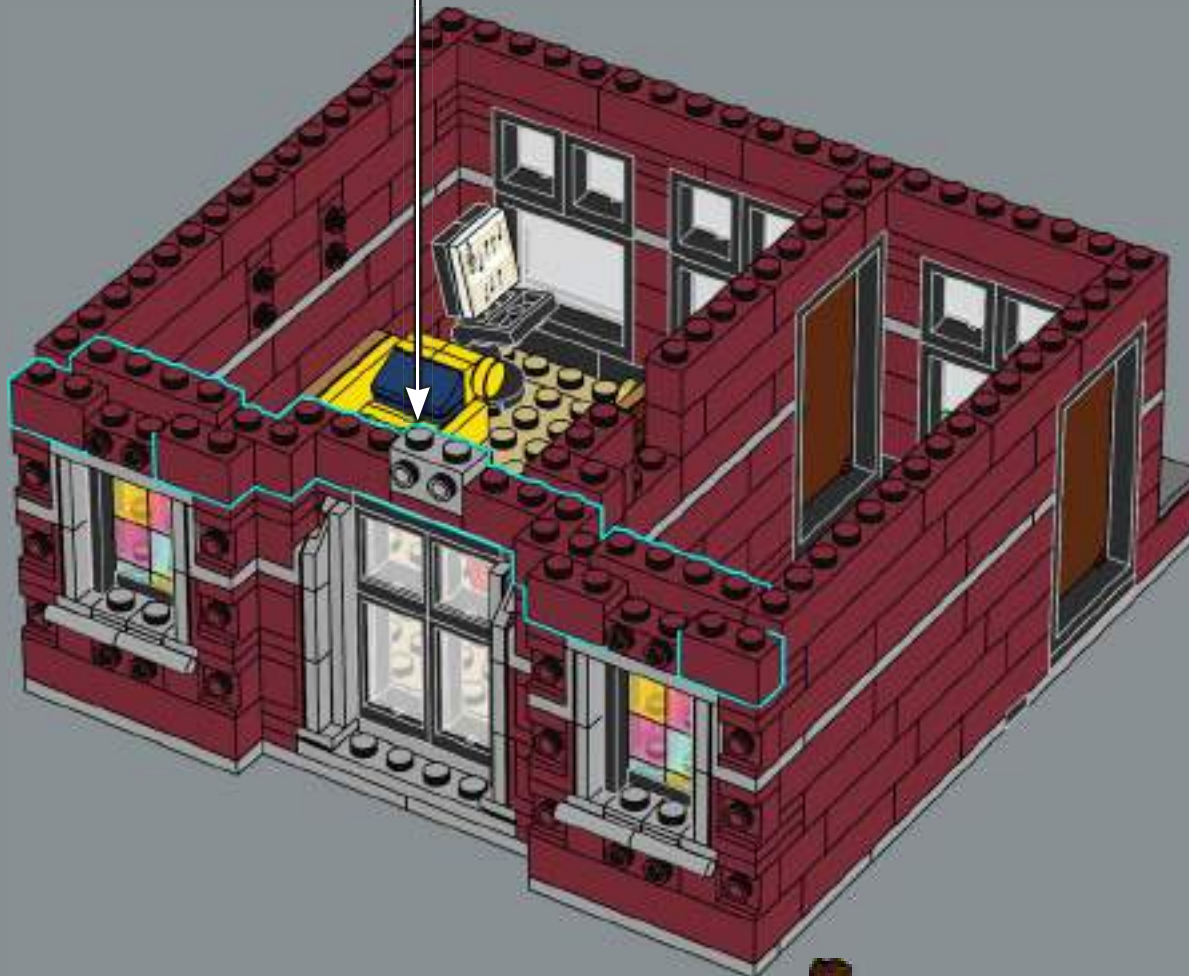



341

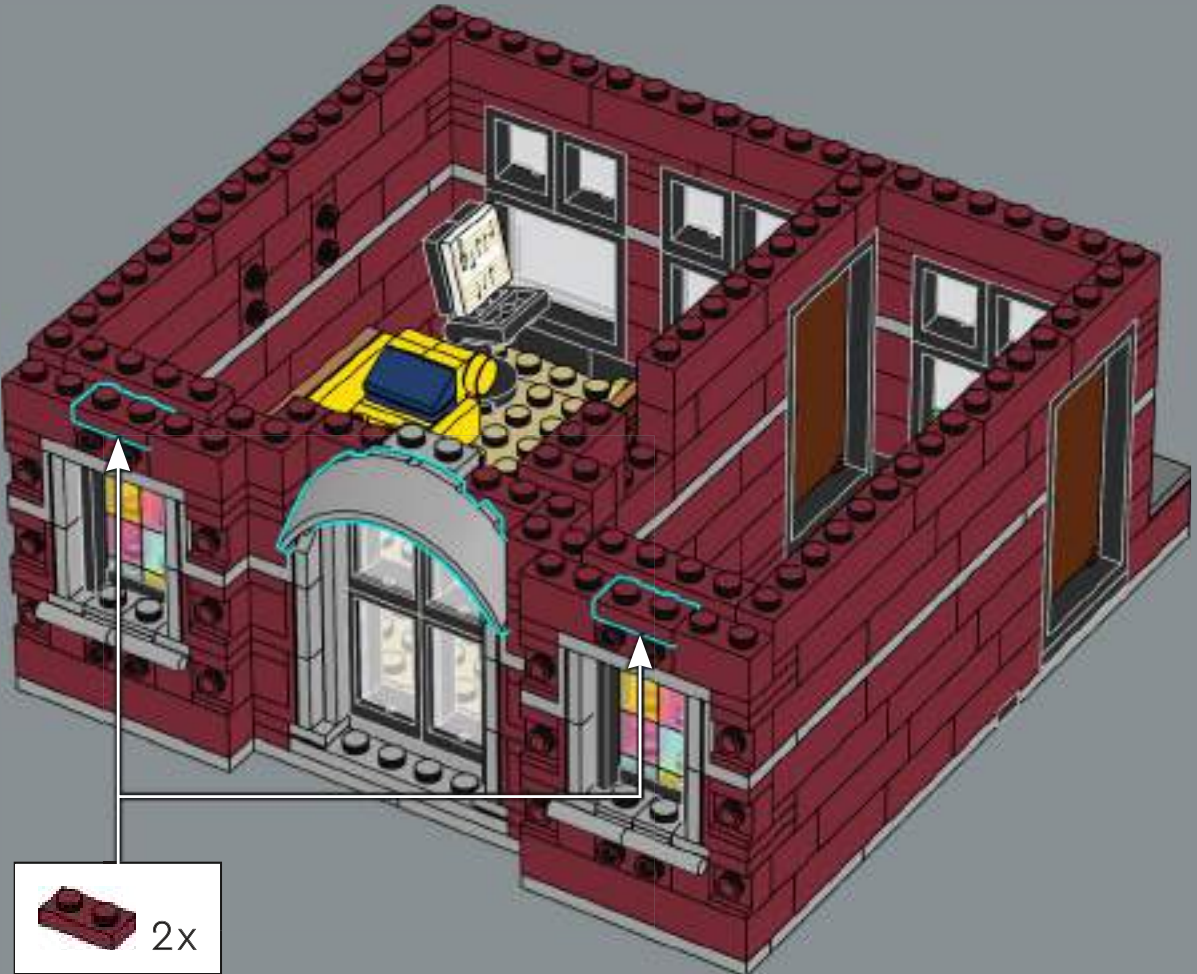



342

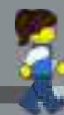
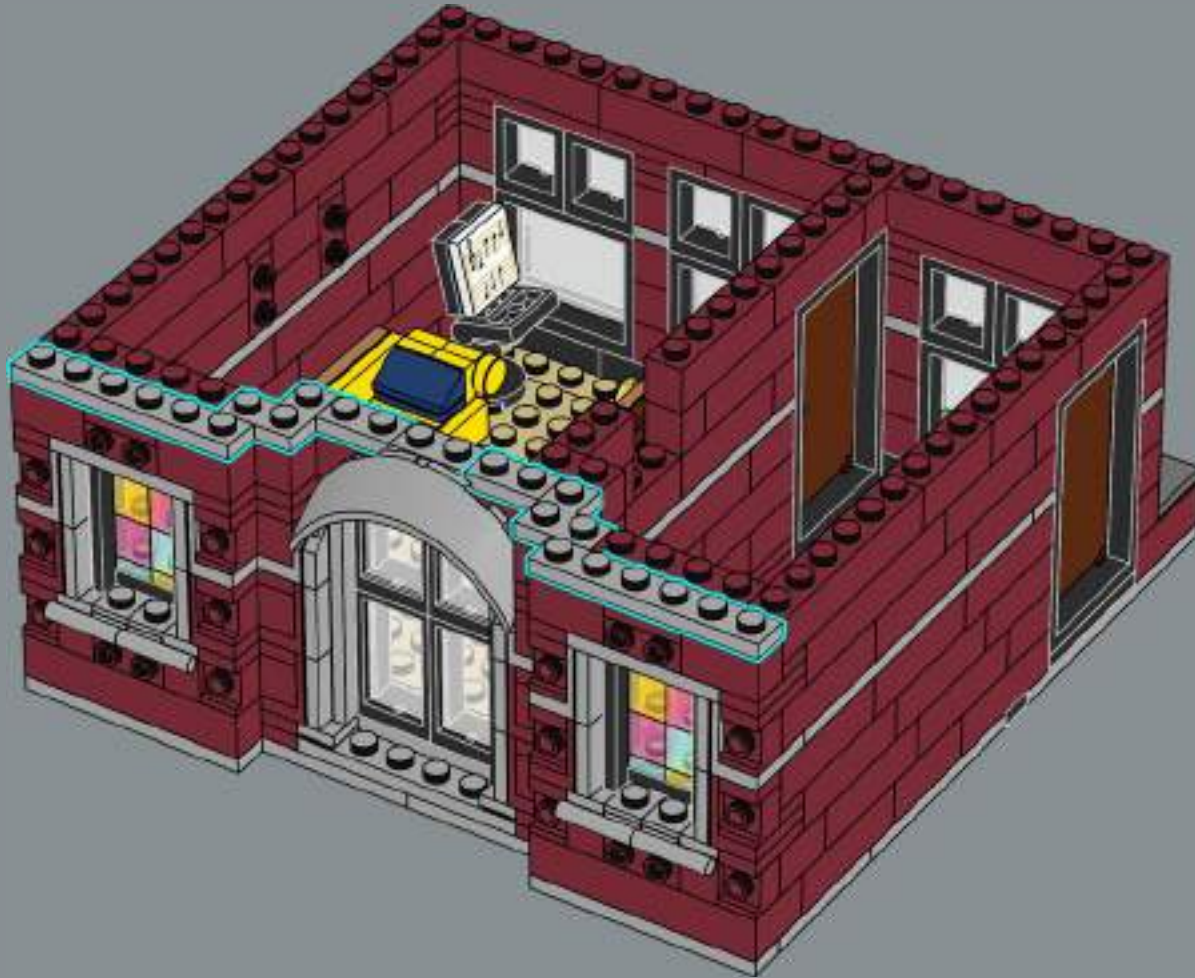

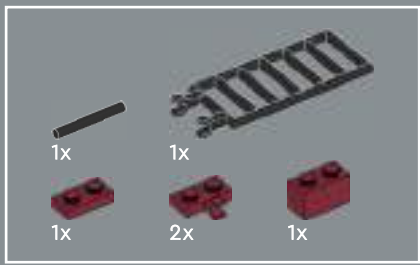

343

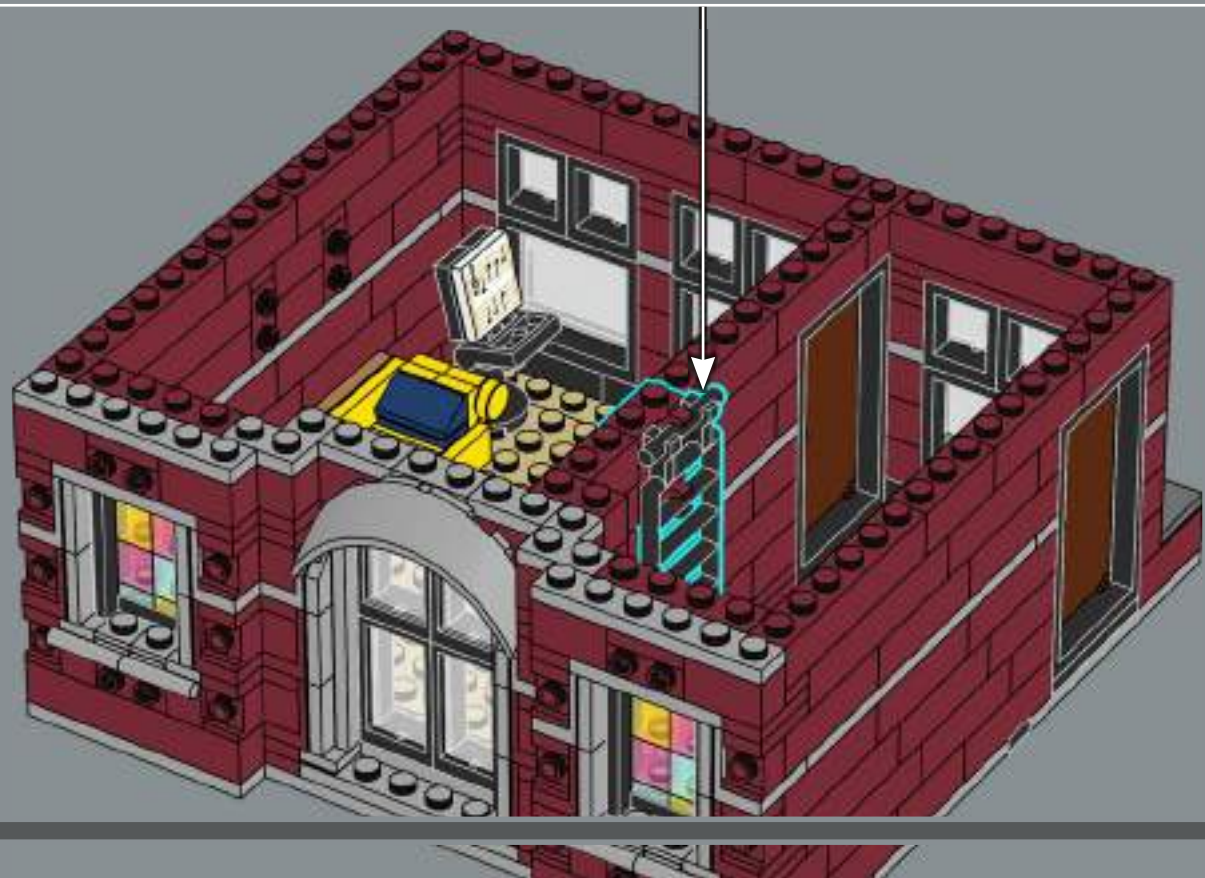
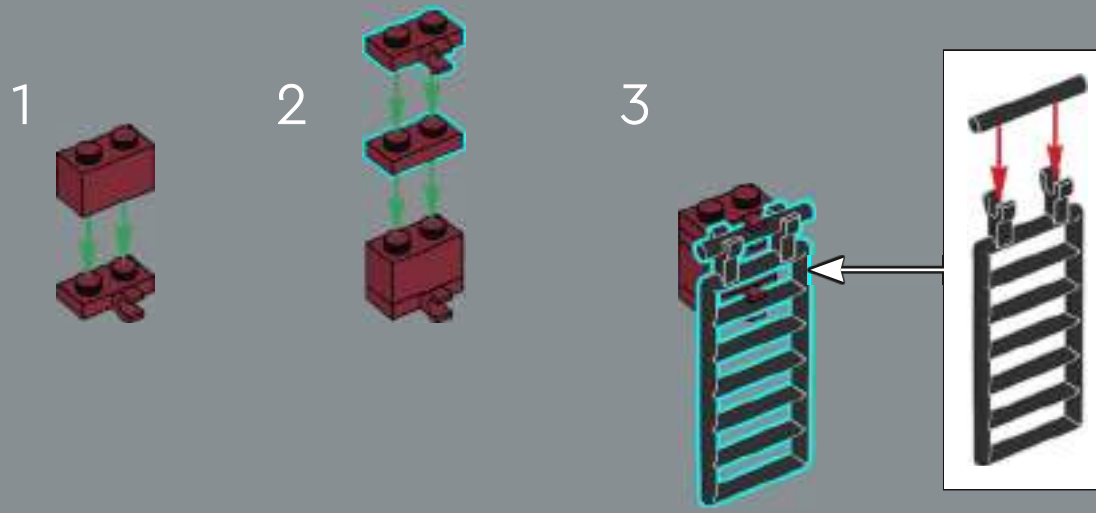

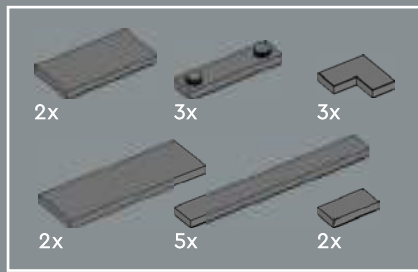

344

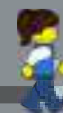
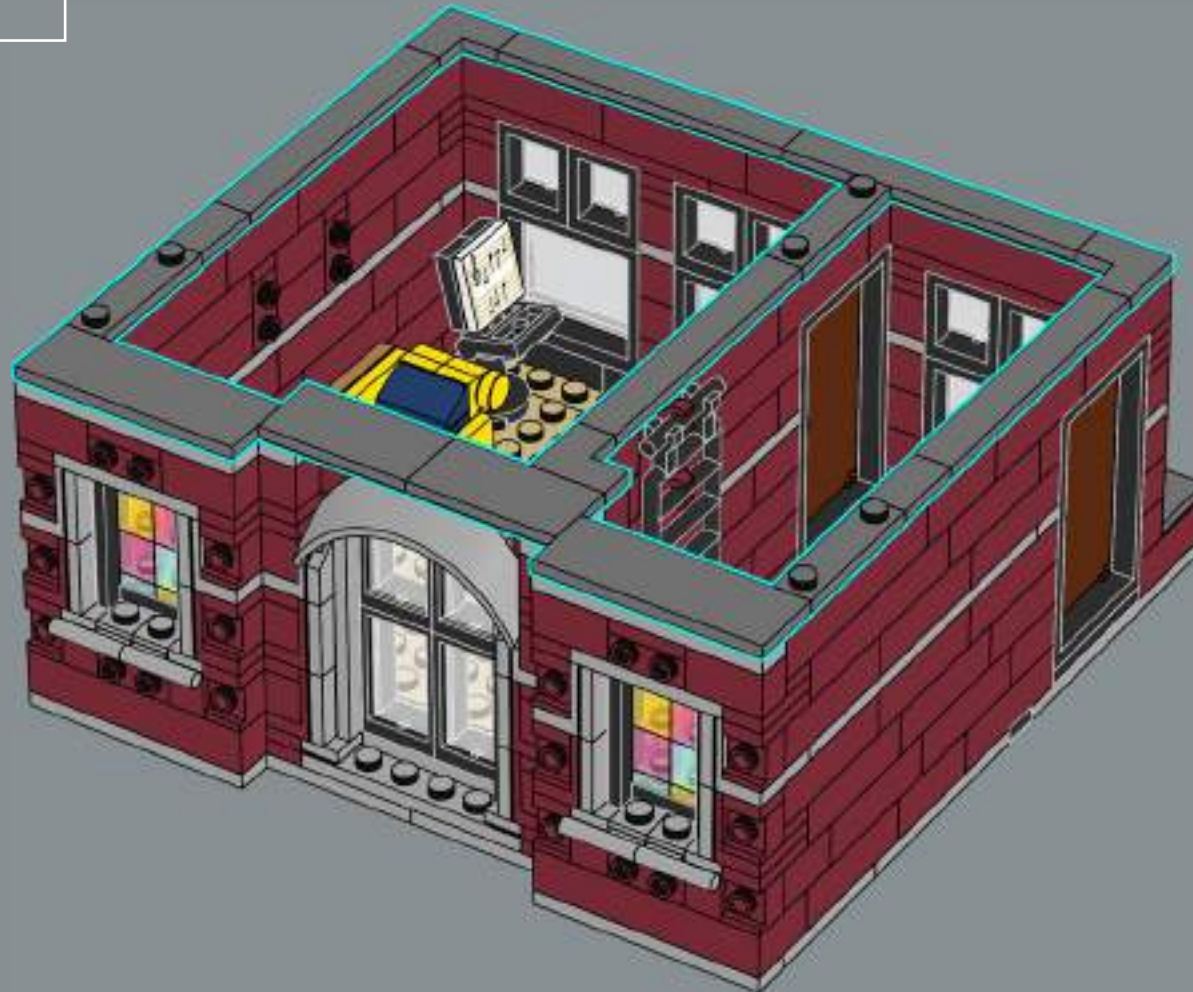



345

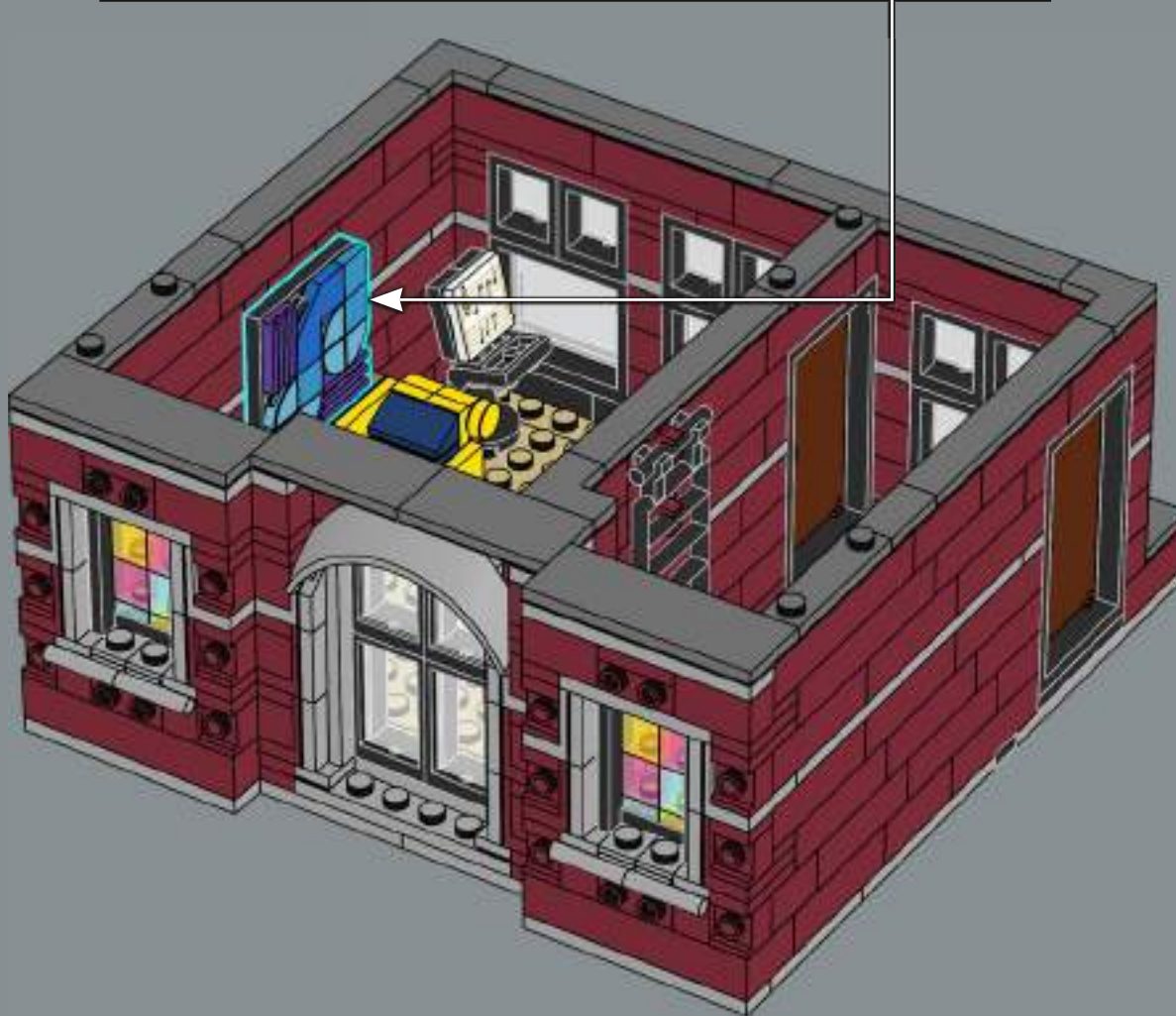

This painting of 'The Blues' was sold just down the street, at the Art Gallery in the LEGO® 10297 Boutique Hotel.

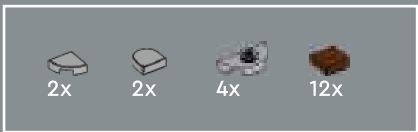

346





347

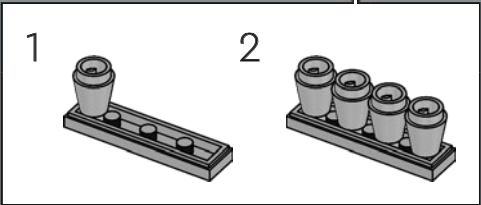
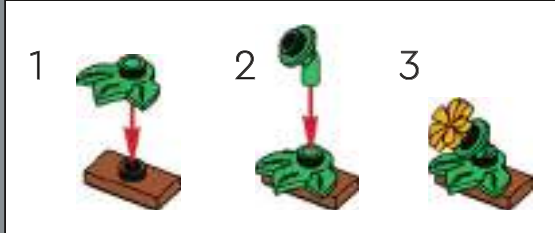

348



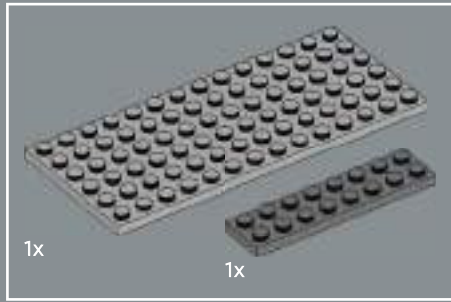

349

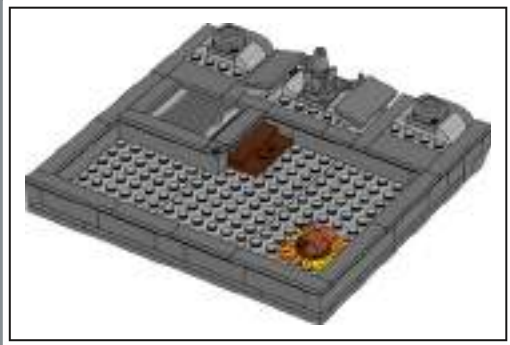
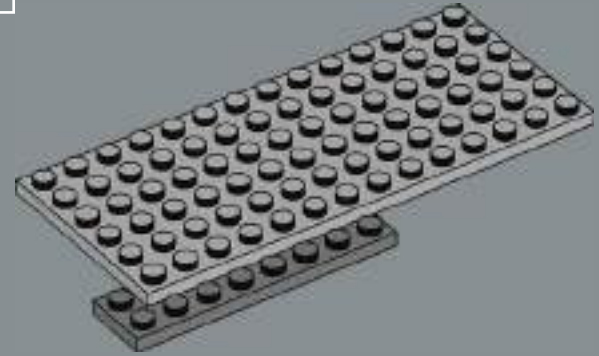

350

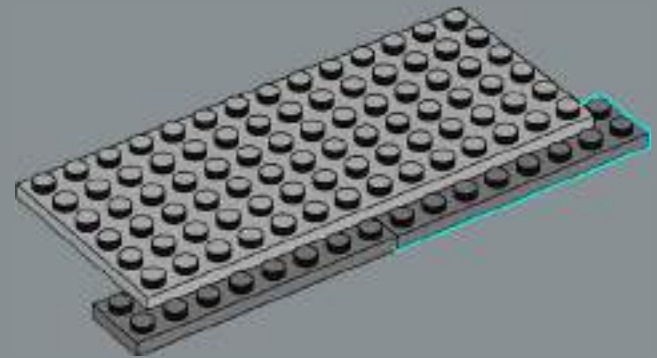

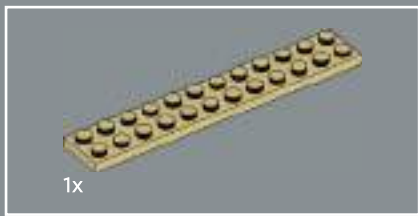

351

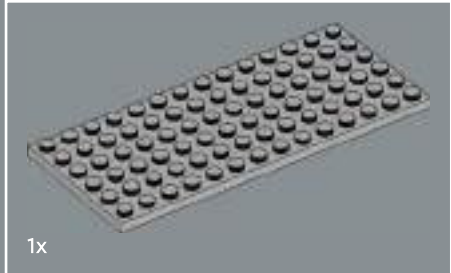
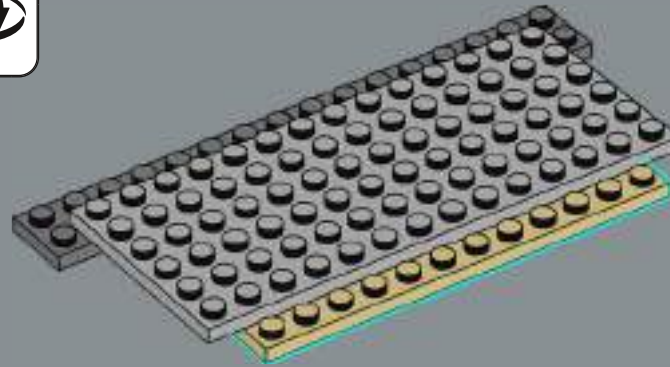

352

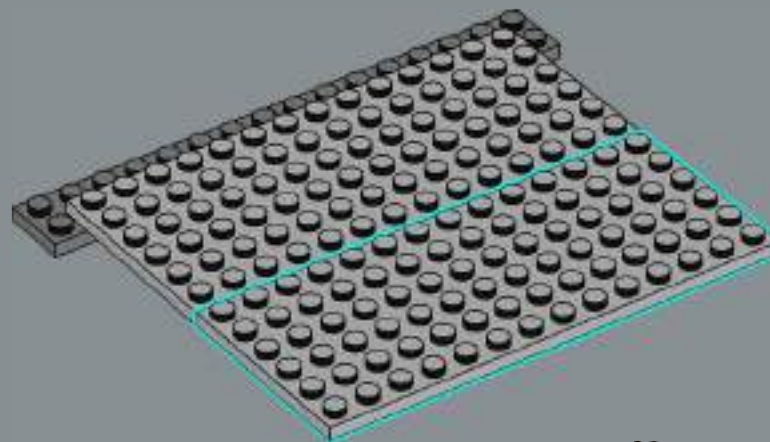



353

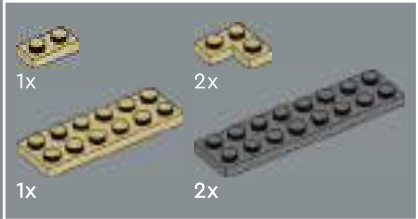
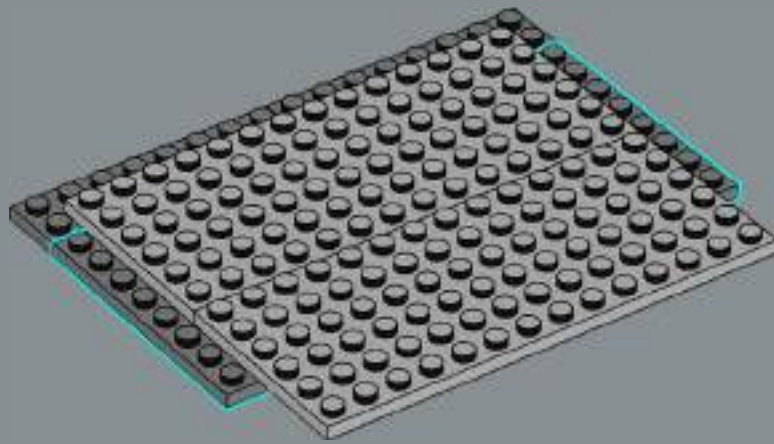

354

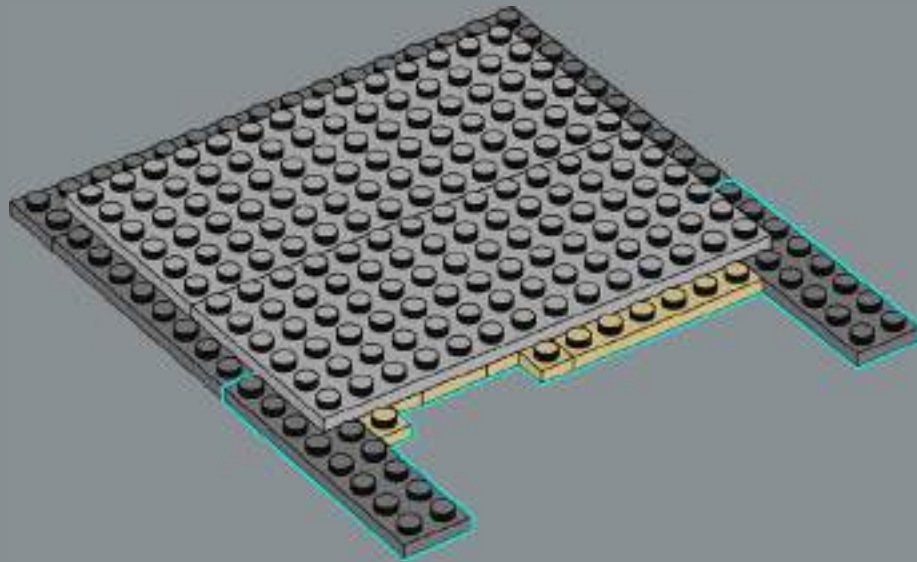

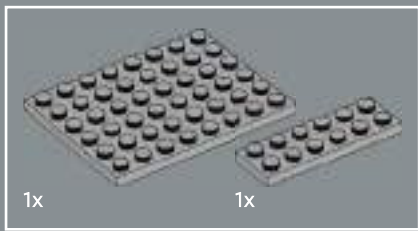

355

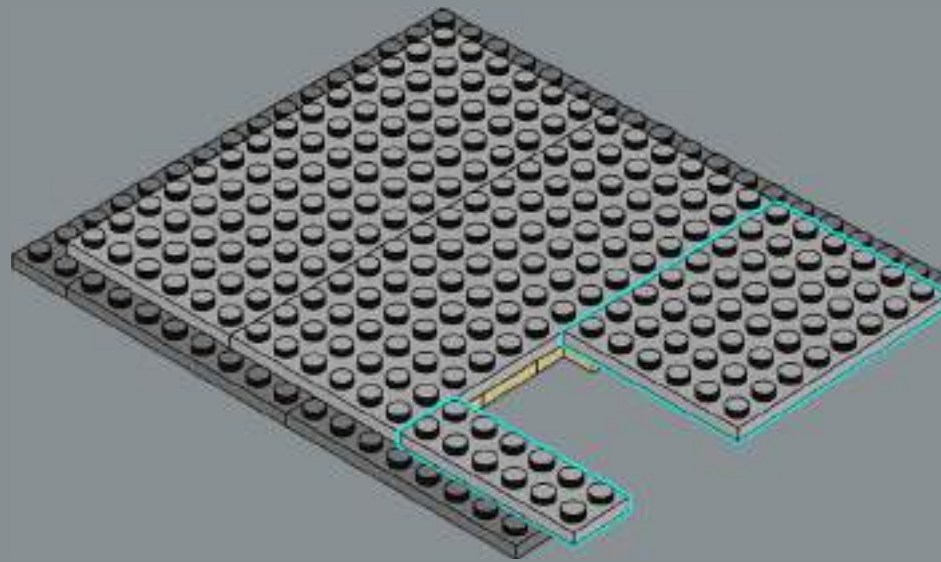

356

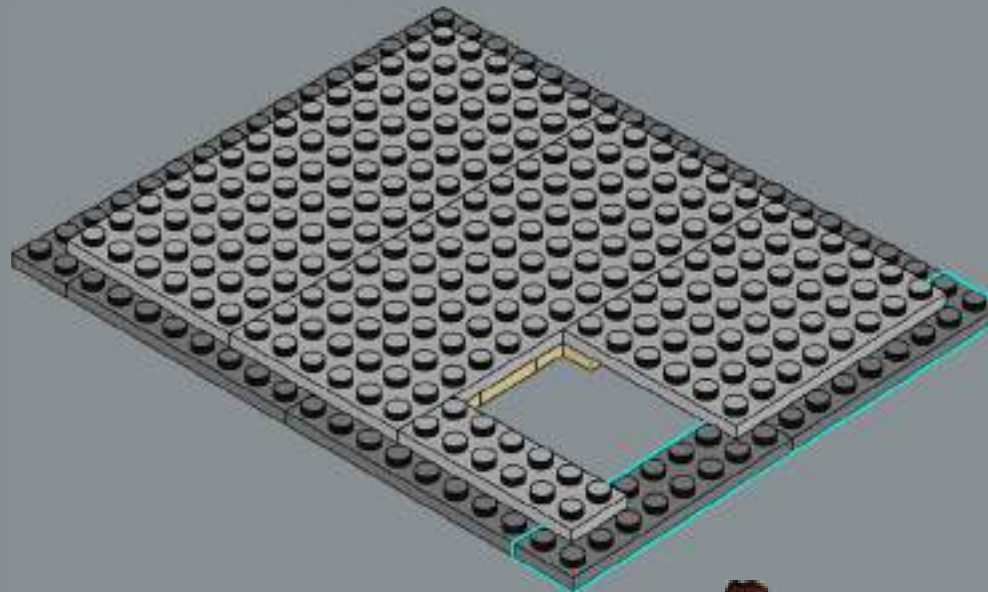

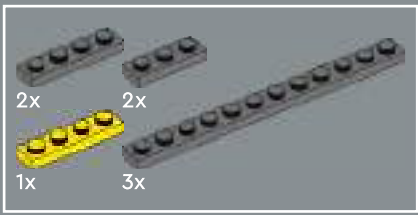

357

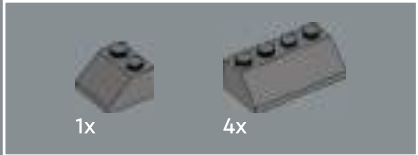
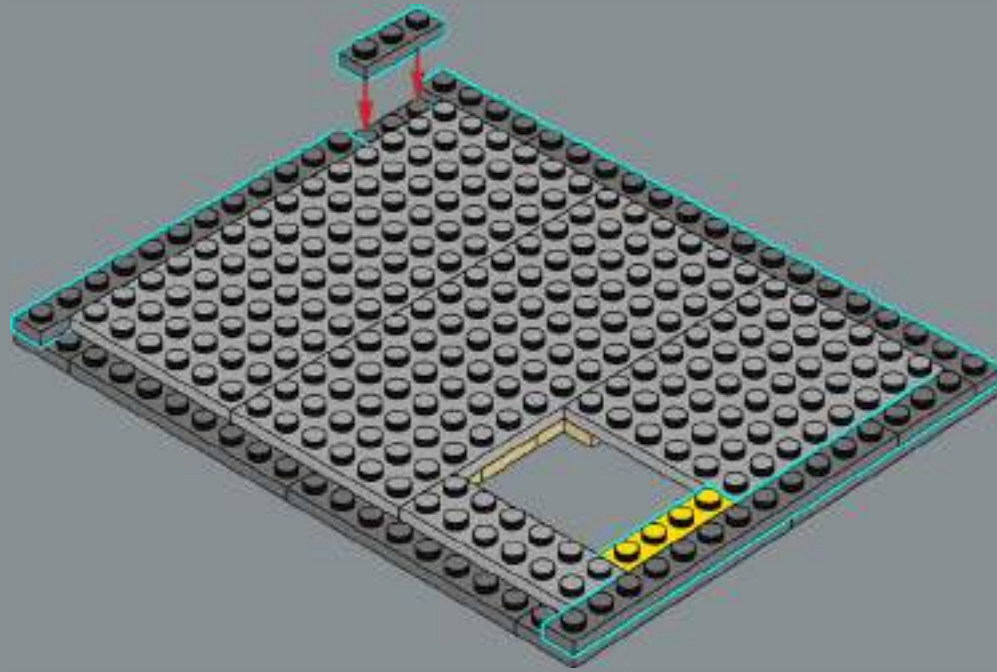

358

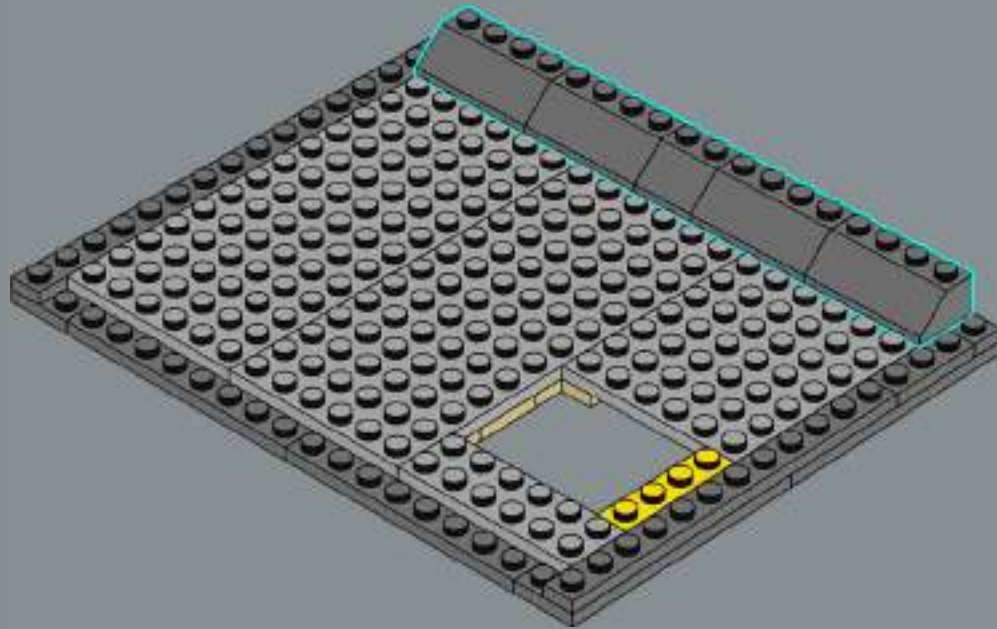

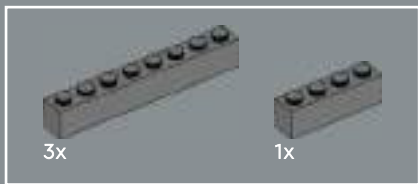

359

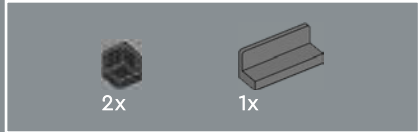
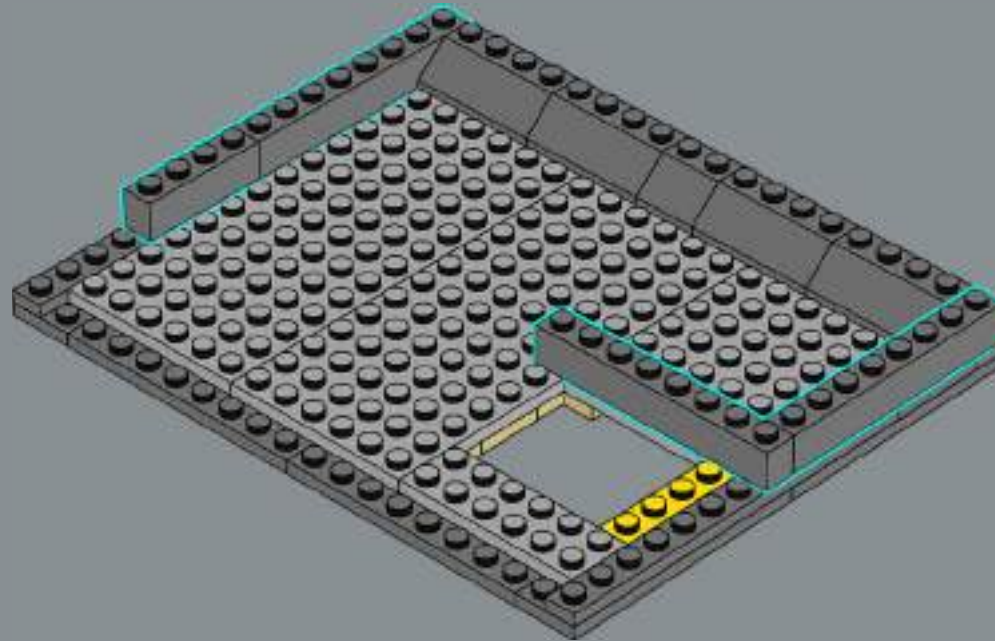

360

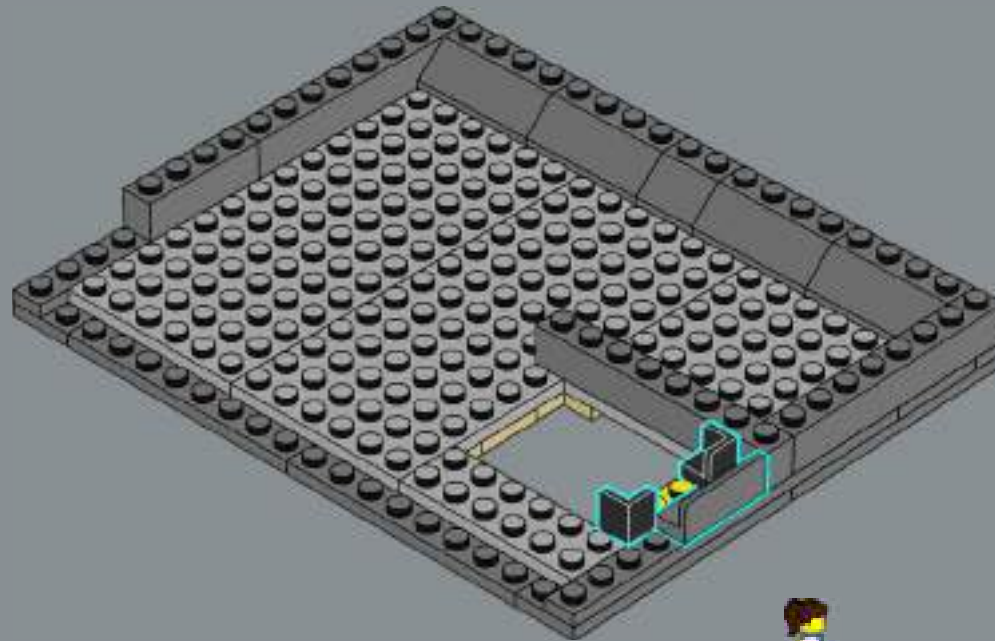

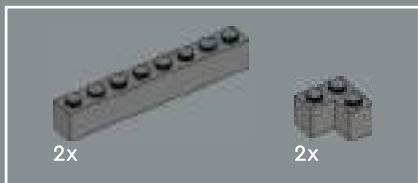

361

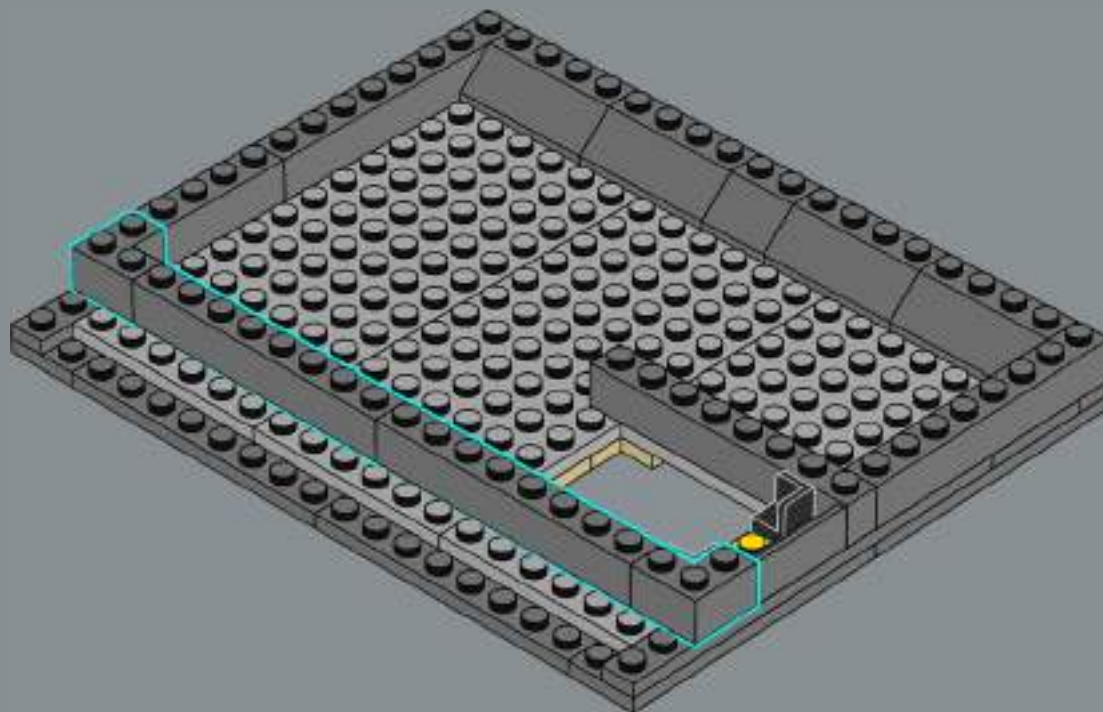

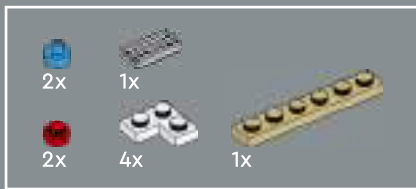

362

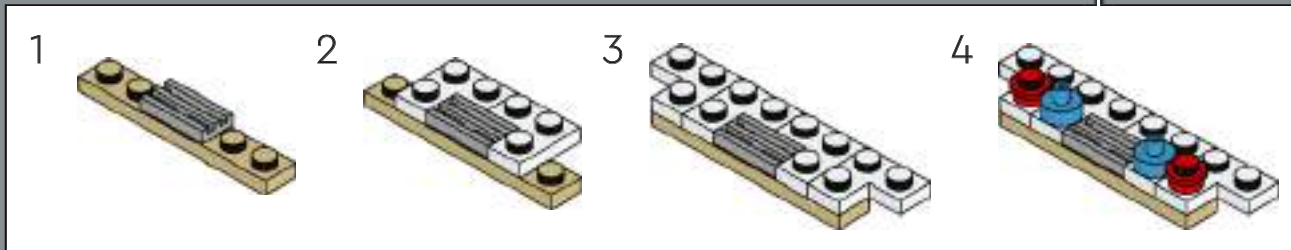
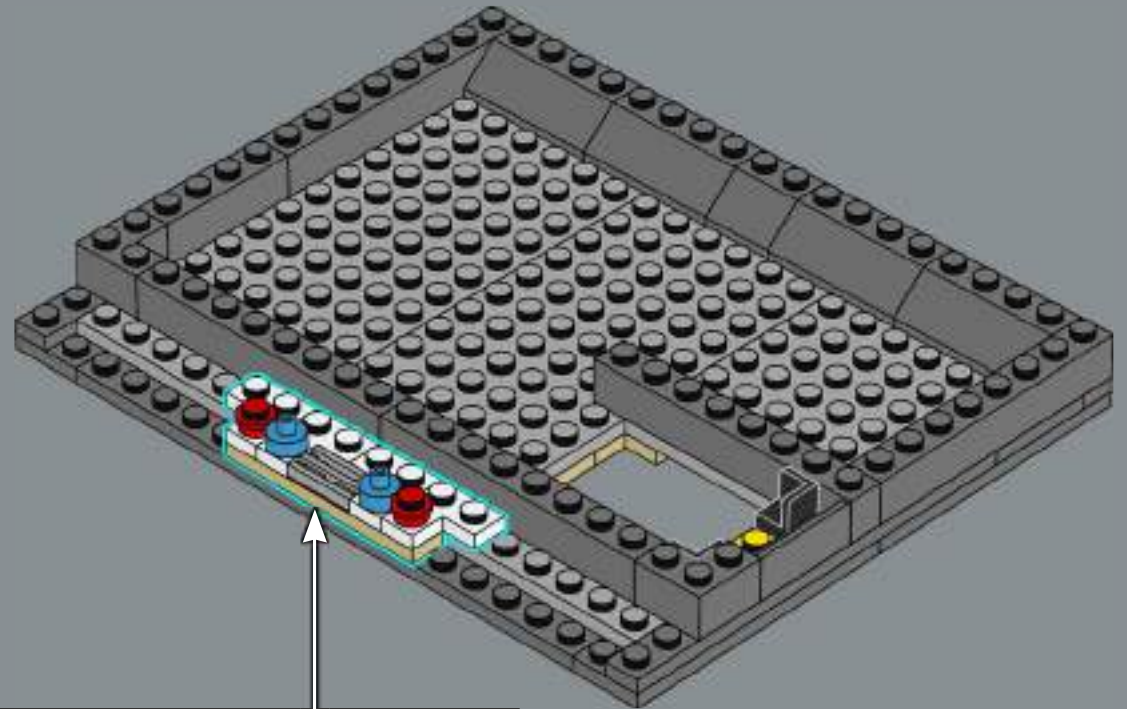



363

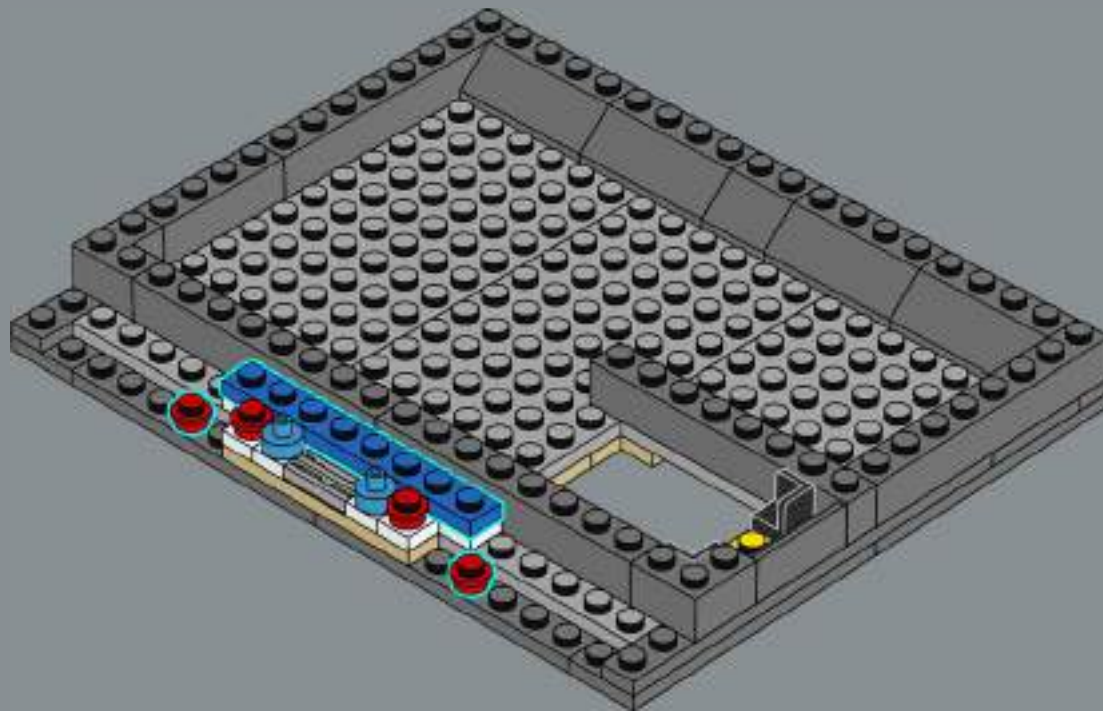

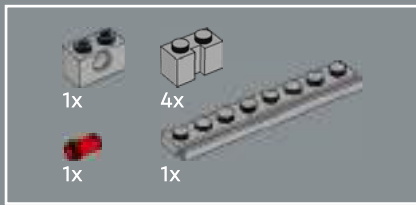

364

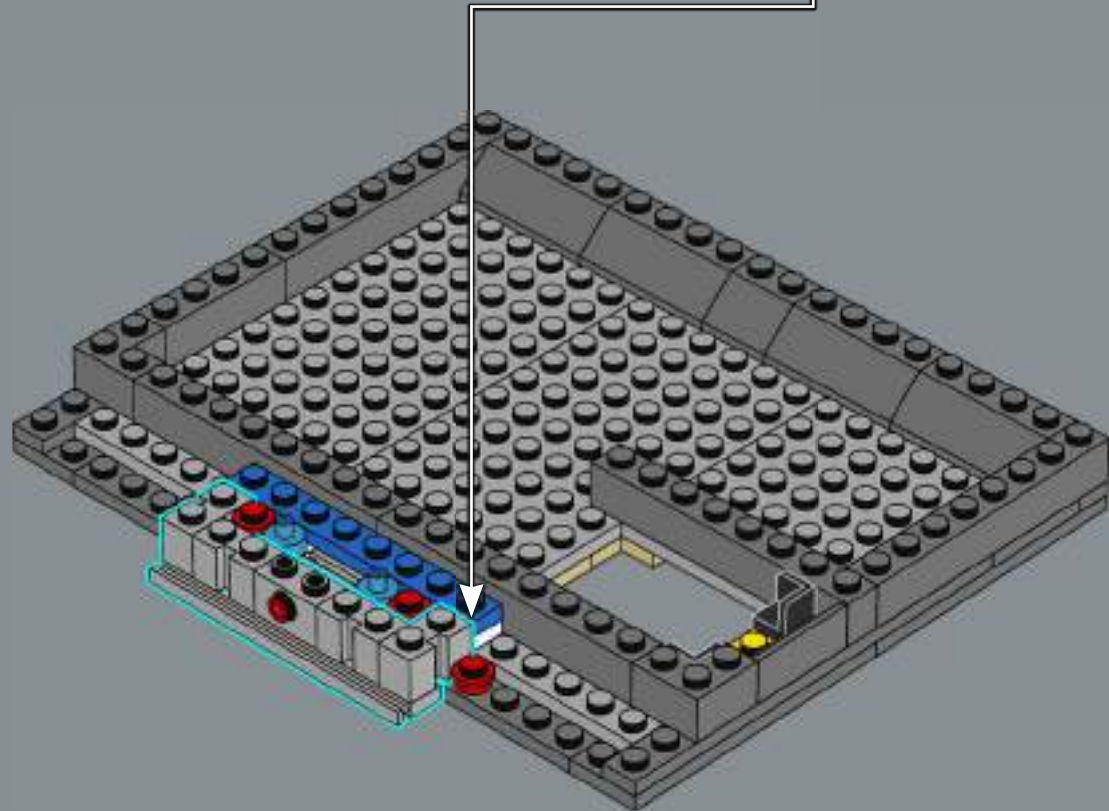
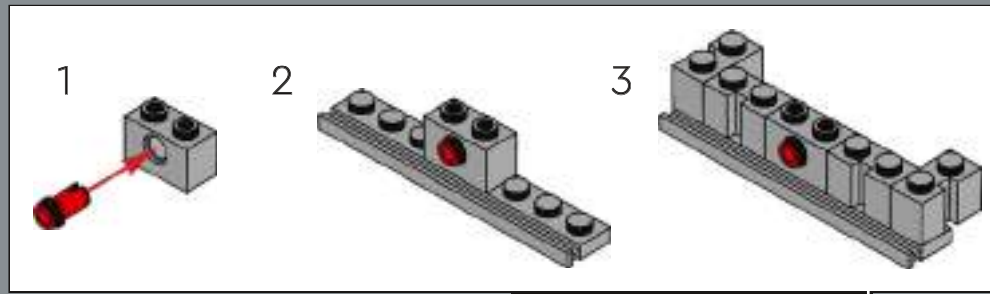



365

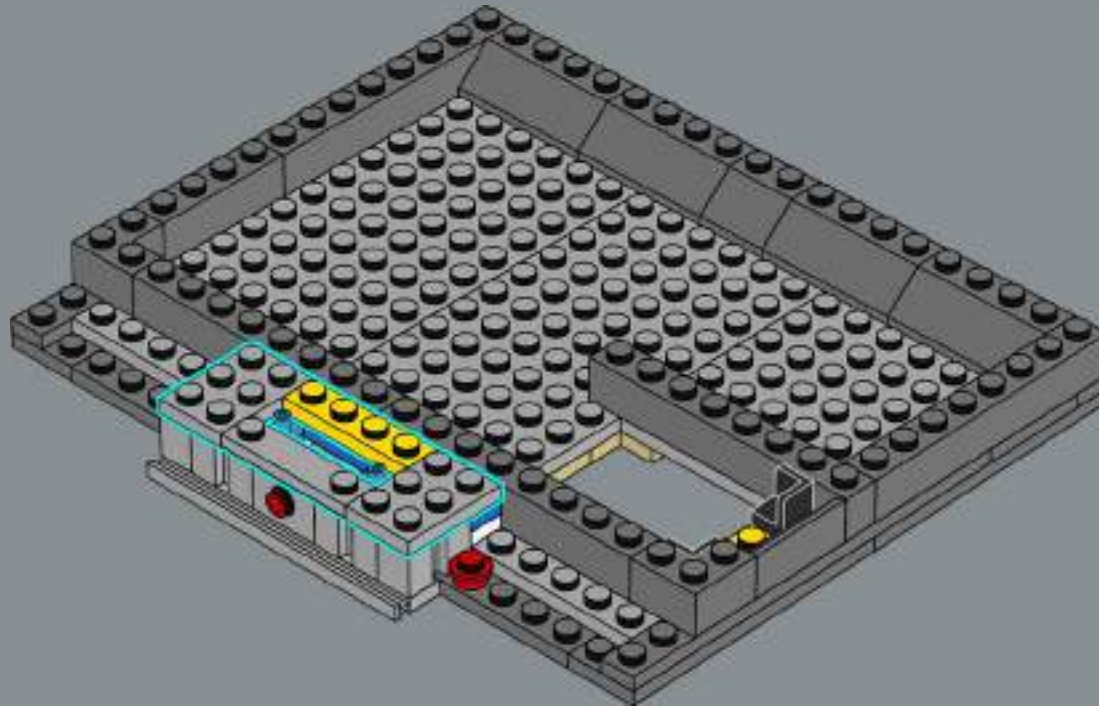

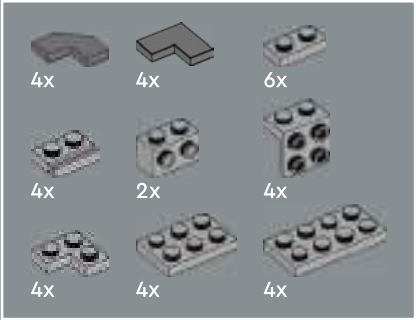
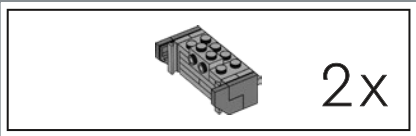

366

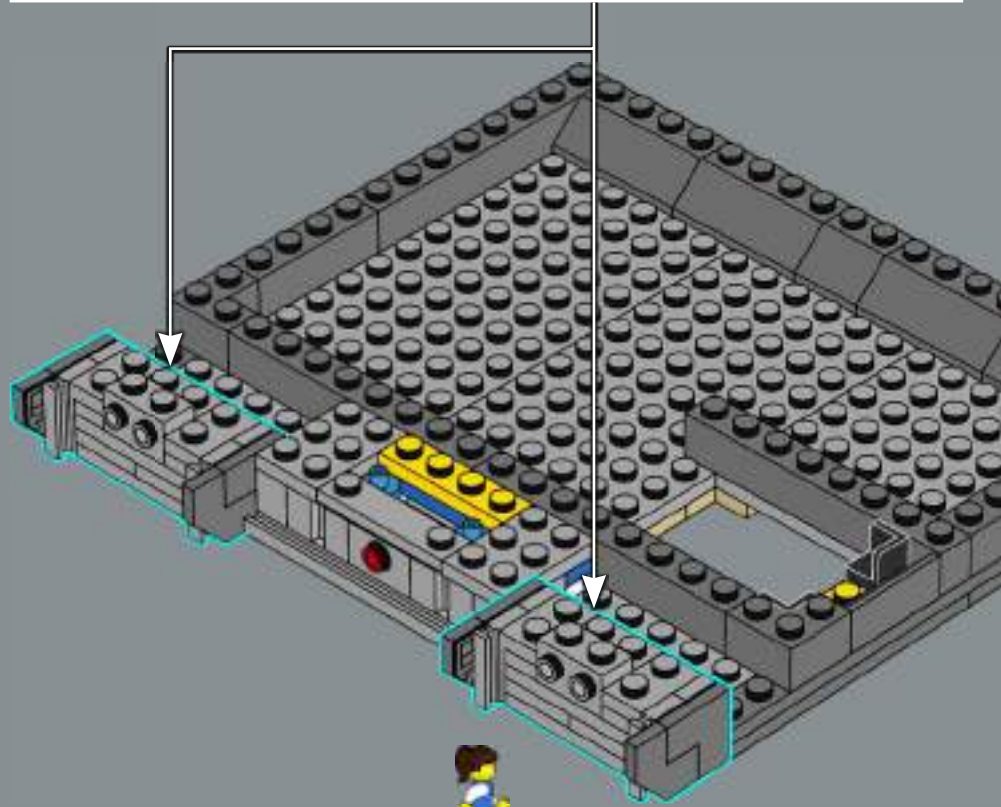
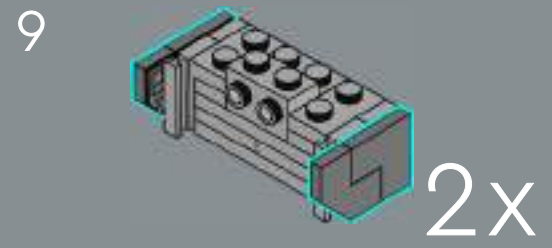
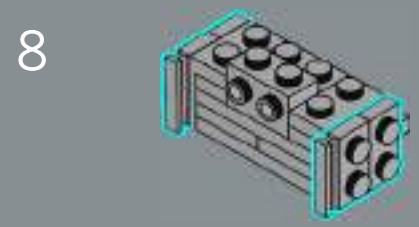
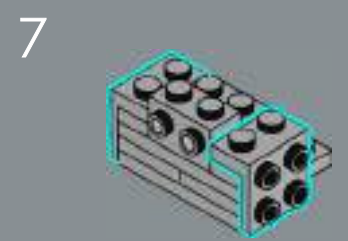
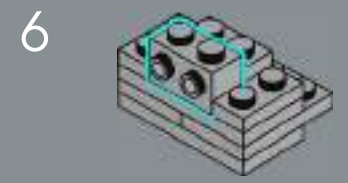
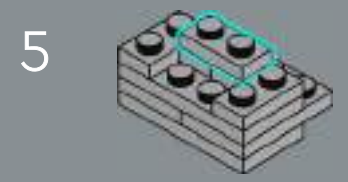
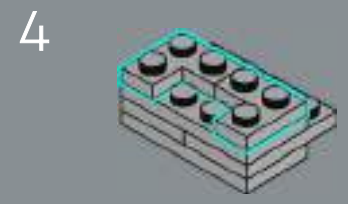
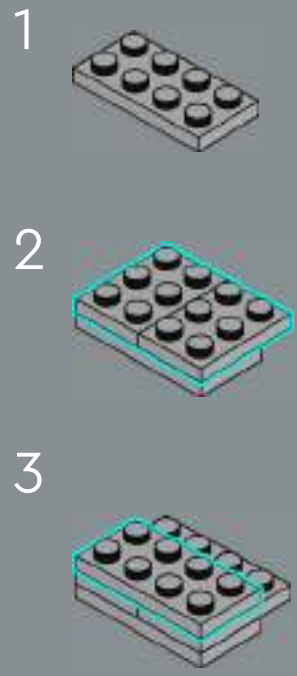

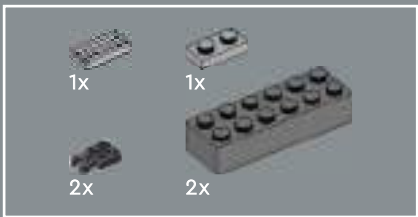

367

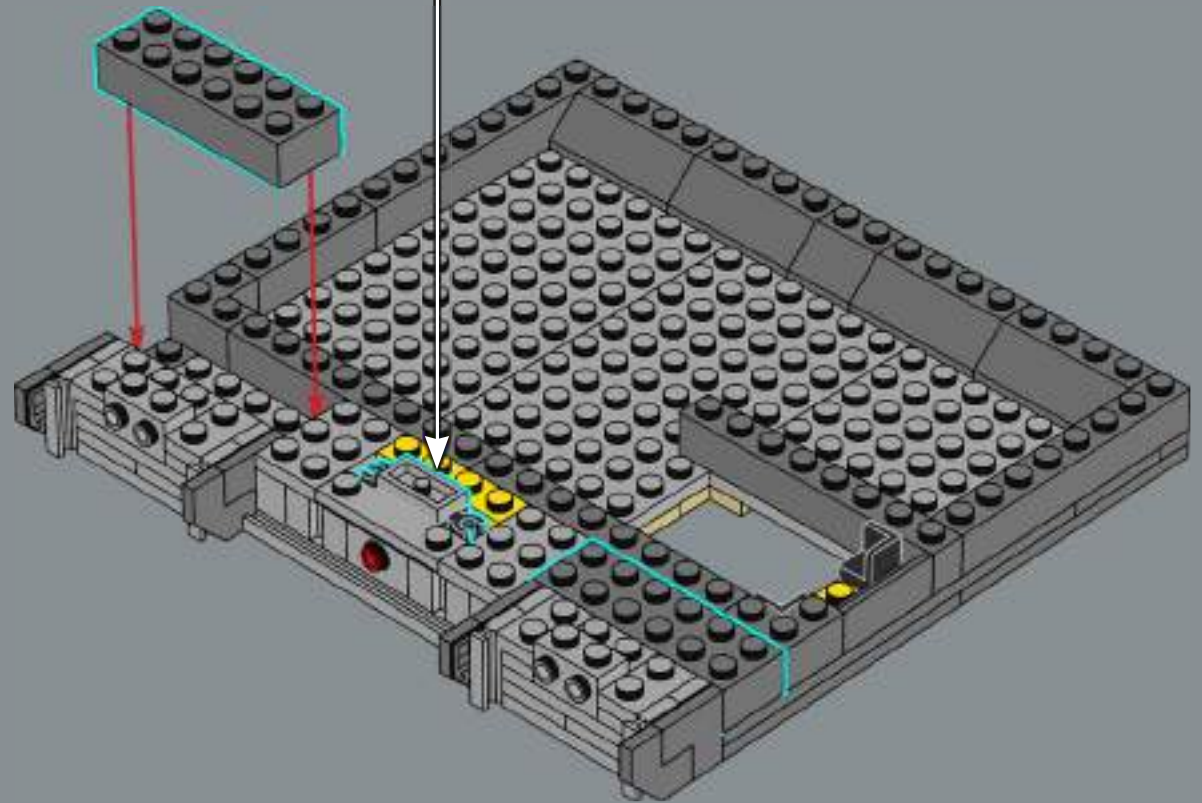



368

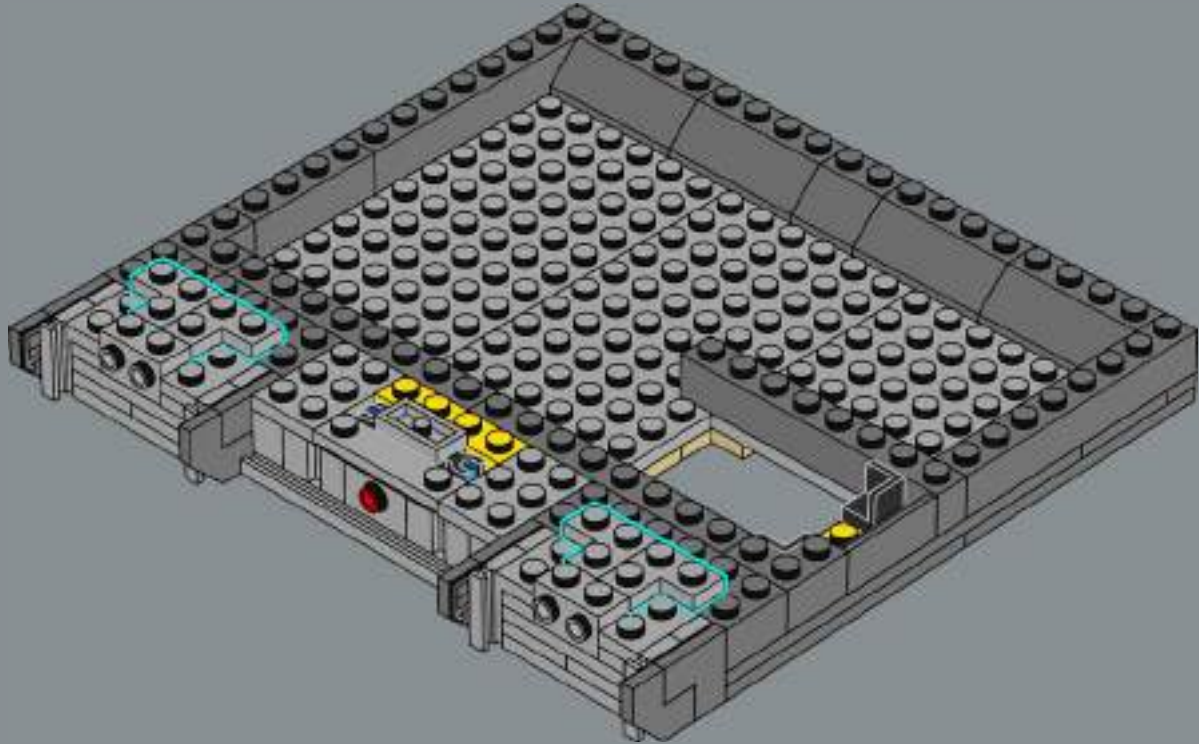



369

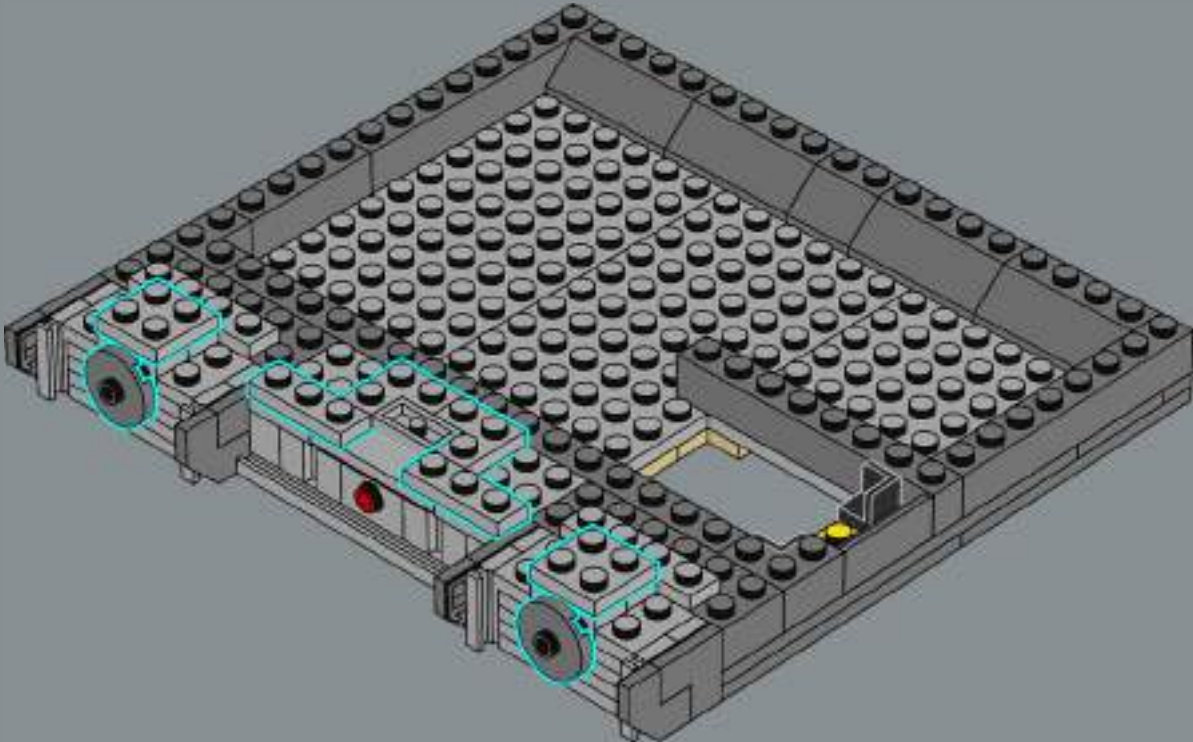



370

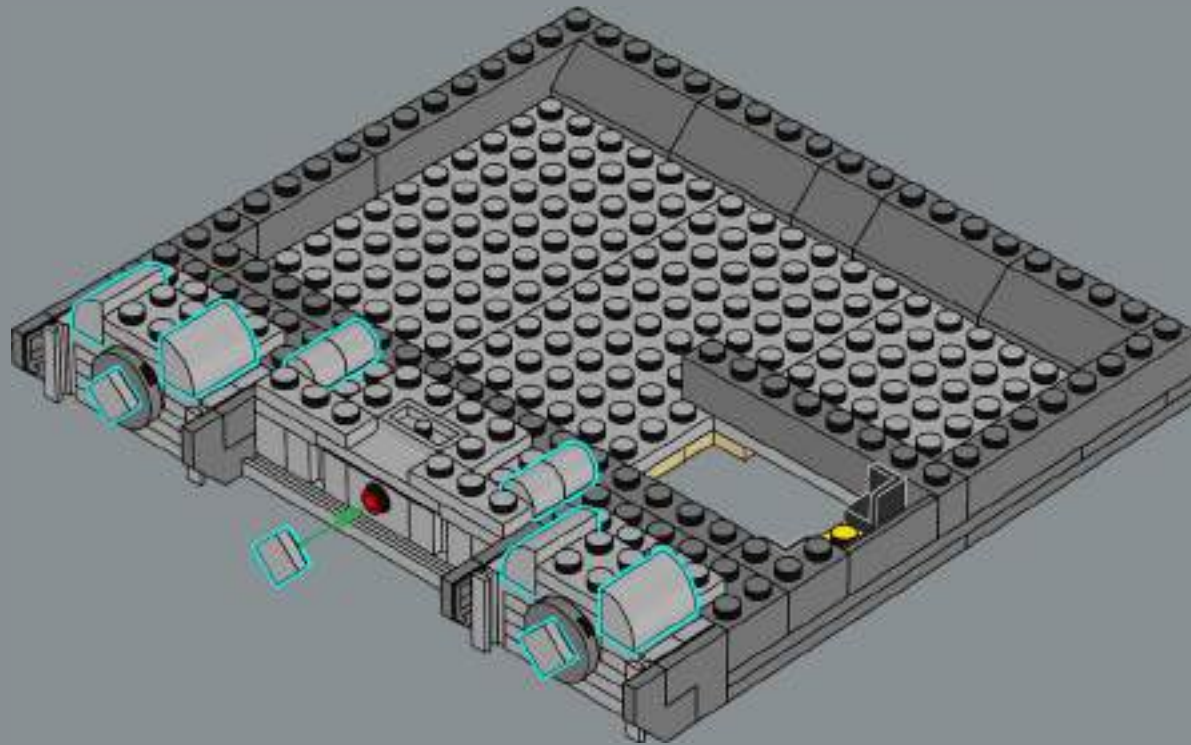



371

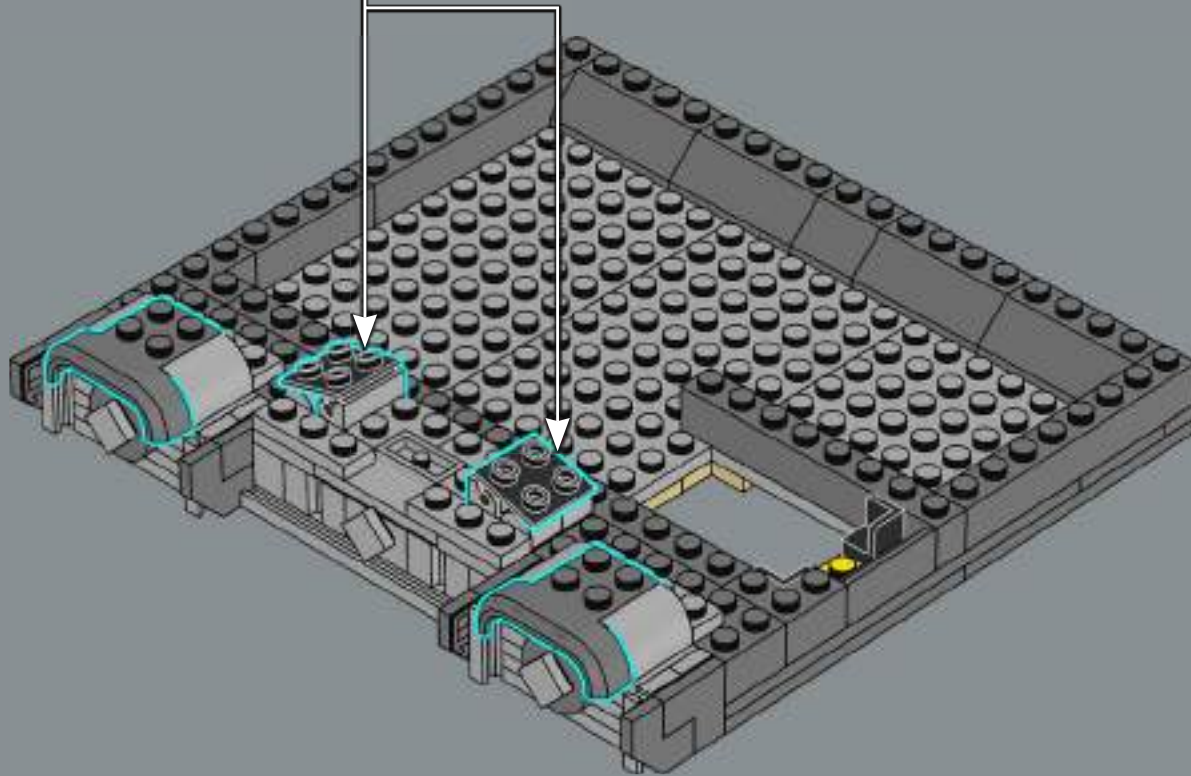
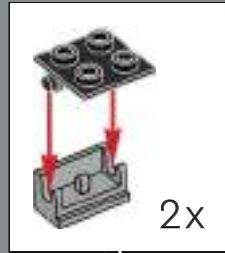



372

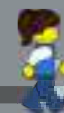
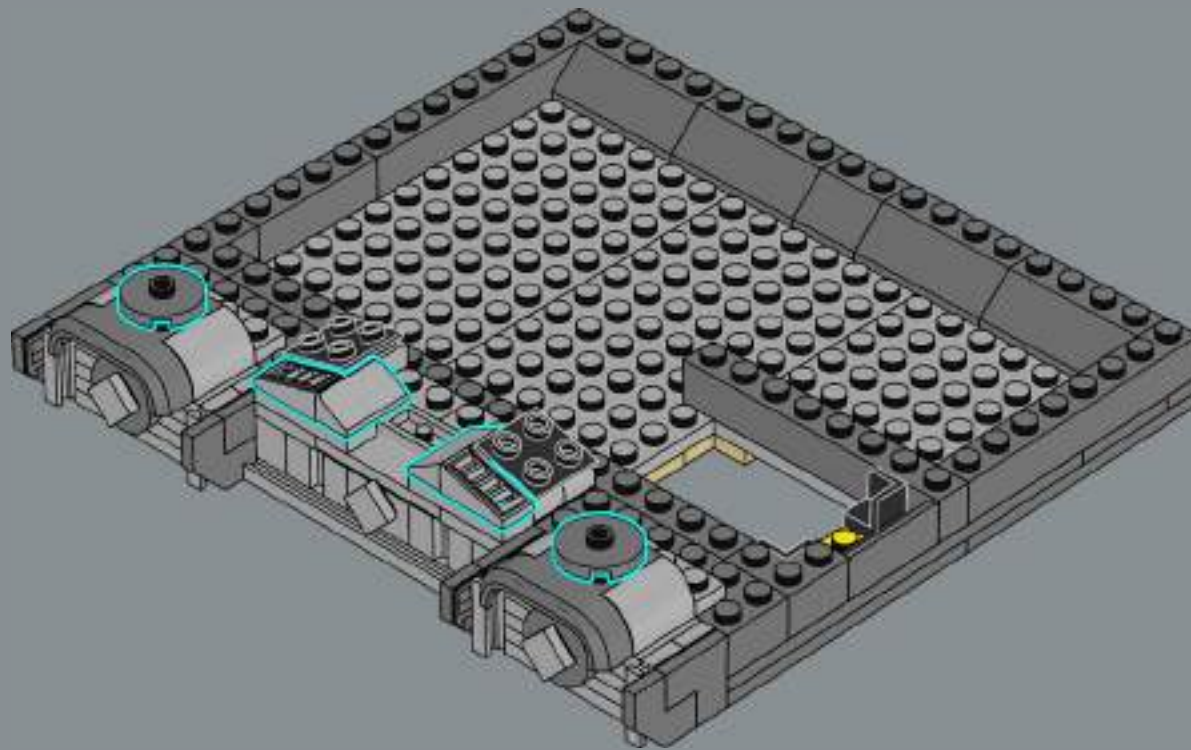

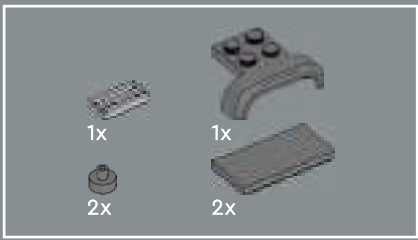

373

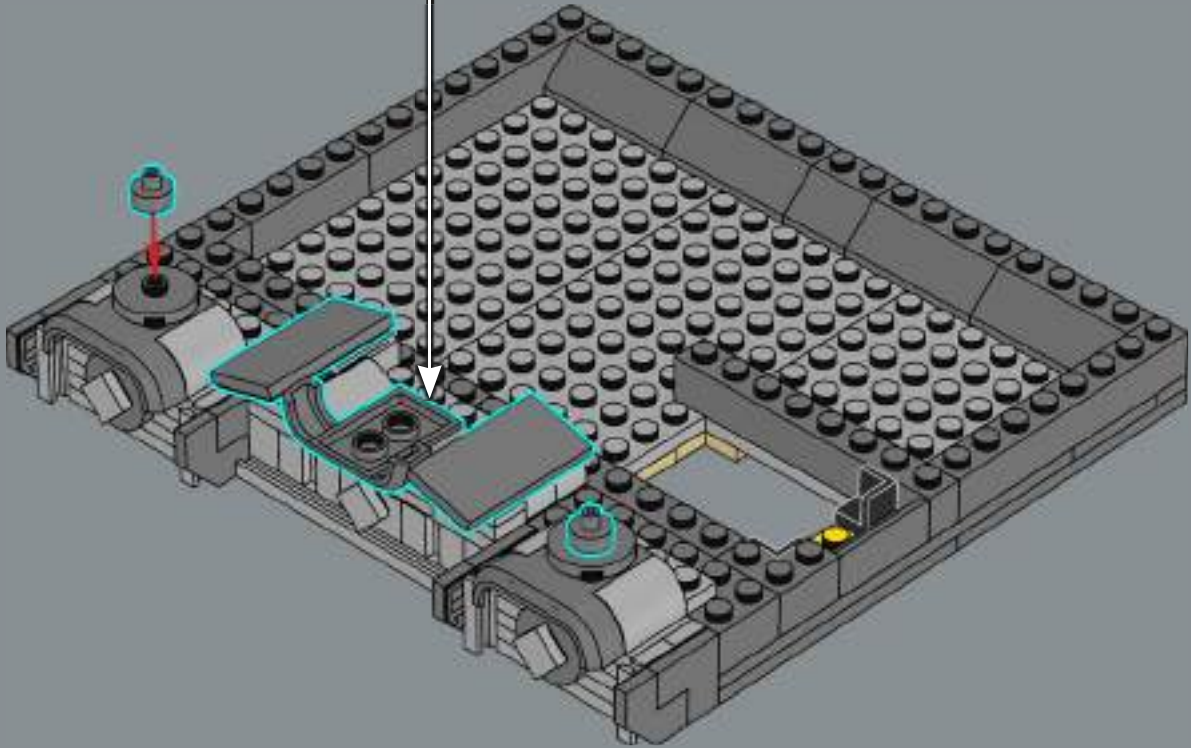
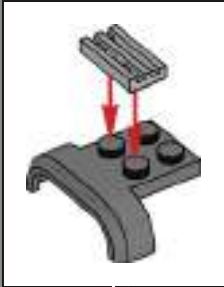



374

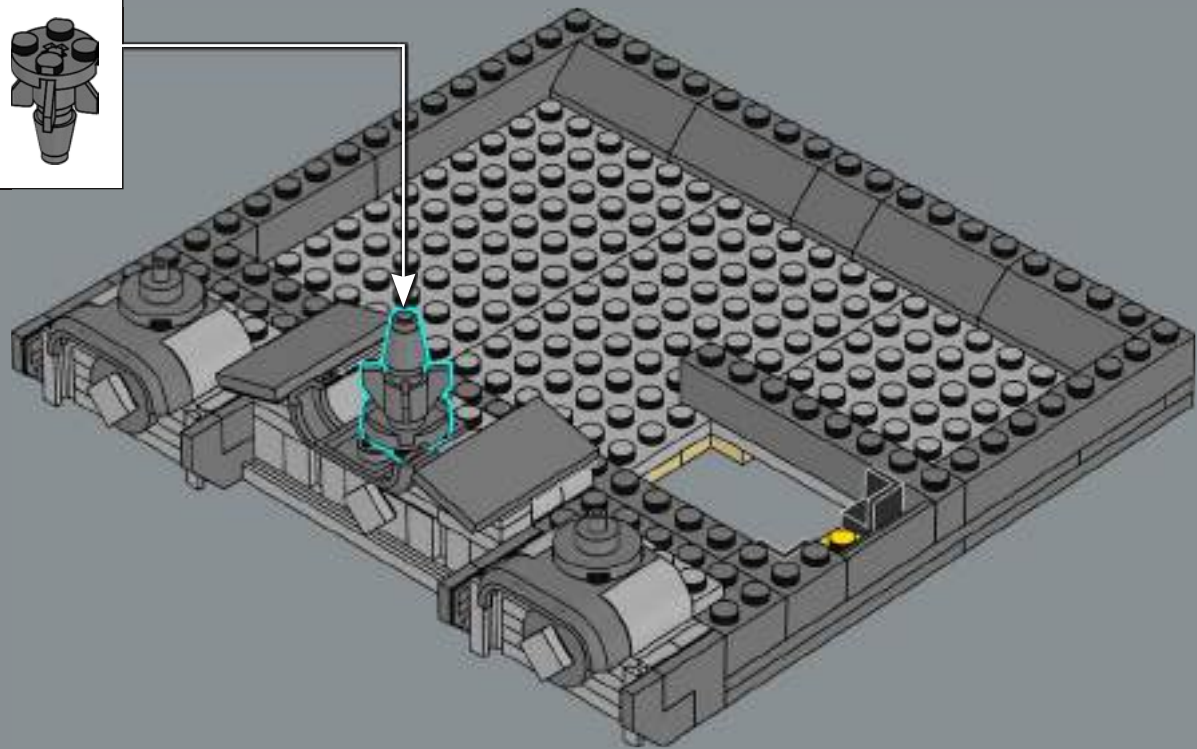
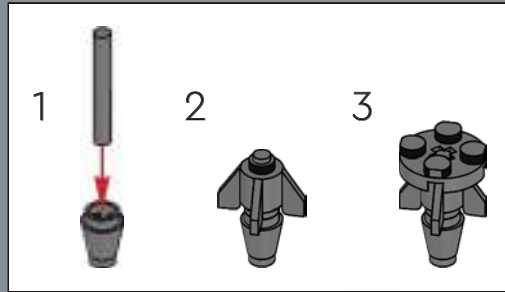

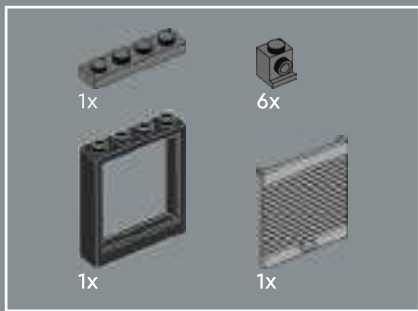

375

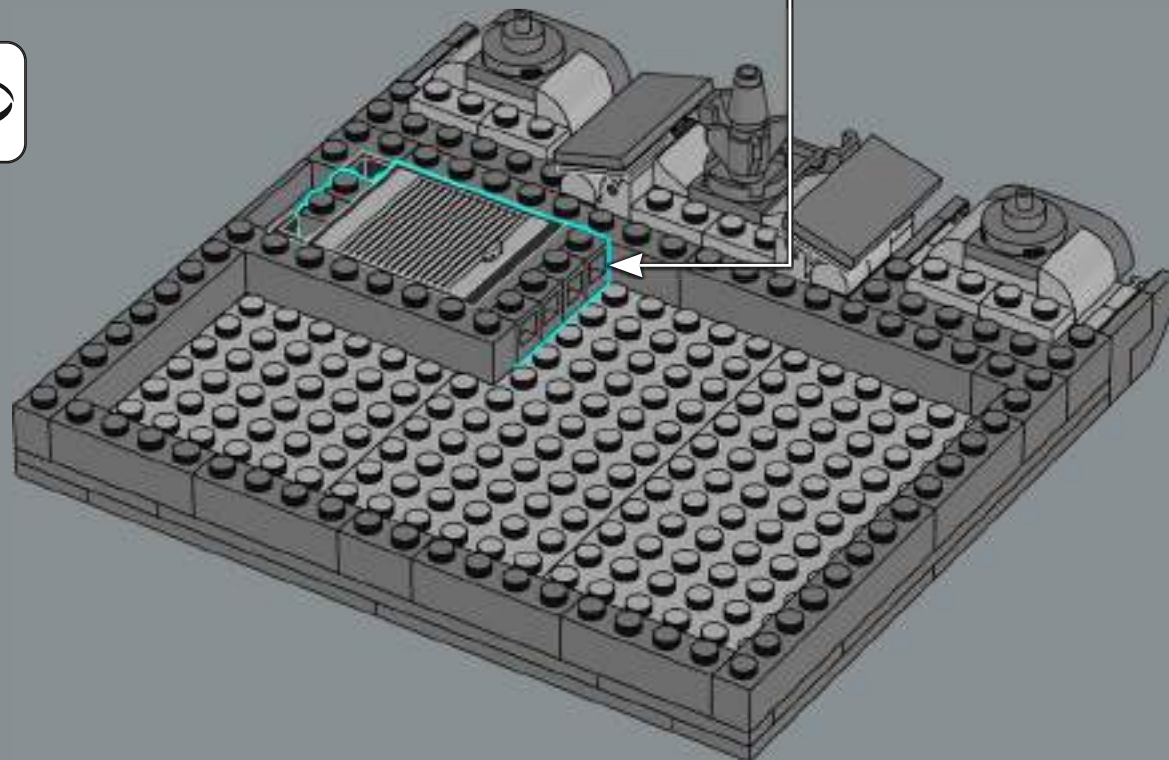
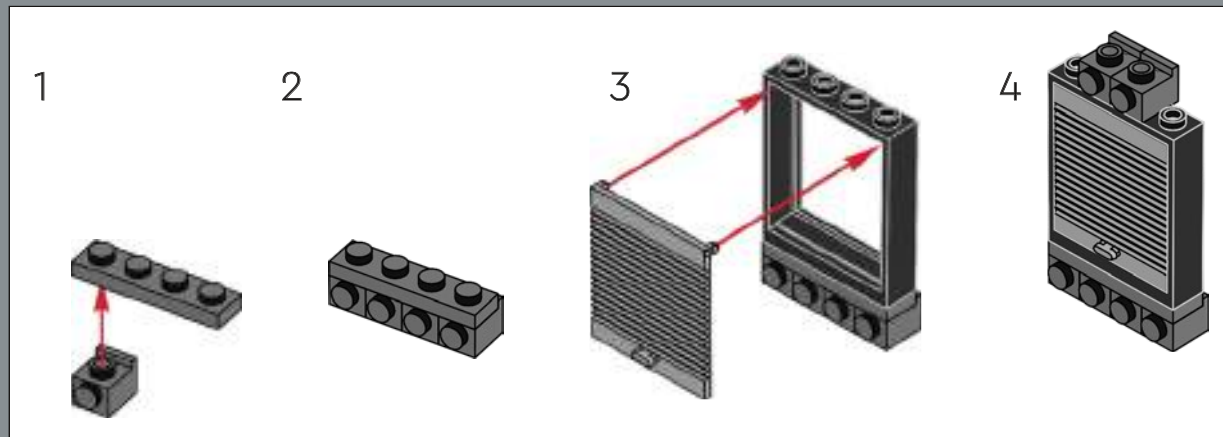



376

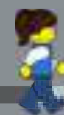
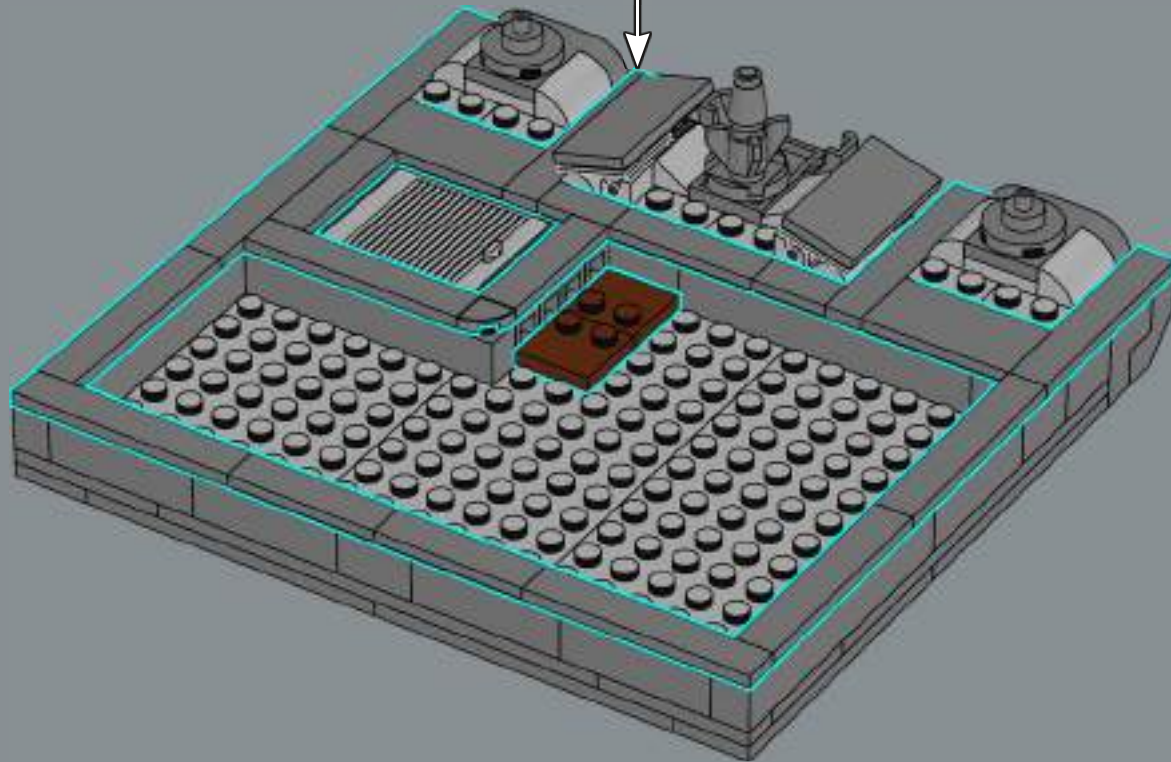
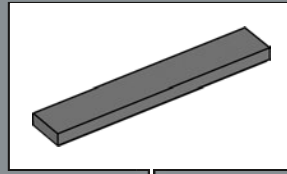



377

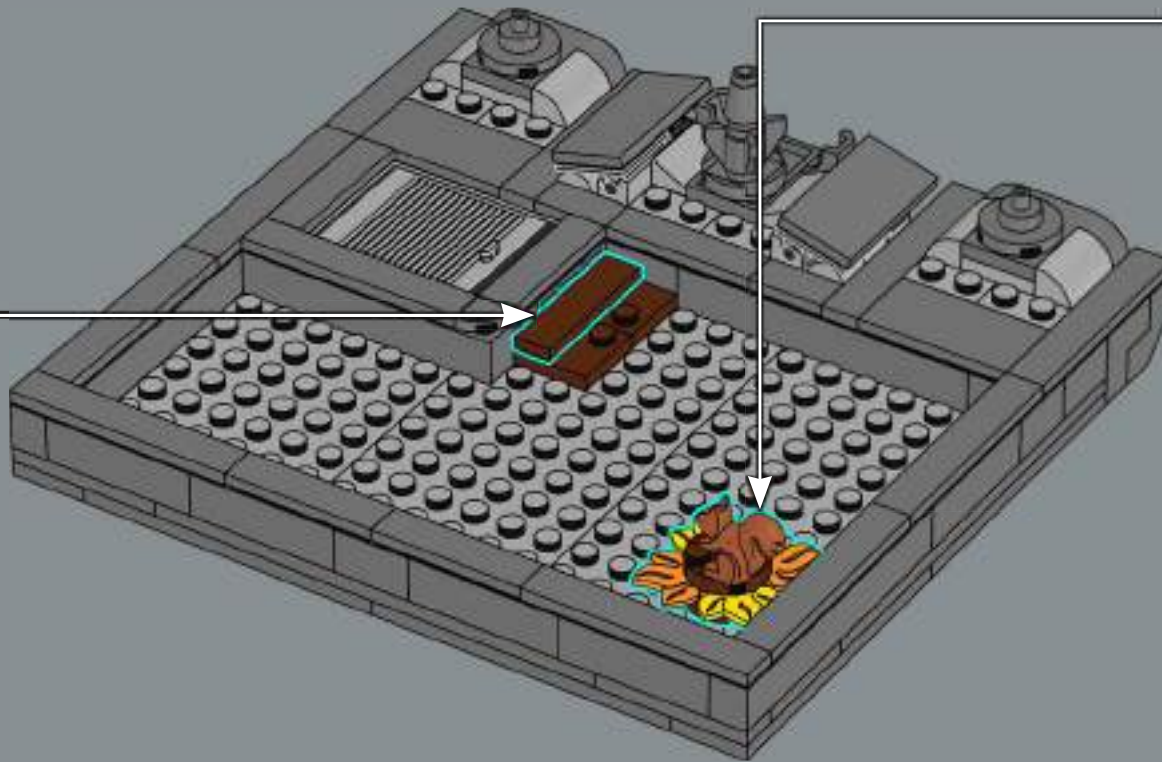



Watch out for the mischievous squirrel! If you stop for a slice of pizza, you might just find it disappears from your hands and ends up on the roof!

378





379

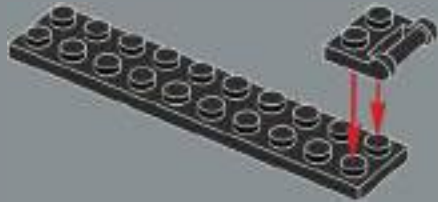

380

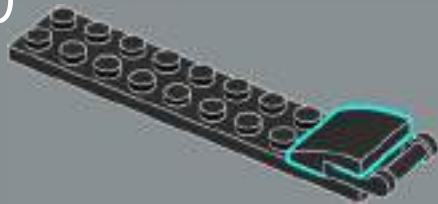

381

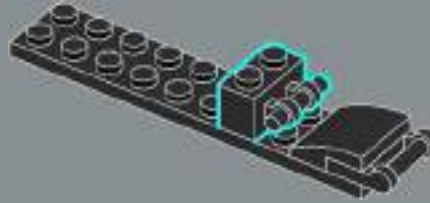

382

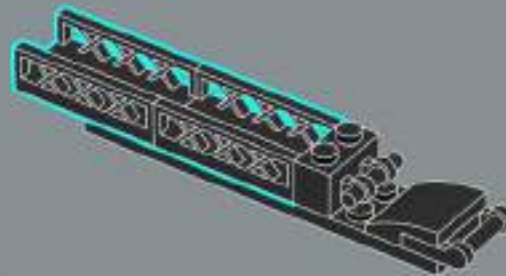

383

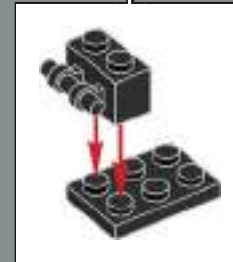
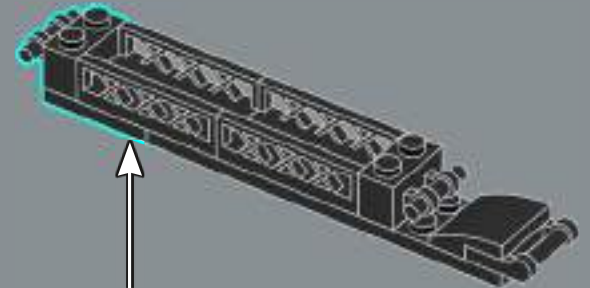

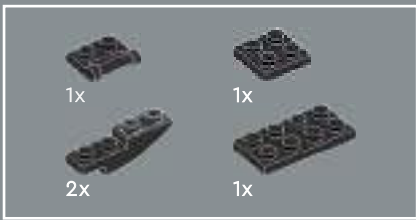

384

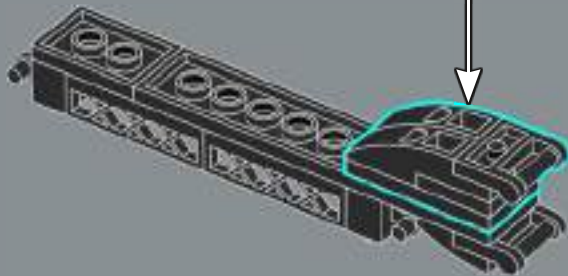
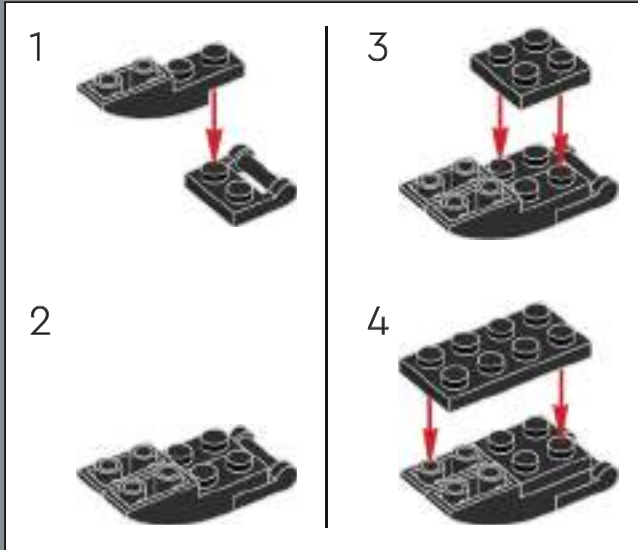

385

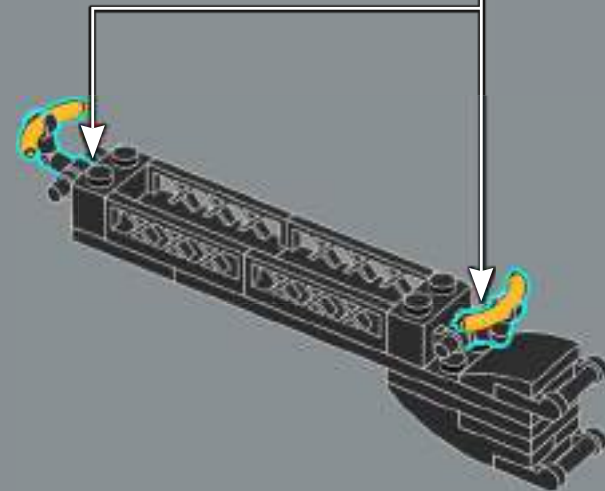

The LEGO® sausage has proven to be an incredibly useful element. It has appeared in 9 colours in dozens of LEGO sets.



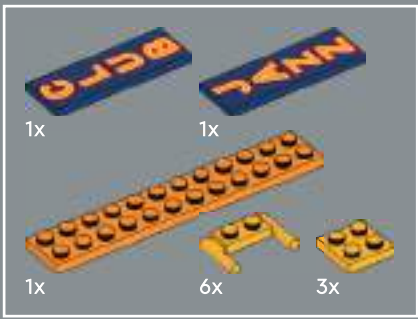

386

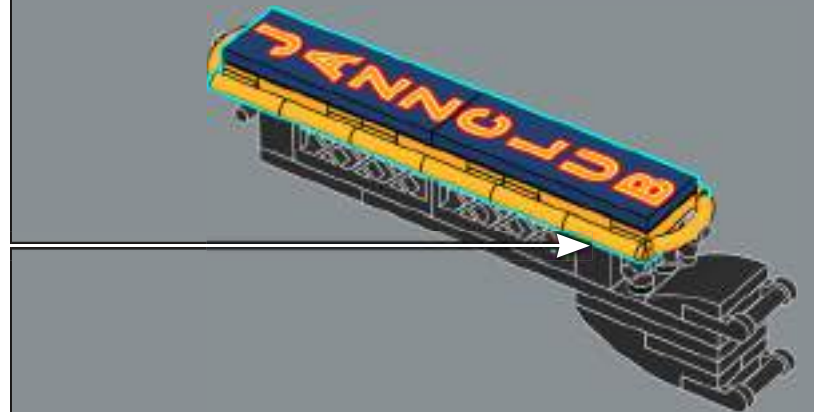
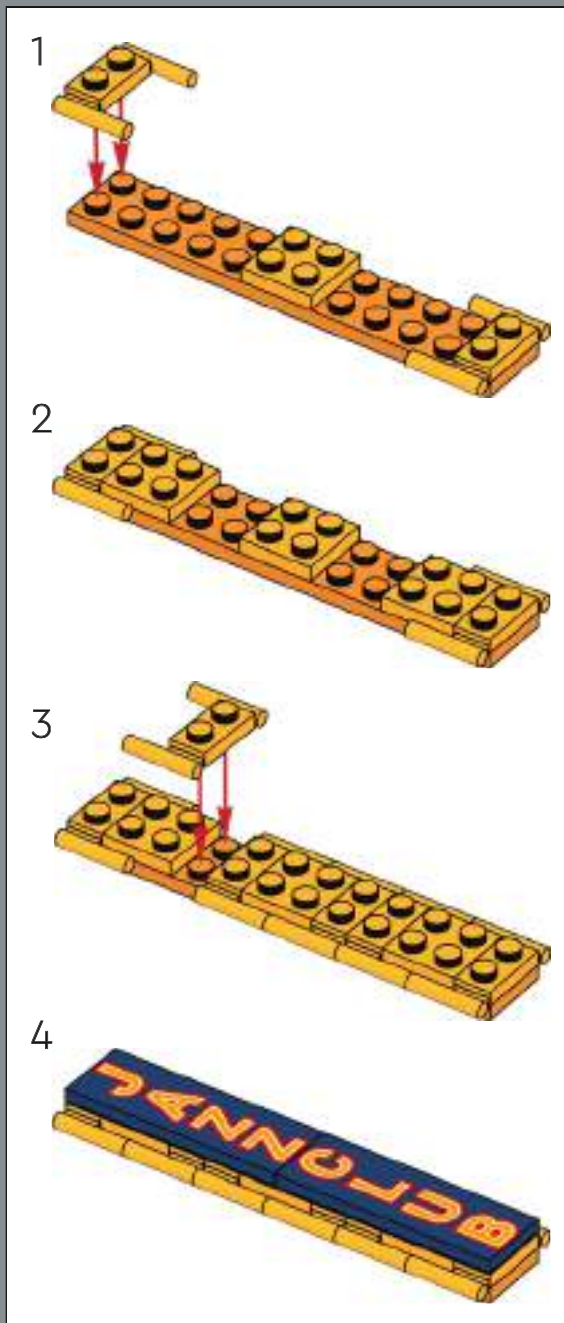

387



The delivery driver is happy to bring pizza anywhere around town. Don't be surprised if he's a bit late, though. He loves to listen to the Jazz Club's shows, and it can be hard to drag him away.



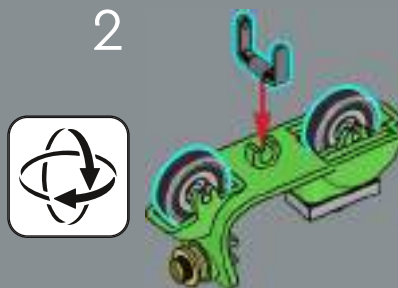
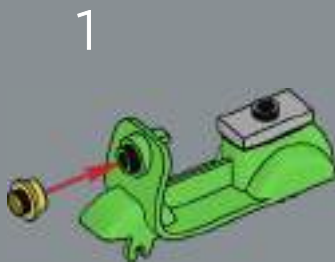
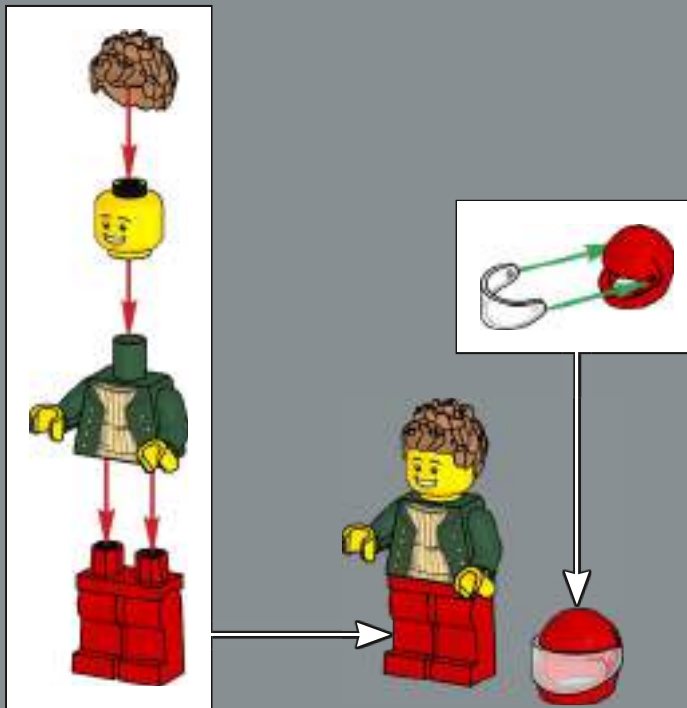

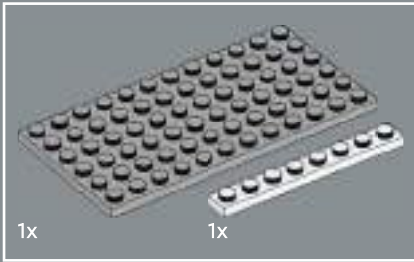

388

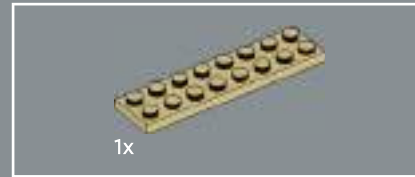

389

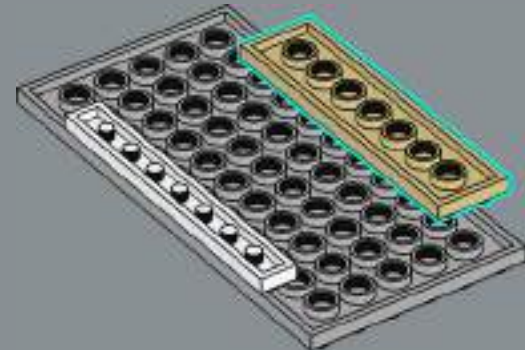

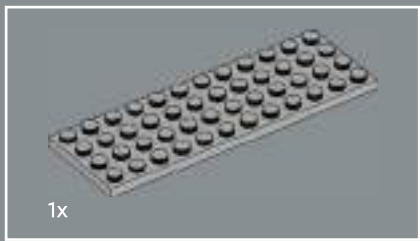

390

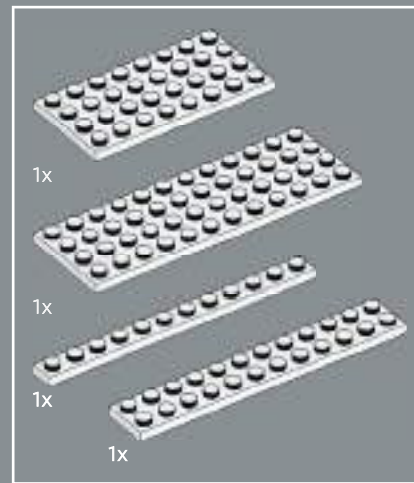
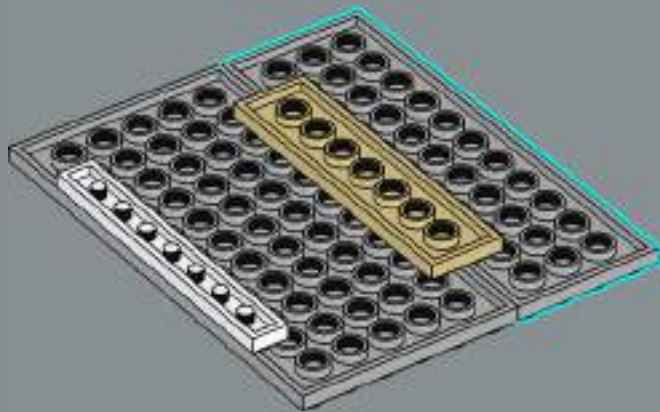

391

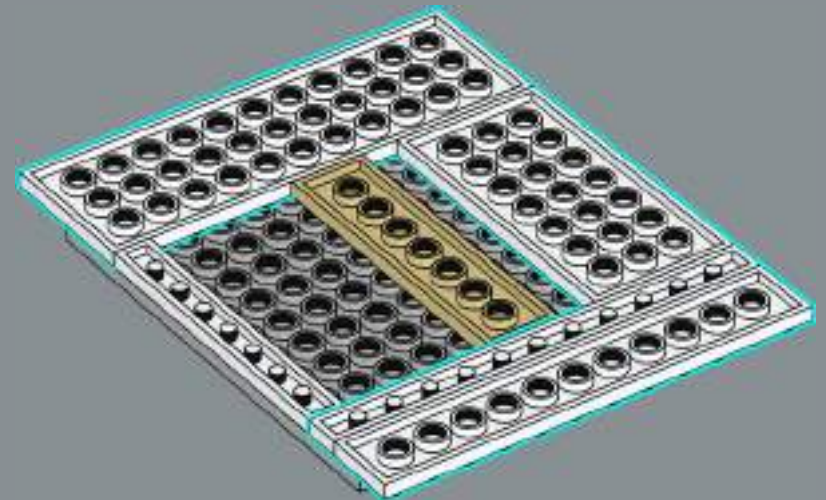

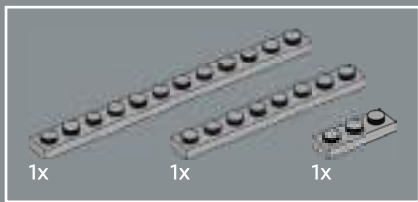

392

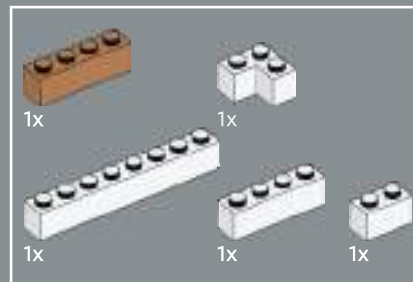
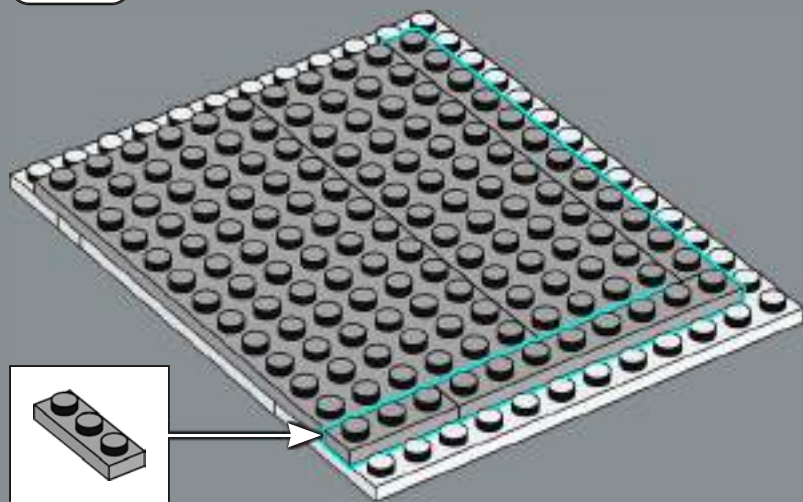

393

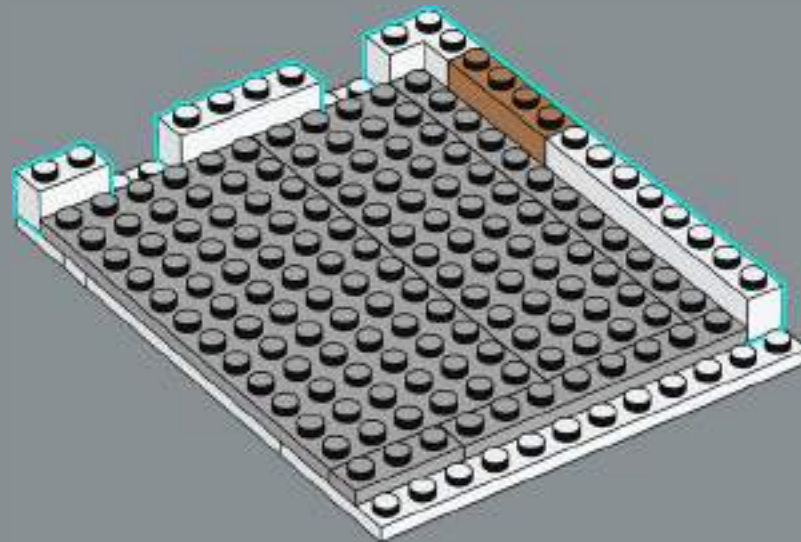



394

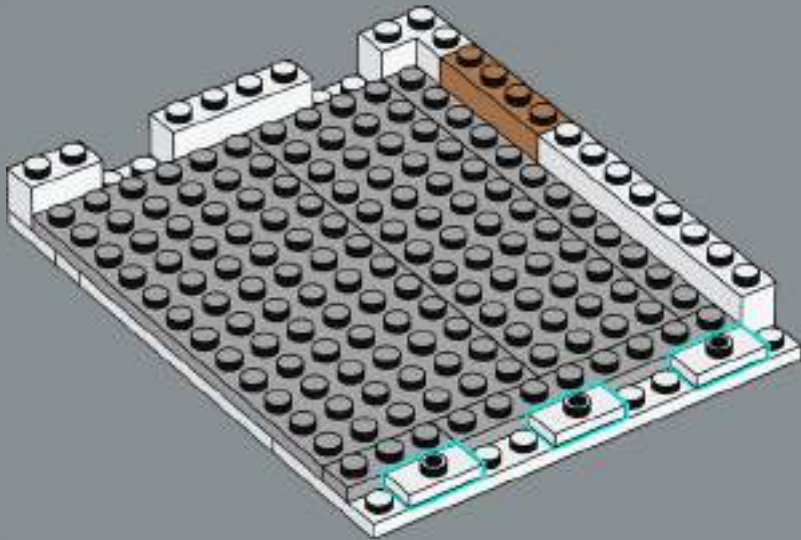

395

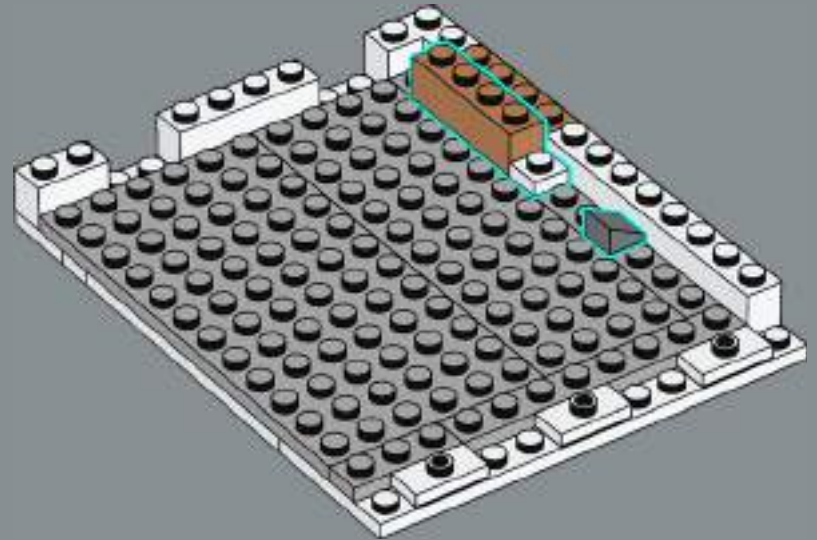



396

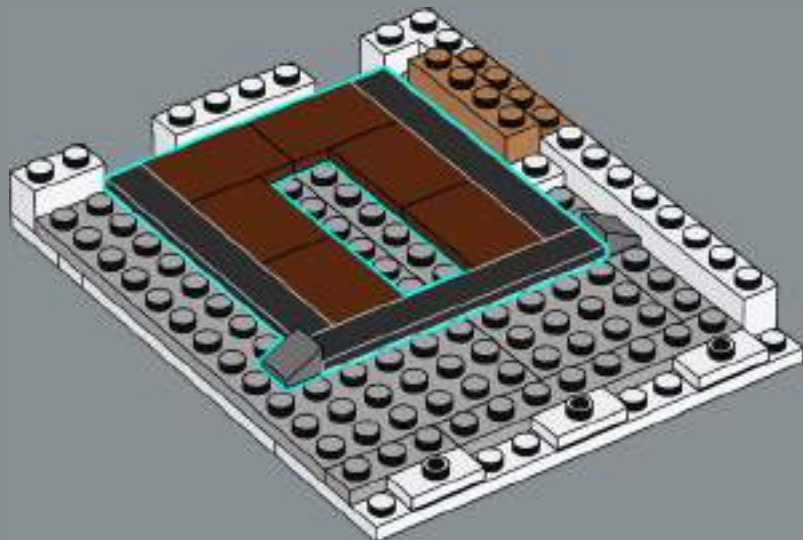

397

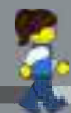
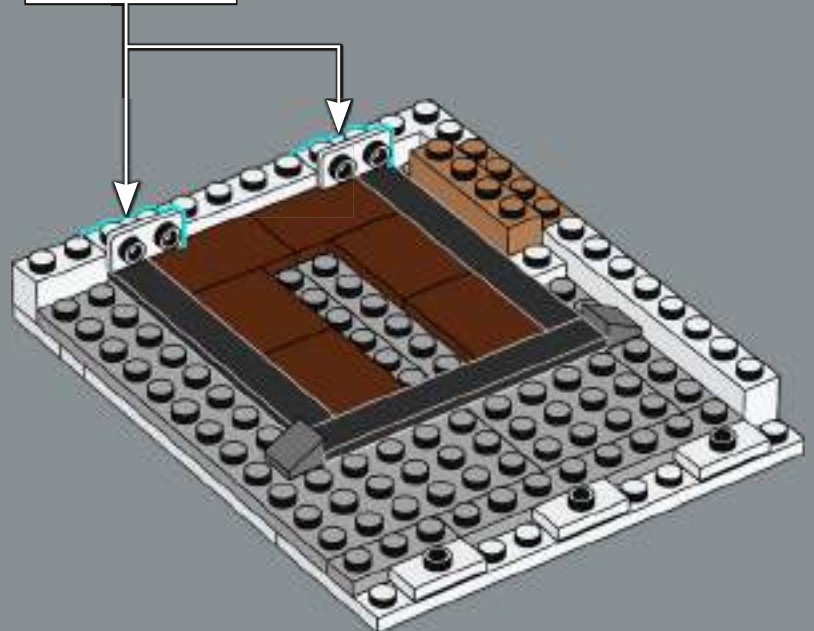
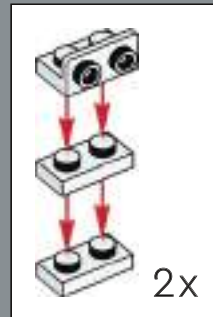



398

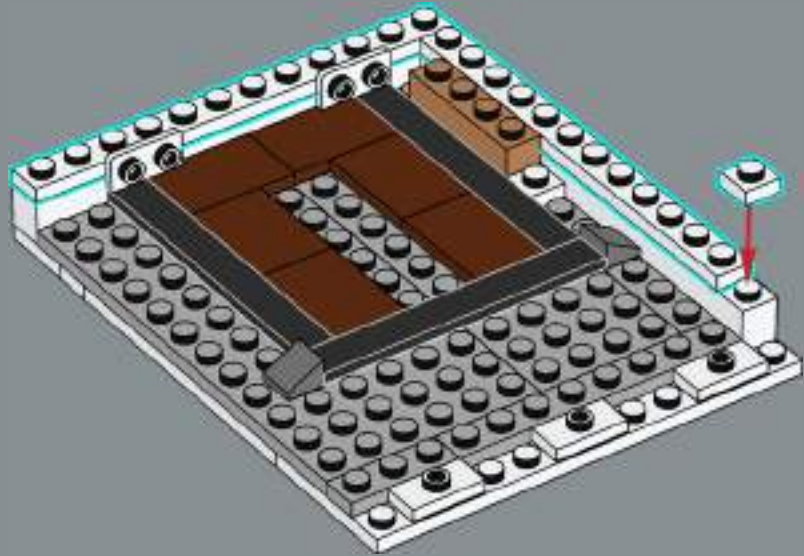

399

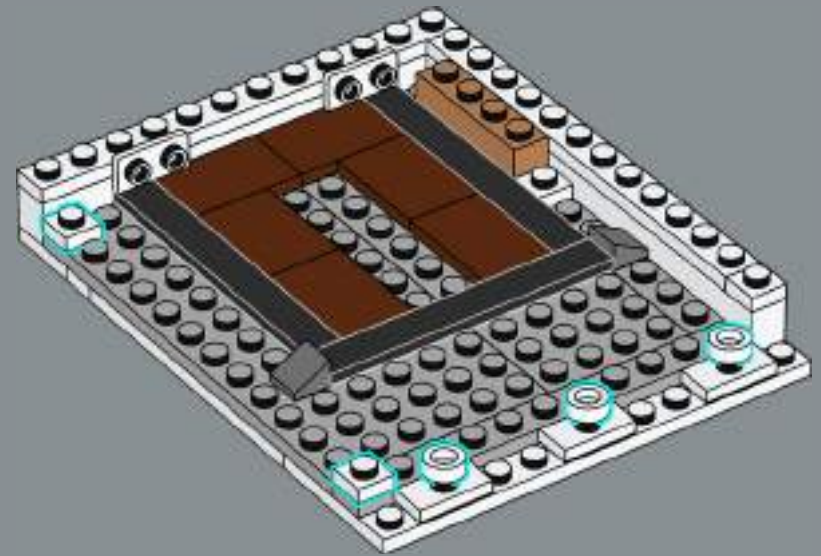



400

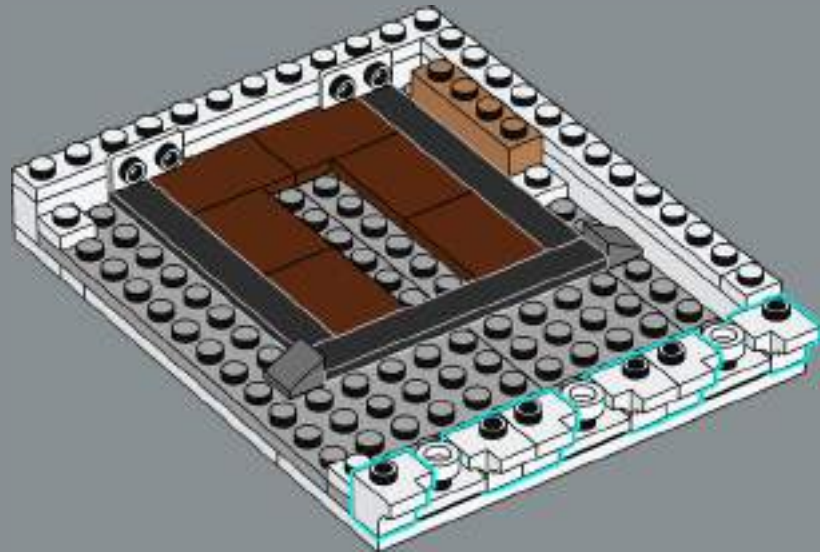

401

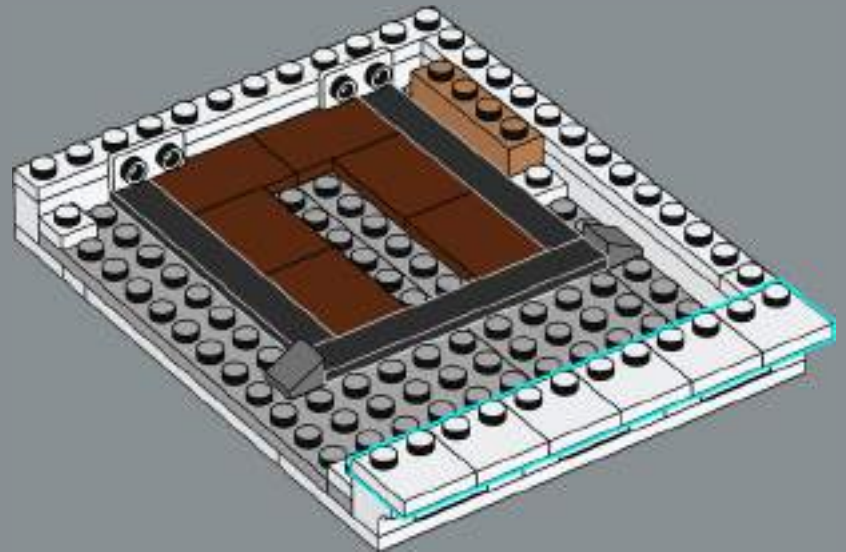

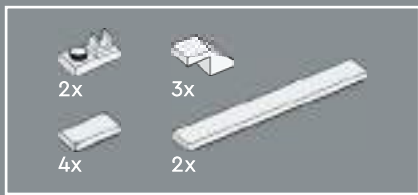

402

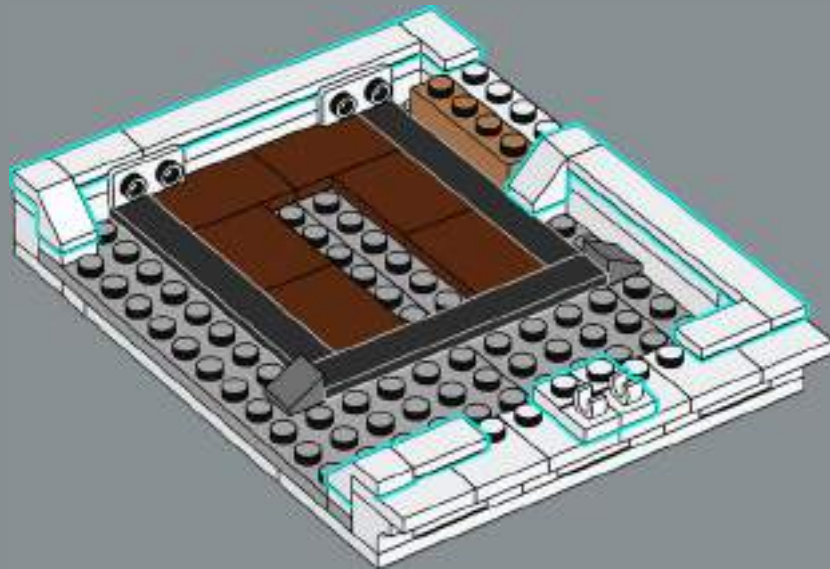

403

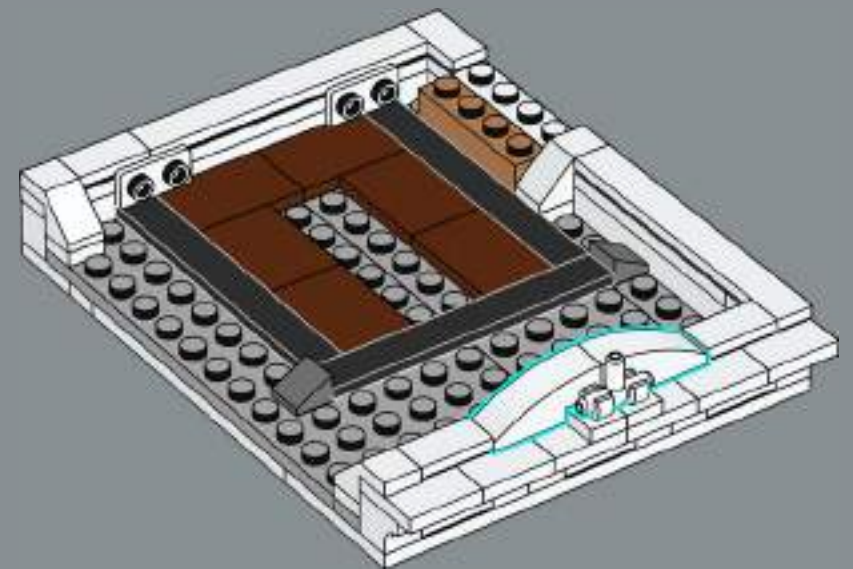

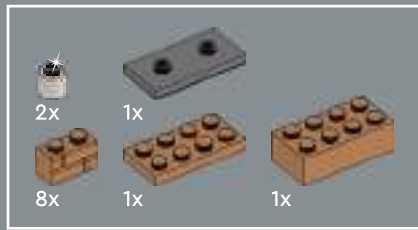

404

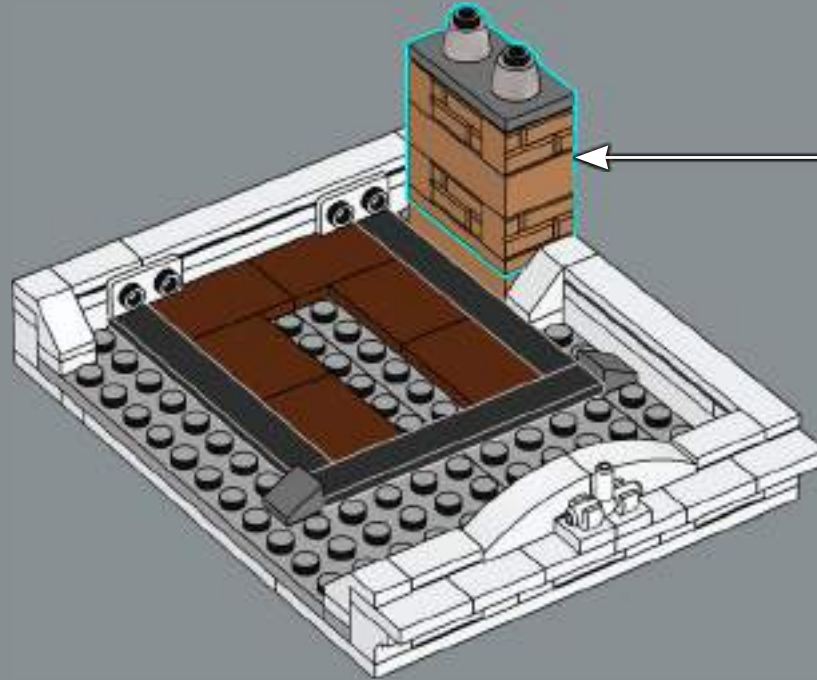
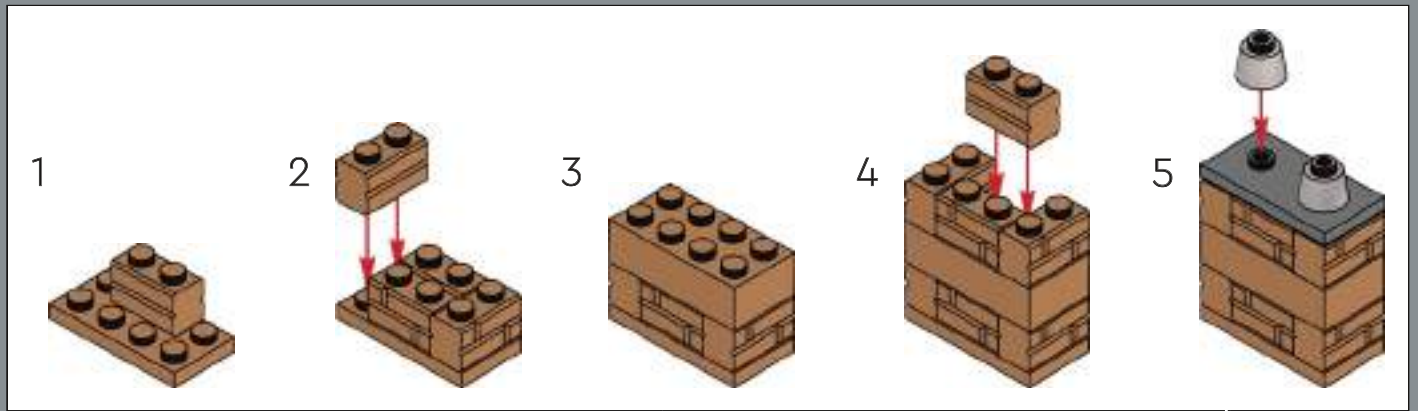

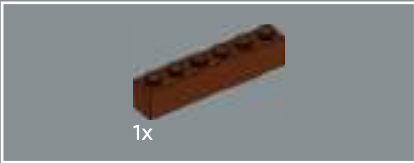

405



406

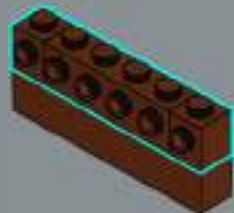

407

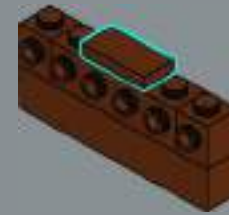

408

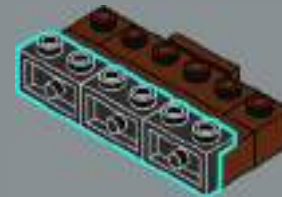



409

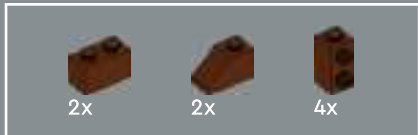
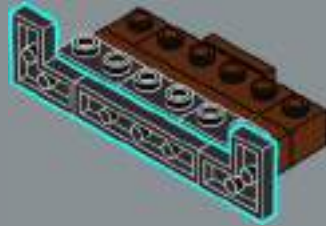

410

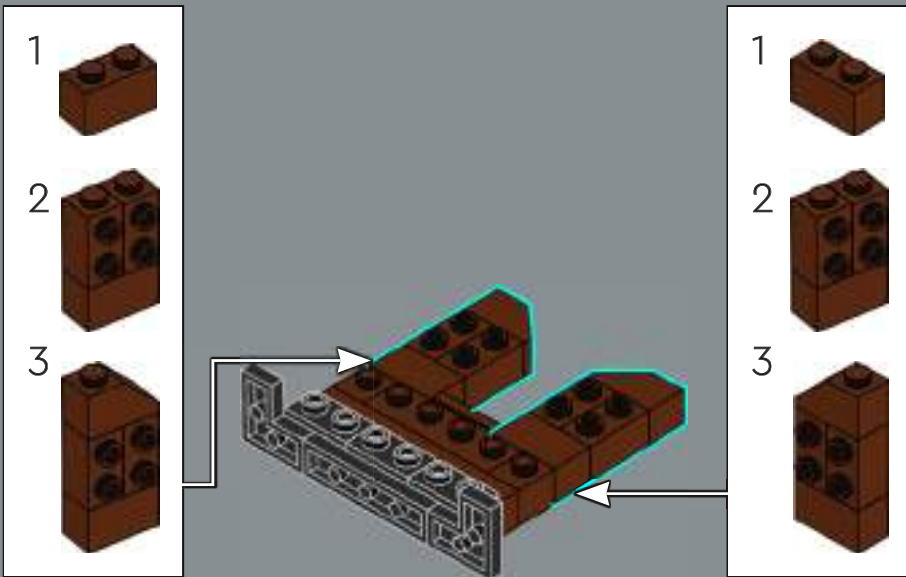

411

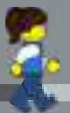
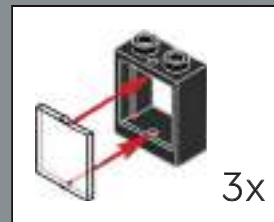
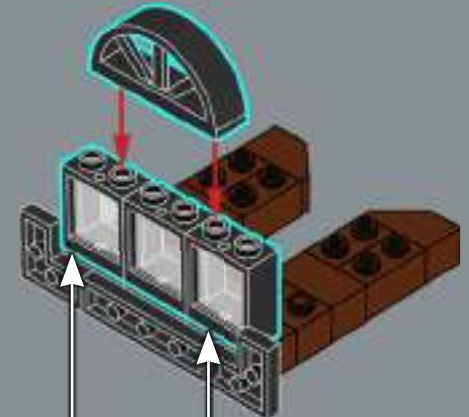



412

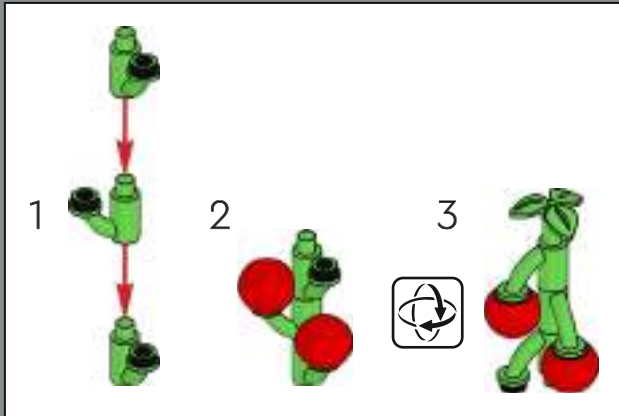

413



The pizza chef grows his own tomatoes and several herbs for his pizzas. The carrot, however, is reserved for the magician's rabbit.



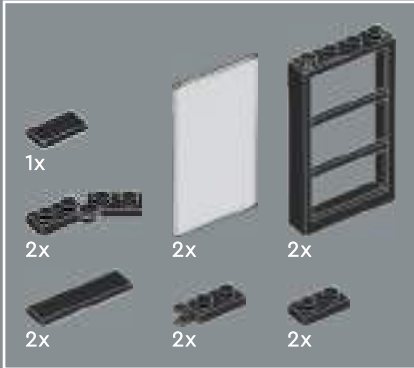
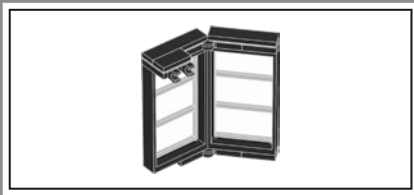

414

1

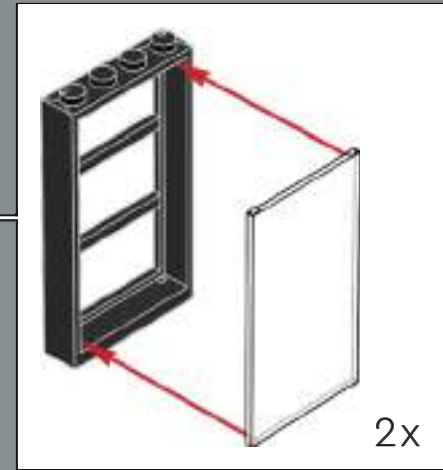

2

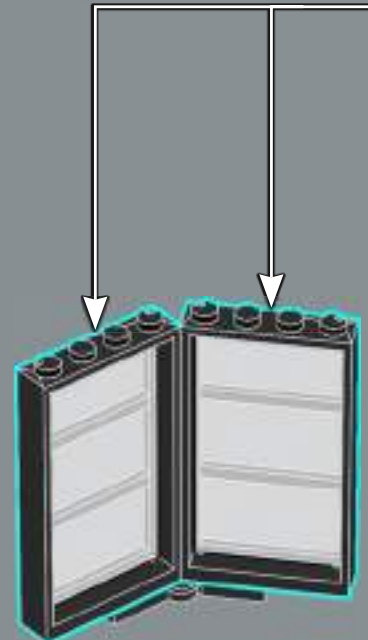

3

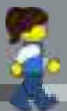

4

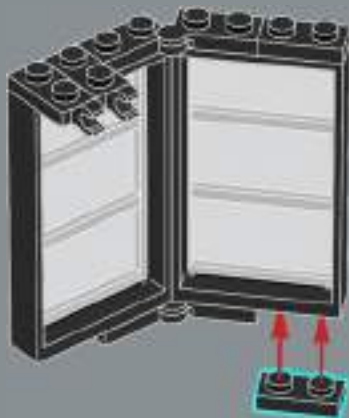

5

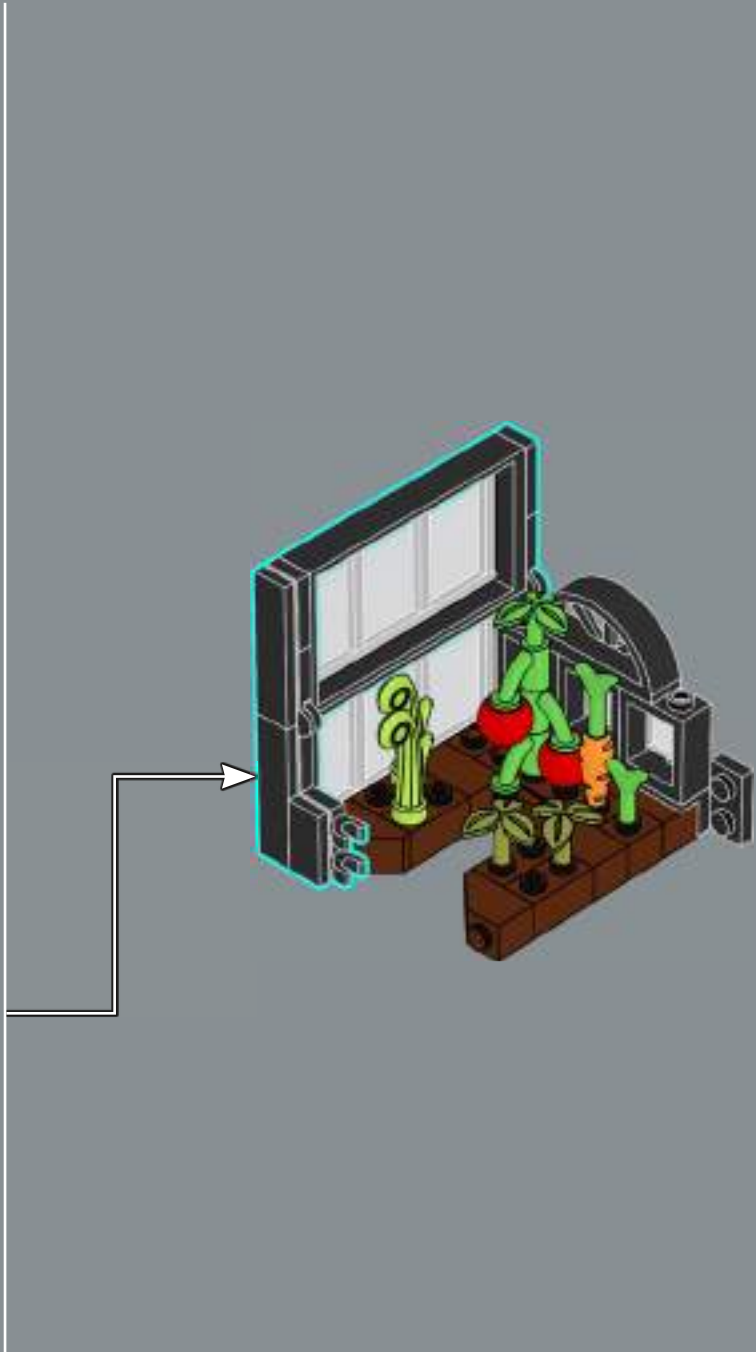

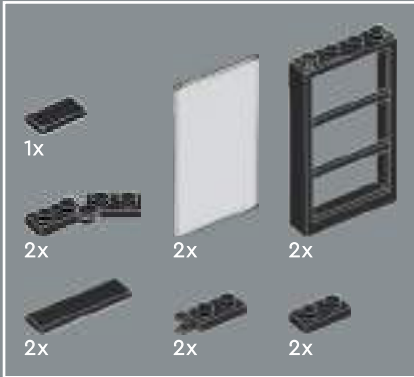
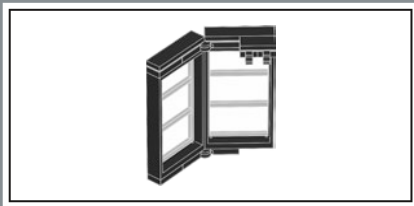

415

1



2

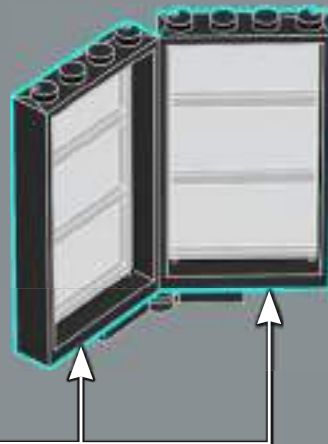
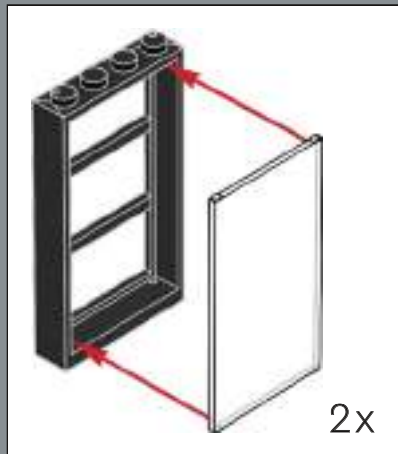

3

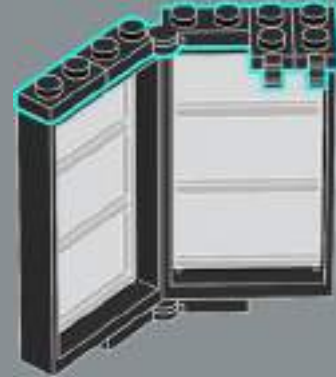

4

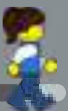
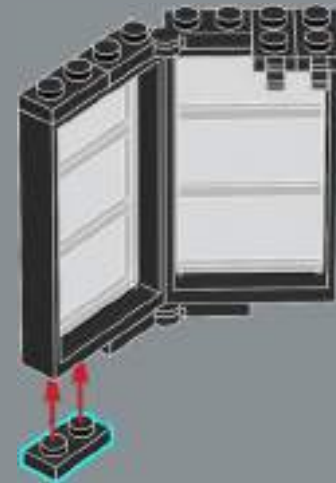

5

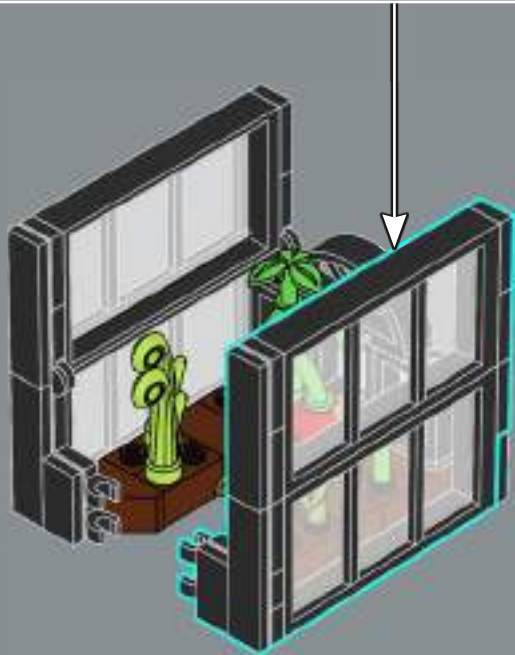
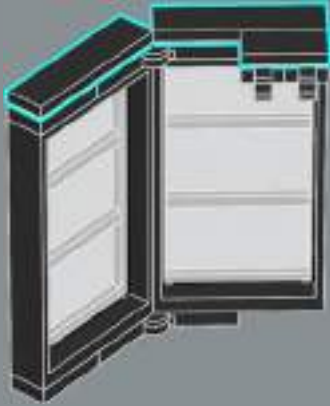

416



417



418



419

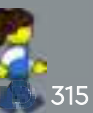



420







2x 300526	2x 6039869	12x 371026	1x 4514845	1x 474026	4x 6271169	1x 6431021	4x 6279875	1x 6206150
4x 4644456	9x 302426	13x 243126	13x 6186675	2x 6195325	4x 6271169	1x 6430624	1x 6173119	3x 6388070
2x 4558954	1x 307026	2x 302026	2x 6335388	2x 4106347	2x 459926	1x 6430843	2x 414580	1x 6235080
1x 473326	2x 241226	2x 6350415	4x 6196548	5x 6173105	1x 408326	1x 6430843	2x 4124096	10x 6182261
2x 6330197	19x 302326	4x 663626	2x 6330189	1x 6408578	1x 408326	1x 6356860	1x 368026	1x 6331087
2x 4253815	10x 306926	3x 366626	4x 6157554	1x 6408578	1x 6066113	1x 6343688	4x 6416444	3x 4119479
2x 4288212	6x 6092585	1x 4243819	3x 6313116	19x 6382697	4x 4187209	1x 4105175	2x 4517986	1x 6430413
8x 4529236	2x 6214807	3x 416226	2x 6000650	1x 6408578	1x 6066113	2x 6326681	1x 6104209	13x 6254484
1x 4558957	4x 6166859	3x 416226	5x 6020193	8x 4536522	1x 602026	2x 4538456	1x 306228	11x 6253417
2x 6312449	7x 242026	2x 346026	1x 6310268	6x 4530589	1x 6151289	1x 6151289	1x 6047426	1x 6212081
1x 329826	3x 302226	2x 346026	6x 6336989	1x 6177083	1x 6170808	1x 6057397	2x 6347288	14x 6263221
1x 4529155	2x 6192346	1x 395826	3x 4225201	6x 6177083	1x 6057397	1x 6396403	1x 6229130	43x 6223040
4x 329726	7x 306826	1x 303526	4x 6168646	1x 6254519	2x 4623113	1x 6269971	1x 6269971	18x 6000743
1x 6275732	10x 6133722	3x 383226	3x 614126	4x 6116604	1x 6093525	1x 6106280	1x 6382575	1x 6361813
1x 6053077	2x 362326	3x 383226	6x 6210270	1x 9339	4x 6116604	13x 6315887	2x 6285598	8x 6186012
	4x 4558170		9x 403226			9x 6278152	1x 6314378	
	3x 302126		1x 6431014					

- 3x 4570877
- 2x 4614158
- 2x 6092602
- 2x 6315197
- 4x 6248949
- 1x 6313129
- 1x J5 6172566
- 1x 6384077
- 2x 6220959
- 1x 6251294
- 16x 6252258
- 21x 6254552
- 4x 6256058
- 6x 6253734
- 32
- 1x 6171728
- 1x 6247362
- 1x 6168665
- 1x 6244787
- 2x 6166107
- 1x 6247369
- 1x 6337596
- 4x 6240551
- 8x 6252043
- 1x 6274739
- 1x 6283590
- 4x 6277483
- 2x 6253884
- 2x 6238674
- 8x 6252045
- 6x 6274740
- 19x 6240216
- 1x 6171728
- 1x 4267425
- 2x 6213782
- 3x 6213779
- 1x 6210775
- 2x 6240467
- 8x 6240553
- 3x 6174006
- 2x 6188696
- 1x 6306726
- 1x 4558595
- 2x 6253884
- 1x 6103249
- 1x 6240515
- 1x 6313826
- 1x 6001822
- 1x 6273590
- 9x 6055172
- 4x 4496699
- 1x 6092591
- 5x 4507045
- 2x 6396392
- 17x 6175927
- 1x 6270031
- 1x 6031821
- 2x 6216905
- 1x 6422001
- 1x 6422002
- 2x 6350417
- 1x 6310830
- 2x 4162916
- 103x 6052777
- 10x 4541528
- 4x 6089268
- 2x 6311108
- 24x 4539092
- 1x 4539099
- 2x 6267414
- 2x 6173168
- 2x 6042953
- 24x 4539114
- 2x 4539090
- 61x 4539097
- 10x 4585751
- 2x 4585479
- 2x 4162916
- 70x 4539102
- 31x 4541379
- 18x 6264025
- 2x 4539105
- 4x 4539076
- 2x 4583299
- 2x 4539062
- 3x 4541507
- 2x 6253142
- 4x 6384234
- 2x 6359683
- 2x 6313126
- 17x 6335330
- 6x 6359716
- 3x 6003033
- 8x 6020073
- 2x 6422005
- 6x 6331205
- 1x 6209681
- 1x 6212994
- 2x 6430410
- 2x 6245265
- 4x 6061685
- 2x 6186542
- 4x 6073040
- 4x 6099714
- 4x 6020923
- 1x 6409778
- 1x 6349342
- 2x 4211199
- 4x 6146858
- 1x 4658005
- 24x 4211288
- 3x 4221744
- 2x 4211150
- 2x 4224243
- 4x 4211151
- 4x 4216695
- 4x 6196221
- 1x 6100769
- 6x 6311441
- 1x 6257604
- 3x 4211190
- 1x 4211194
- 2x 6307618
- 1x 4211186
- 1x 4211204
- 2x 4221590
- 1x 4211211
- 1x 4217848
- 2x 6186673
- 2x 6401027
- 2x 6238874
- 2x 6337003
- 1x 6313124
- 2x 6290983
- 1x 6338135
- 3x 4216581
- 1x 6284586
- 2x 4211159
- 4x 6102360
- 1x 6342958
- 1x 6075207
- 1x 6228841
- 1x 6428805
- 1x 6267760
- 1x 6093515
- 1x 6422007
- 6x 6248918
- 2x 6271128
- 2x 4595889
- 6x 4211206
- 12x 6310449
- 4x 6159763
- 1x 4609635
- 2x 6261744
- 3x 4211242
- 2x 4211149
- 1x 4211193
- 4x 6201911
- 3x 6062574
- 3x 6103004
- 1x 6153594
- 1x 6036503
- 2x 6151461

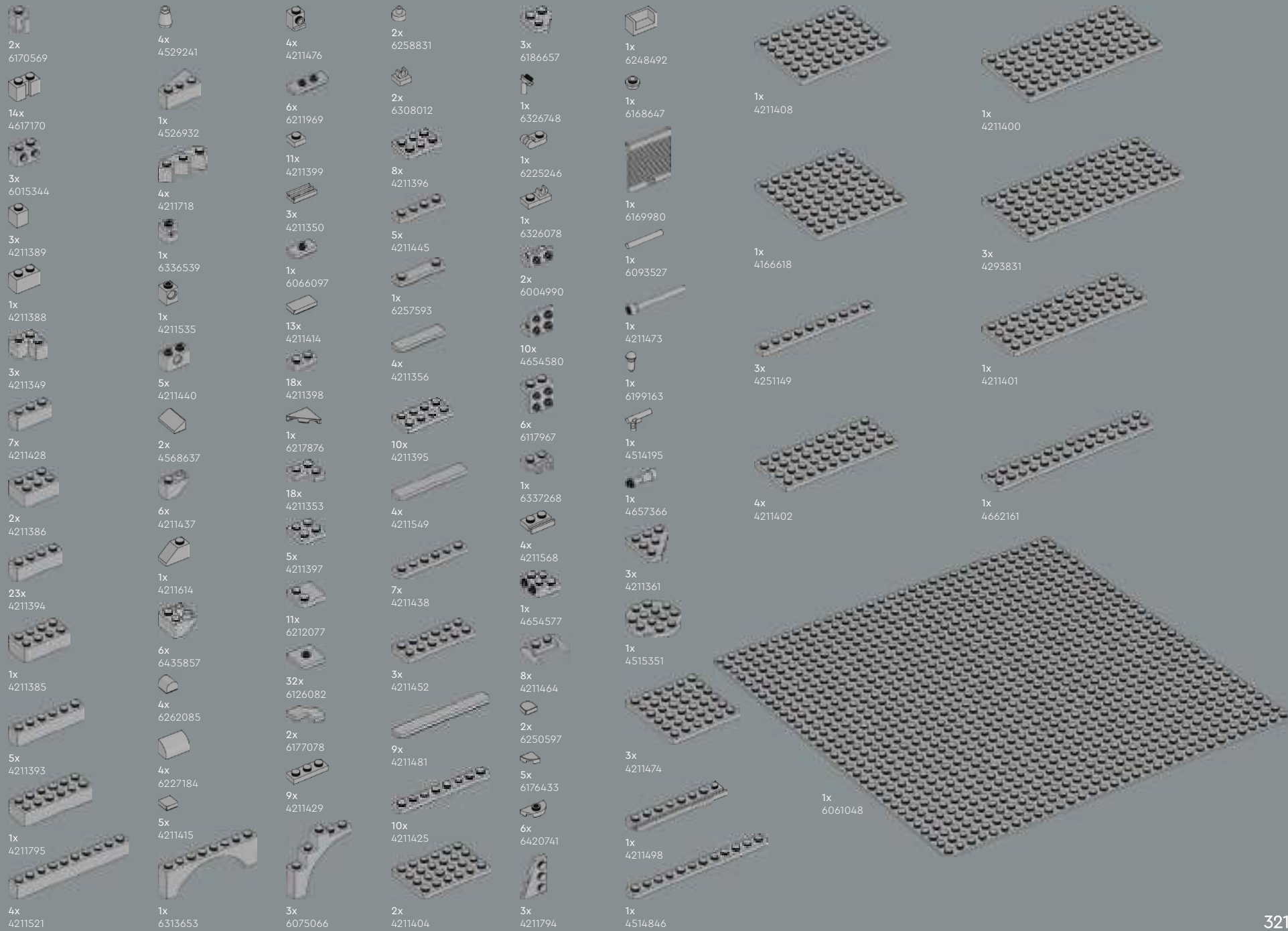

4x
4210719

11x
4210848

1x
4648256

4x
4210631

42x
4211052

16x
6247784

32x
4211055

5x
6309059

4x
6177079

6x
4568734

2x
4211133

3x
4211043

8x
4211053

6x
4211001

10x
6257592

1x
6307616

6x
4560184

1x
4211056

11x
4210651

2x
4210875

5x
4211099

2x
6321746

1x
6170420

1x
6350724

1x
6310596

1x
6245283

3x
6178912

2x
6331222

6x
4211044

1x
4529240

4x
4504378

1x
4211054

4x
4211127

1x
6333129

2x
6029948

2x
4211109

1x
4211103

2x
6271752

1x
6413106

2x
6296892

2x
6000606

18x
4211008

8x
4210997

3x
6133611

2x
6365692

1x
6271127

5x
6284596

1x
6199549

1x
4211042

6x
6115080

2x
6411395

2x
6388124

6x
6209684

1x
6149768

1x
6431074

2x
6344038

2x
6285465

6x
6150307

1x
6058368

1x
6386209

2x
6206151

21x
6022084

42x
6022083

2x
6212064

19x
6201646

35x
6036232

18x
6430416

6x
6380625

2x
6316263

4x
6070301

2x
6316263

4x
6070301

3x
6190252

2x
6102580

11x
6058014

13x
6201647

1x
6248756

2x
6296524

3x
6211356

2x
6296964

3x
6319958

3x
6296501

1x
4549990

2x
4655690

1x
4529247

1x
6335111

8x
6338242

3x
6190252

5x
4523159

1x
6173654

1x
6093529

1x
6038163

3x
6167585

1x
6390147

1x
6158322

10x
6057986

26x
4656783

4x
4569382

4x
6055309

6x
6223183

6x
6135191

1x
6099341

3x
6174192

1x
6273854

1x
6106193

7x
6292154

4x
6021997

4x
6218360

2x
6102994

8x
6177535

1x
6102990

3x
6334099

1x
6187006

2x
6102998

3x
6167700

4x
6093494

3x
6295464

2x
6313600

2x
6347304

4x
6313599

1x
6312464

1x
6163633

2x
4619636

2x
6317181

1x
6096993

9x
6420725

9x
6004943

3x
6154879

4x
6004938

1x
6404754

4x
6133838

4x
6151658

10x
6151664

3x
6133728

1x
6210675

7x
6151657

3x
6223733

1x
4258308

1x
6420734

2x
6092111

2x
6278156

1x
4540203

2x
4211469

2x
6251591

2x
6078236

1x
6227939



LEGO.com/service



YOU COULD WIN



YOU COULD WIN

Your feedback will help shape the future development of this product series.

Visit:

DU KÖNNTEST GEWINNEN

Dein Feedback trägt zur Weiterentwicklung dieser Produktreihe bei.

Geh auf:

VOUS POURRIEZ GAGNER

Vos commentaires nous aideront à concevoir les futurs produits de cette gamme.

Visitez :

POTRESTI VINCERE TU

La tua opinione ci aiuterà a migliorare la creazione futura di questa linea di prodotti.

Visita:

PUEDES GANAR

Tu opinión contribuirá al futuro de esta serie de productos.

Visita:

轻松获奖

您的反馈将有助于我们在今后改进本产品系列。

请访问:

[LEGO.com/productfeedback](https://www.lego.com/productfeedback)

You also have the chance to win a LEGO® set.

Terms and conditions apply.*

Außerdem hast du die Chance, ein LEGO® Set zu gewinnen.

Es gelten die Teilnahmebedingungen.*

Vous pourriez également gagner un ensemble LEGO®.

Des conditions s'appliquent.*

Hai anche la possibilità di vincere un set LEGO®.

Termini e condizioni sono applicabili.*

También tienes la oportunidad de ganar un set LEGO®.

Aplican términos y condiciones.*

您还有机会赢取乐高®套装。

条款和条件适用。*

*[LEGO.com/productfeedback-terms](https://www.lego.com/productfeedback-terms)

