



76272



Q LEGO® Builder





[LEGO.com/sustainable-packaging](https://LEGO.com/sustainable-packaging)



**FR**  
**DONNEZ**  
OU  
**RECYCLEZ**

 OU  OU 

ASSOCIATION    MAGASIN    DÉCHÈTERIE

Adresses sur [quefairedemesdechets.fr](https://quefairedemesdechets.fr)



Q LEGO® Builder

# BUILDER



Apple and the Apple logo are trademarks of Apple Inc., registered in the U.S. and other countries and regions. App Store is a service mark of Apple Inc. Google Play and the Google Play logo are trademarks of Google LLC. Tencent and the Tencent logo are trademarks of Tencent Inc.

Q [LEGO.com/devicecheck](https://www.lego.com/devicecheck)

**EN** Ask parents' permission before going online | **DE** Eltern um Erlaubnis bitten, bevor du online gehst | **FR** Demande l'autorisation d'un parent avant d'aller en ligne | **IT** Chiedi il permesso ai tuoi genitori prima di andare online | **ES** Pídeles permiso a tus papás antes de conectarte a Internet | **PT** Pede autorização aos pais antes de acederes online | **ZH** 上网前应先征得父母的同意 | **PL** Poproś rodziców o zgodę, zanim wejdiesz do Internetu | **CS** Než půjdeš na internet, požádej rodiče o svolení | **SK** Skôr než pôjdeš na internet, vypýtaj si povolenie od rodičov | **HU** Kérj szülői engedélyt, mielőtt online csatlakoznál! | **RO** Cere permisiunea părinților înainte de a te conecta online | **BG** Поискайте разрешение от родител, преди да влезете онлайн | **LV** Pirms došanās tiešsaistē palūdz atļauju vecākiem | **ET** Enne Interneti kasutamist küsi vanematelt luba | **LT** Prieš prisijungdami prie interneto, atsiklauskite tėvų





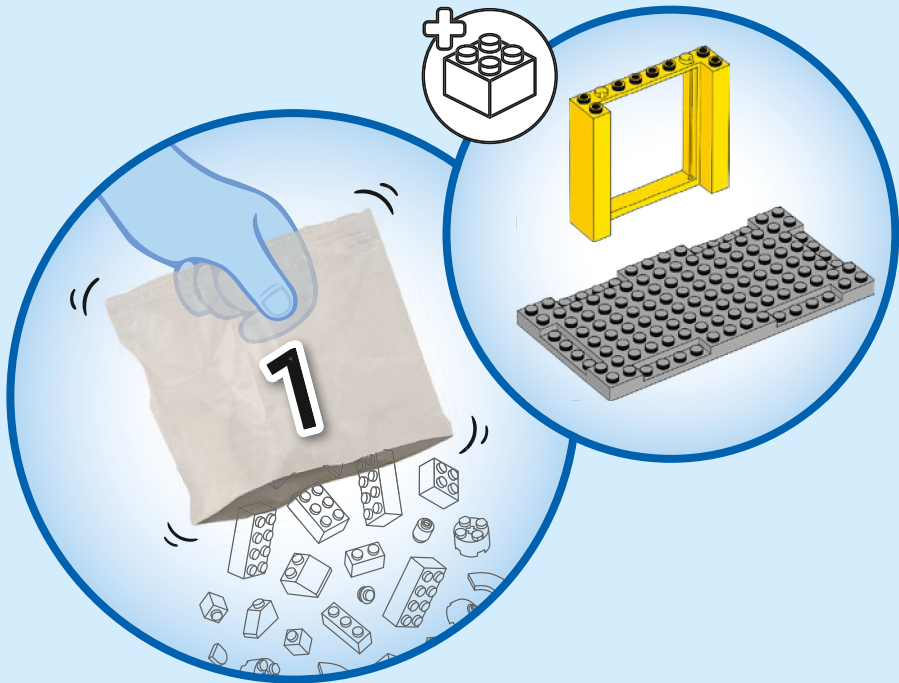

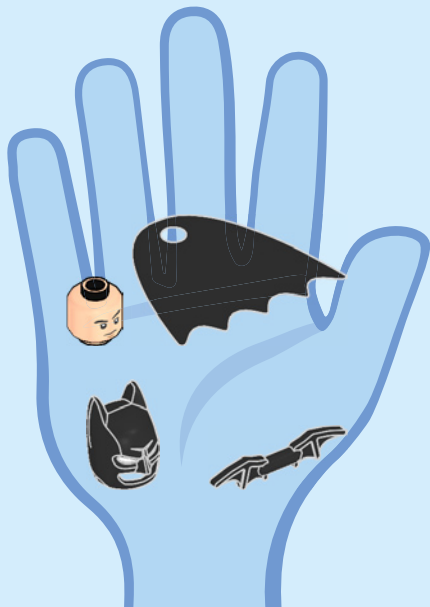
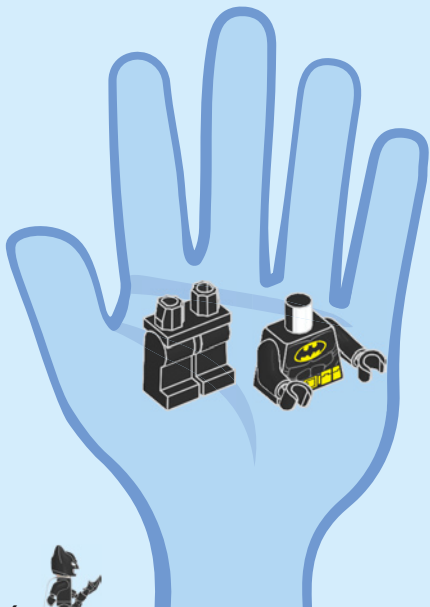

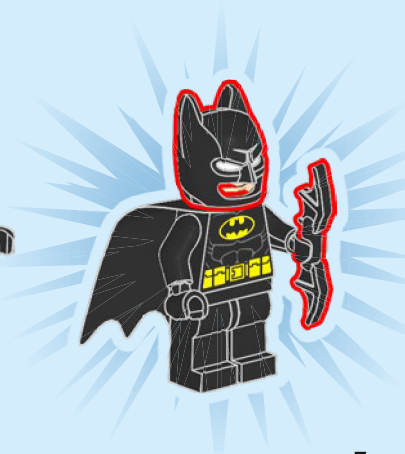
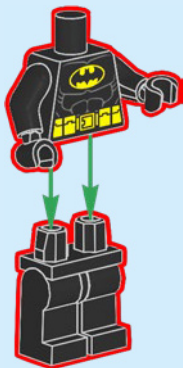

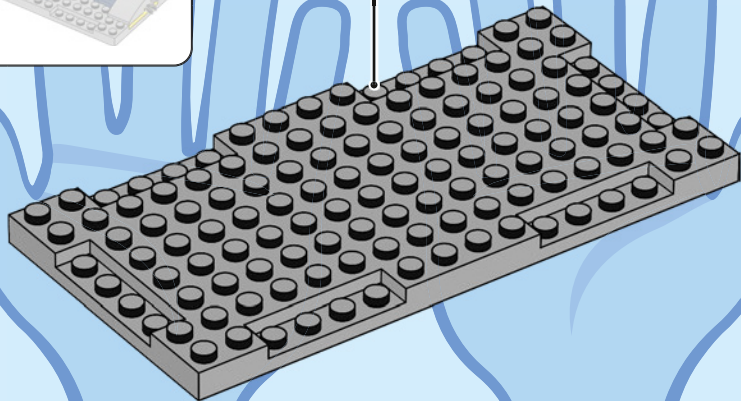
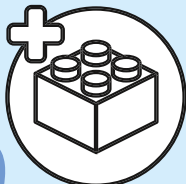
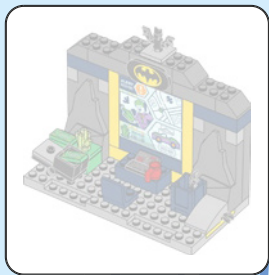



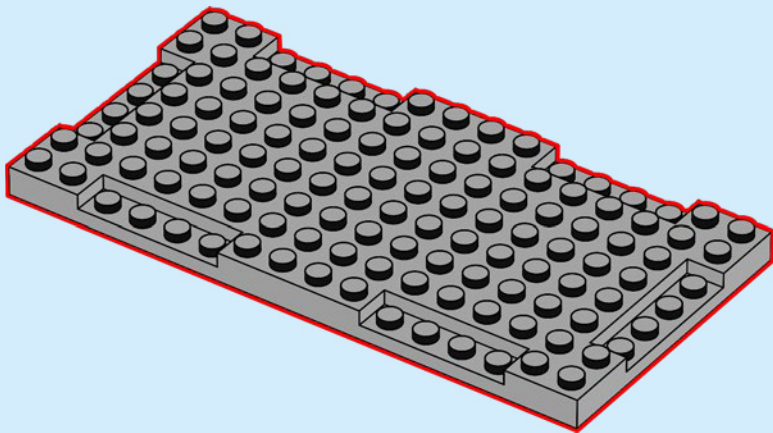

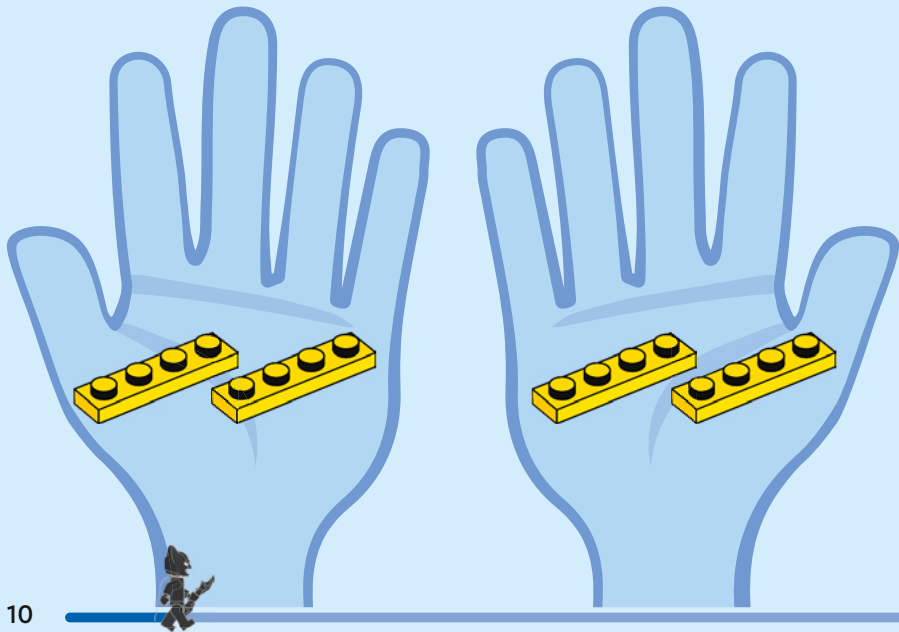

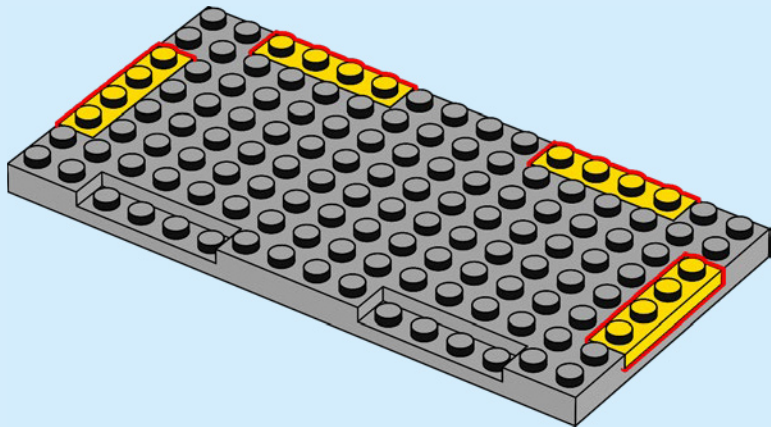

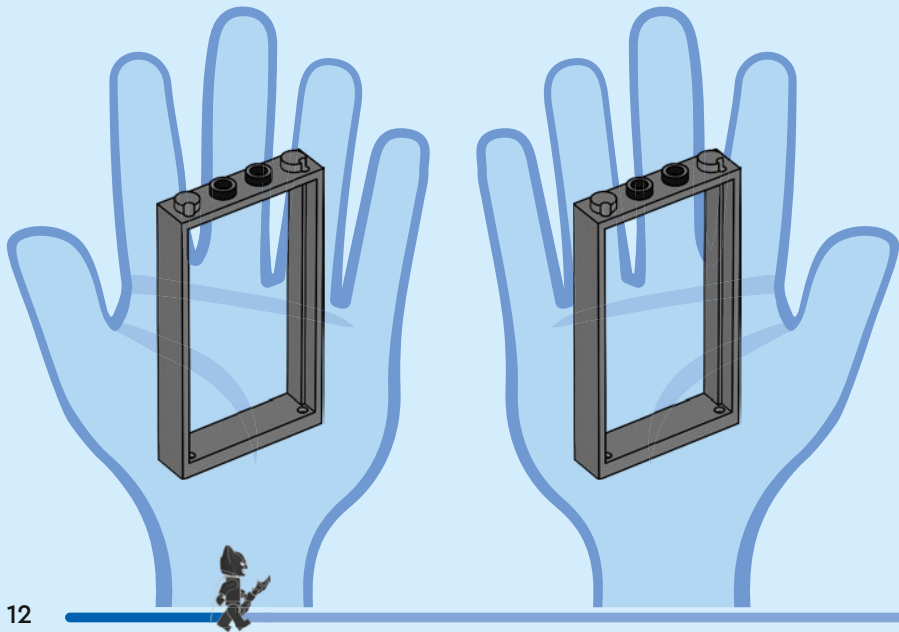

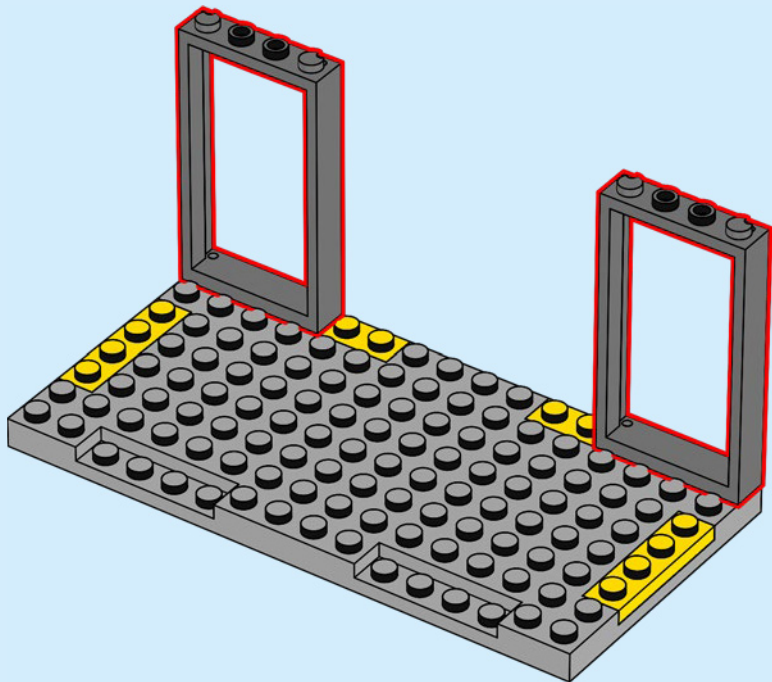

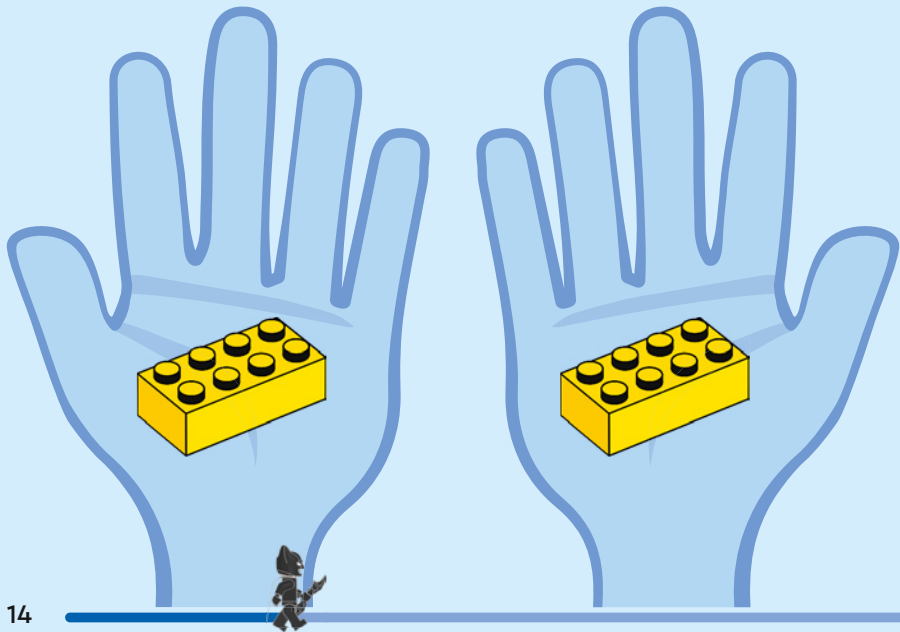

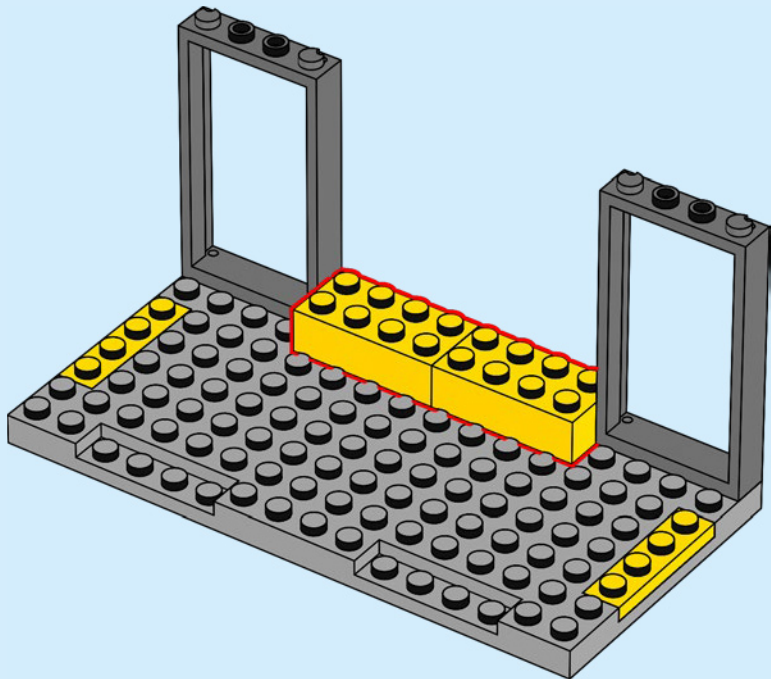

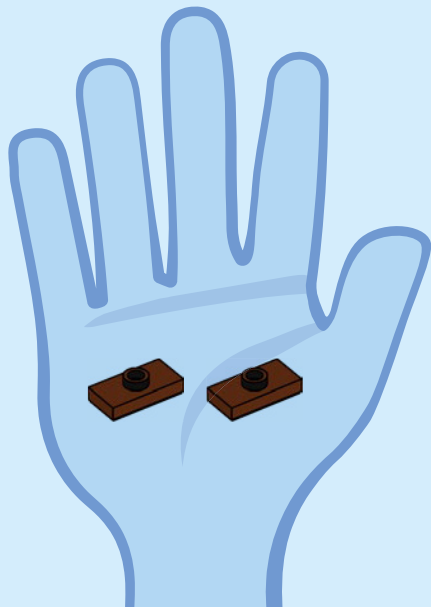



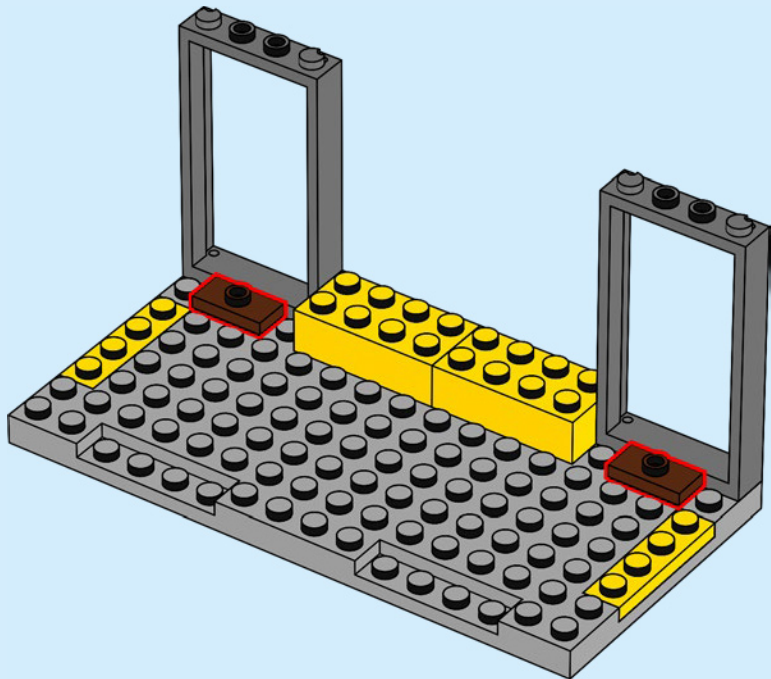

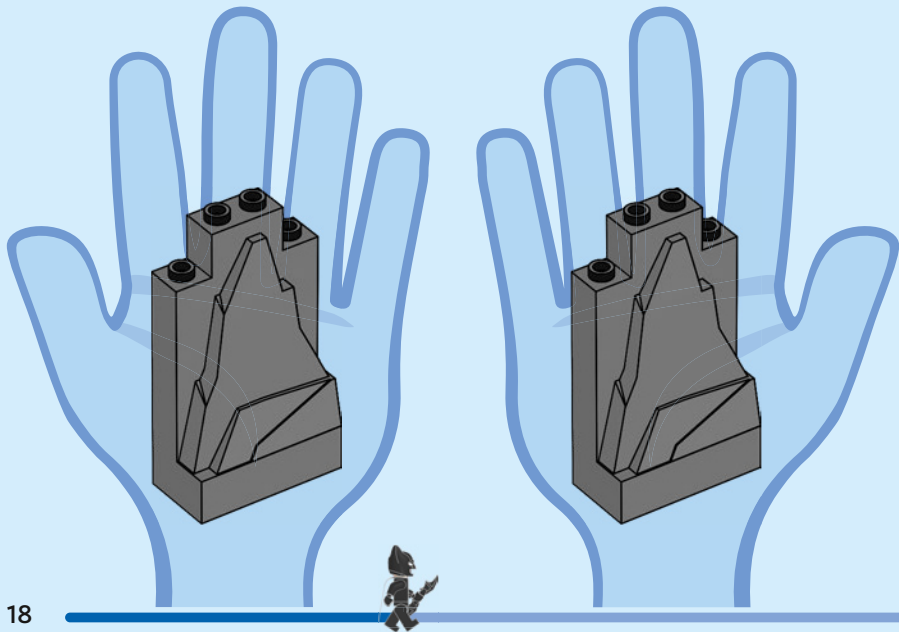

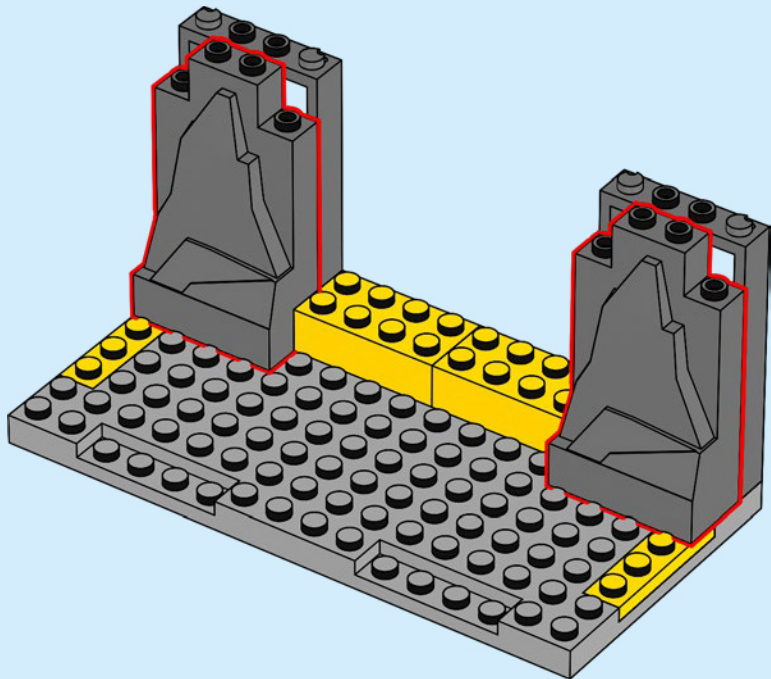

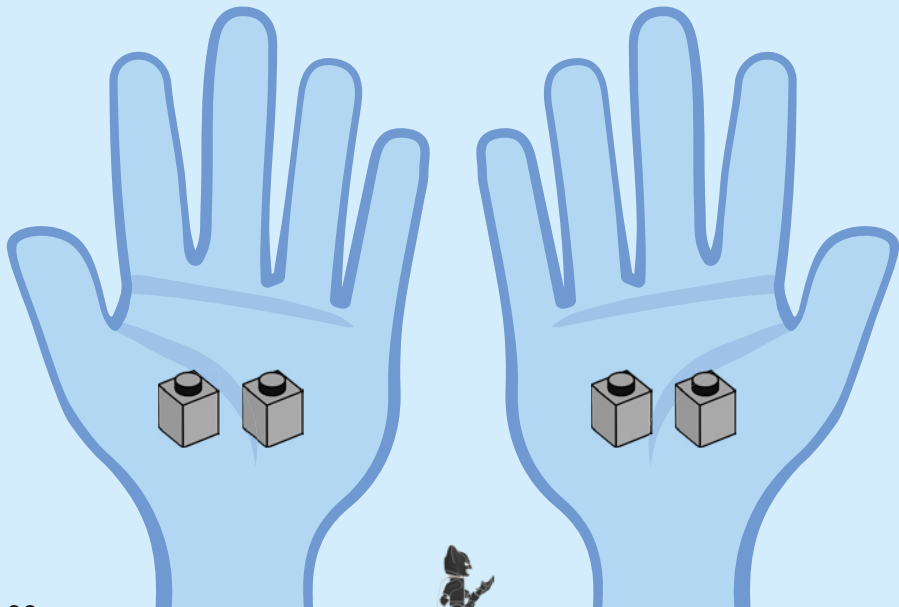

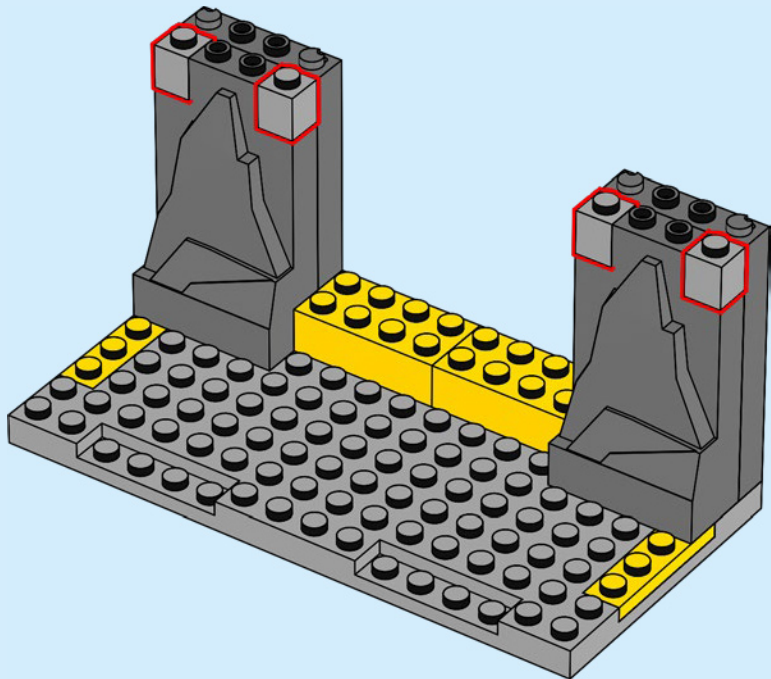

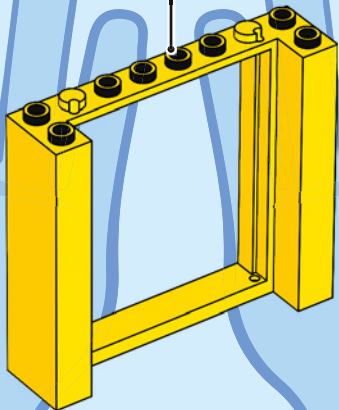
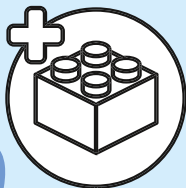

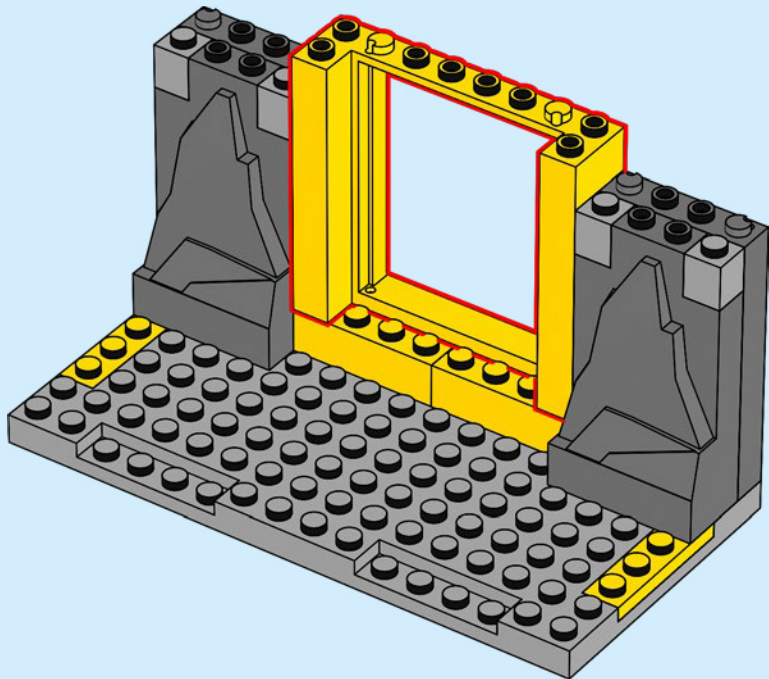

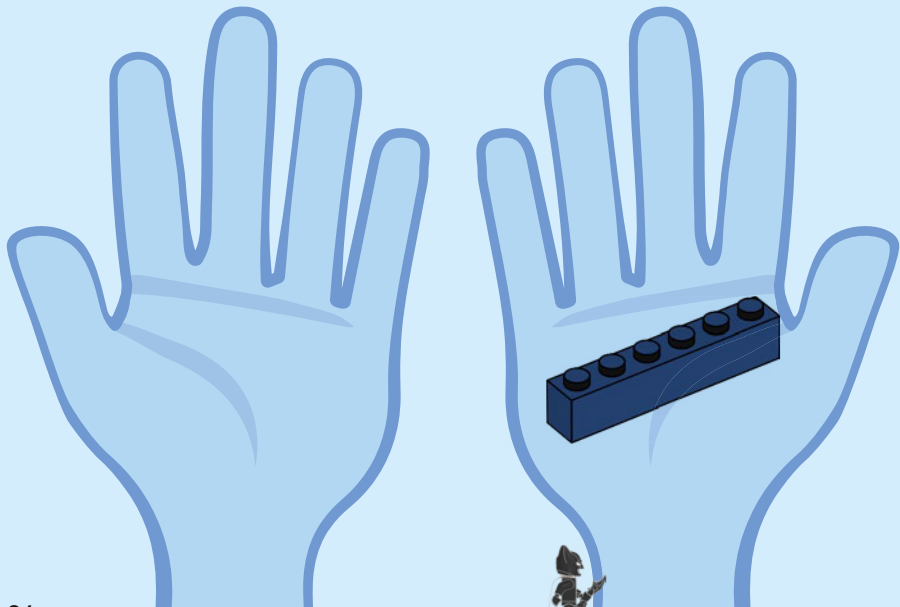



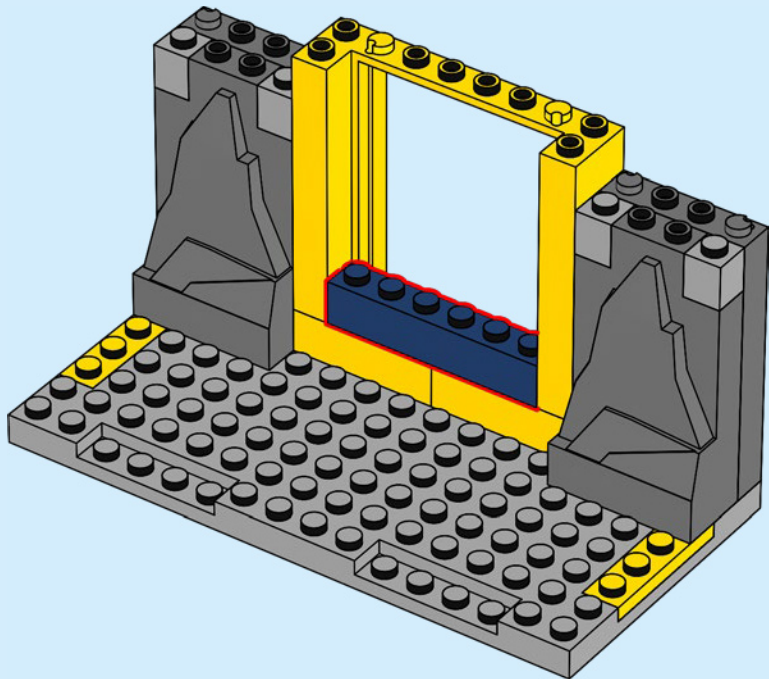



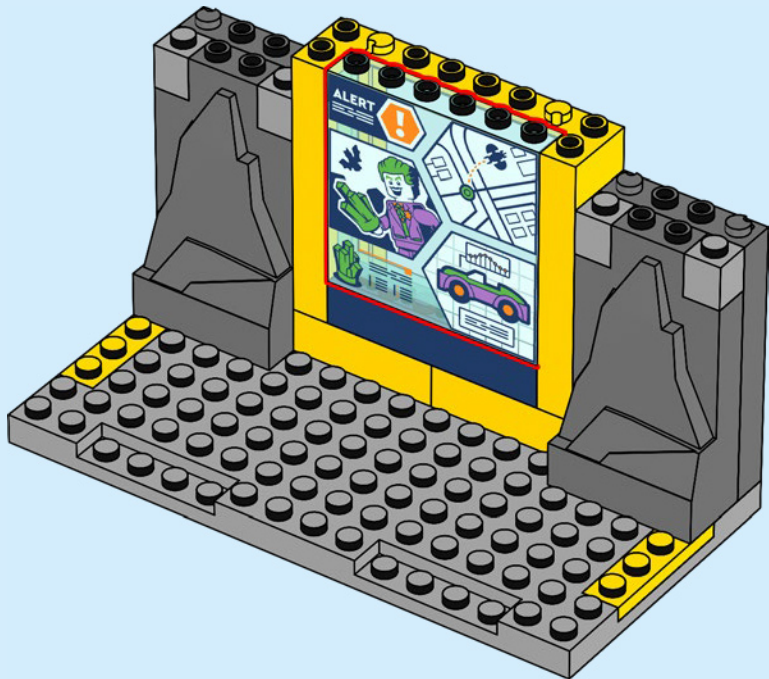

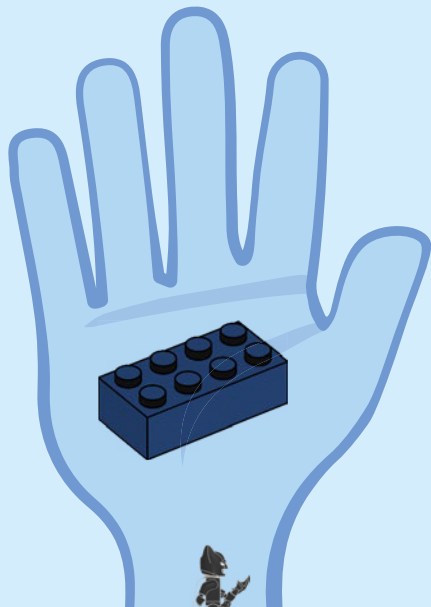
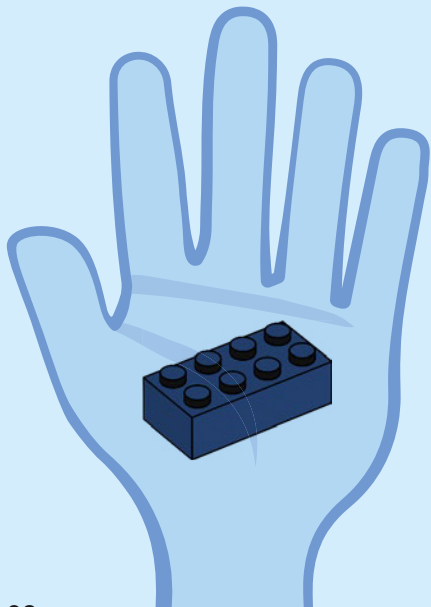

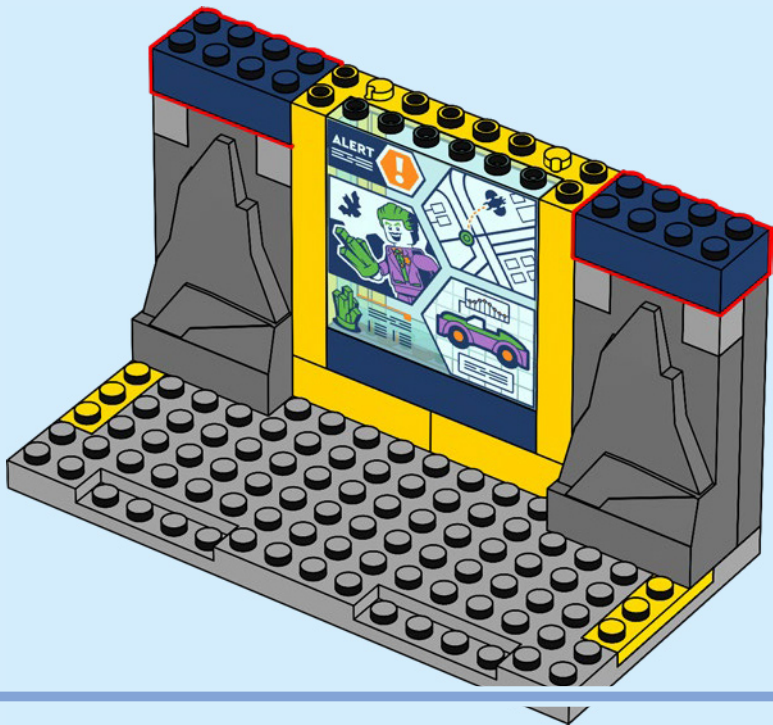

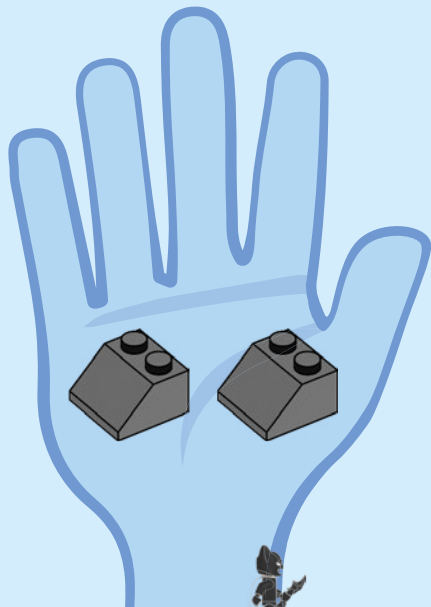
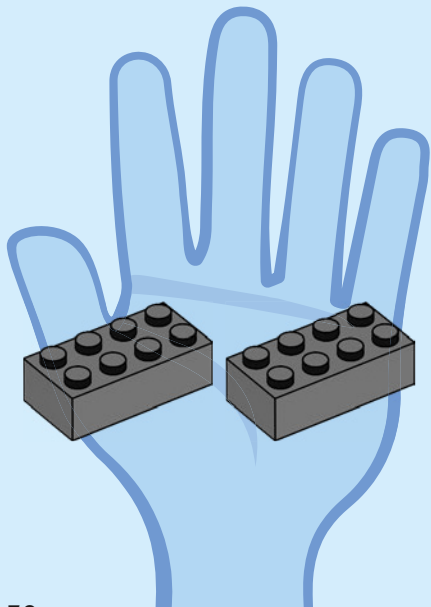

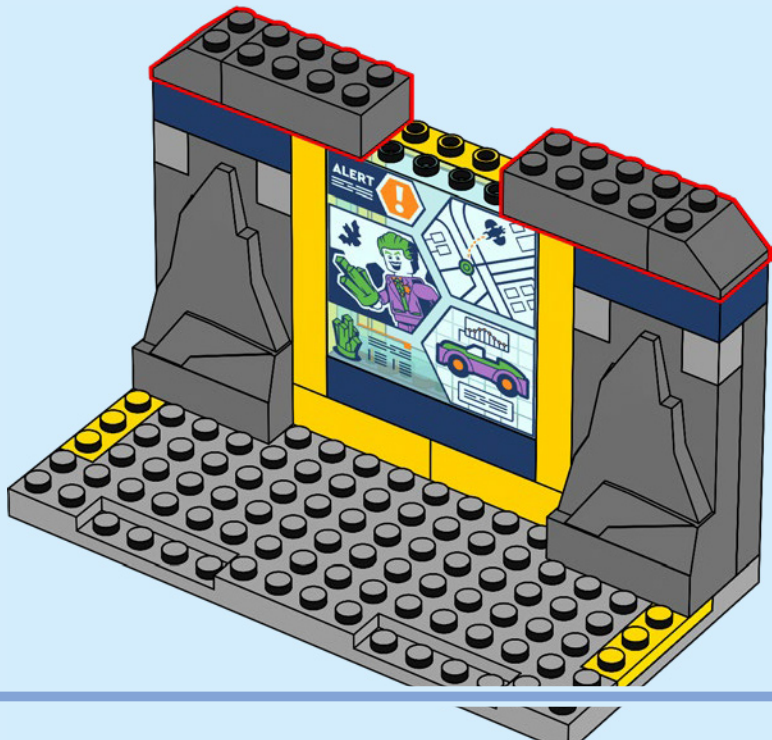

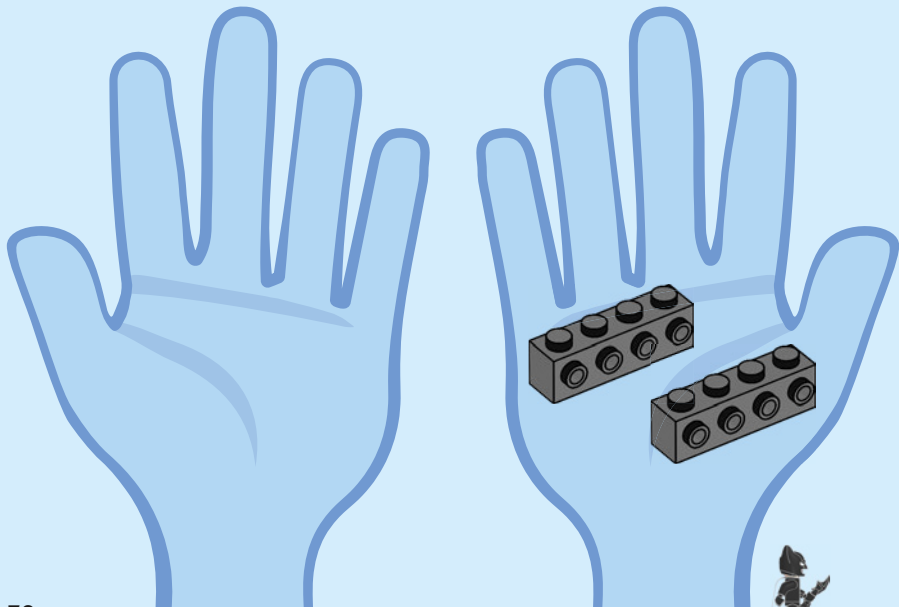



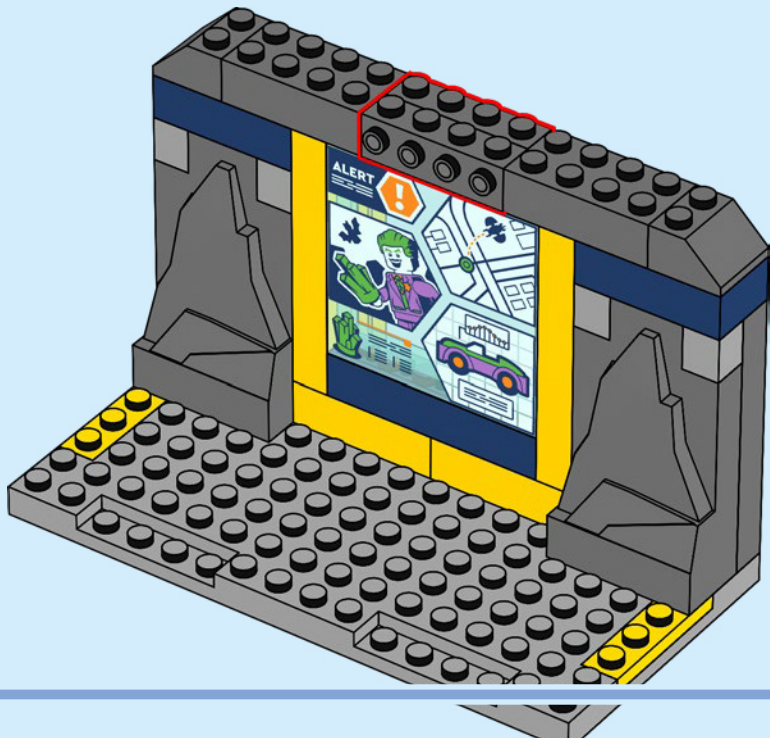

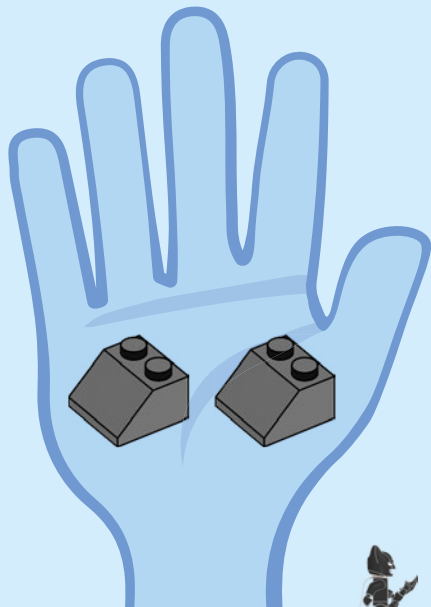
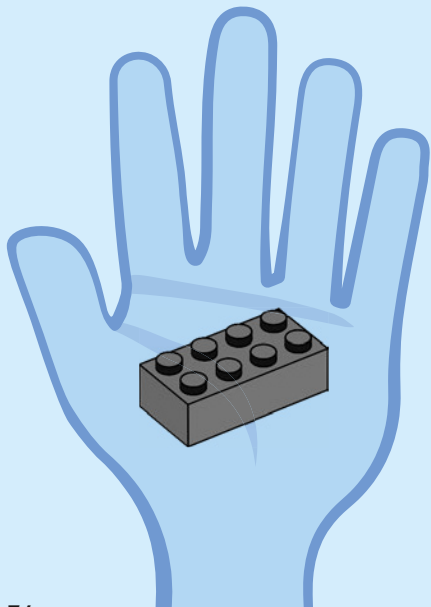

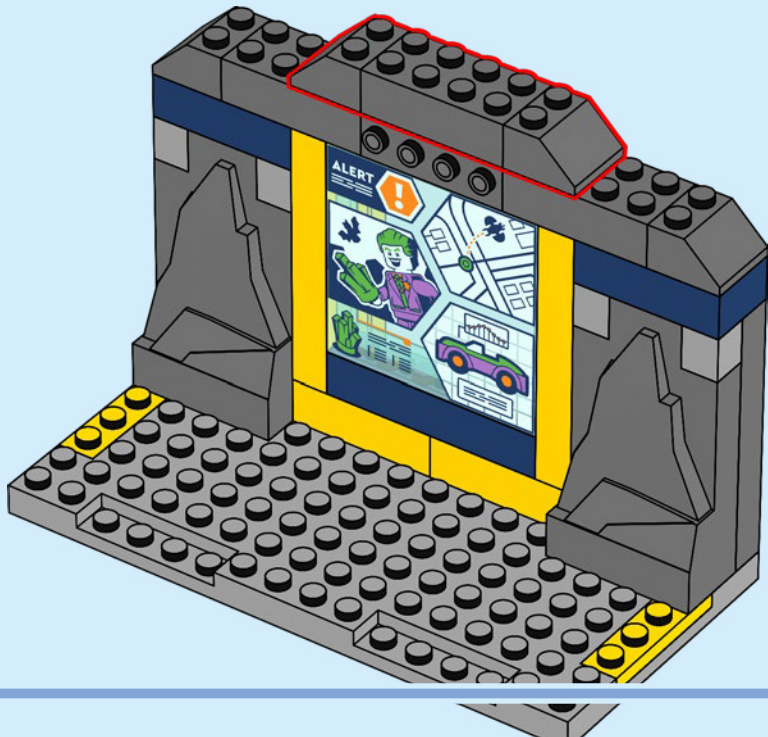

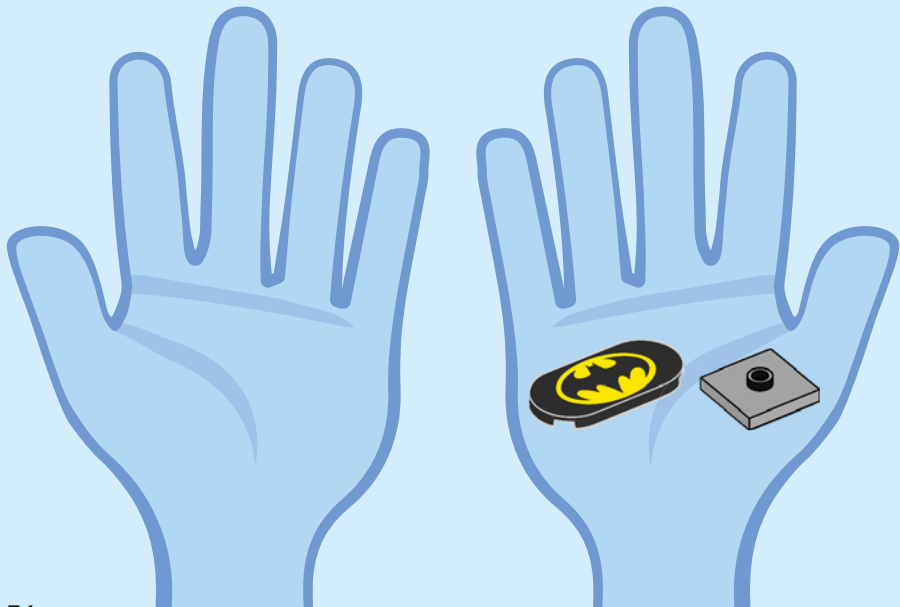

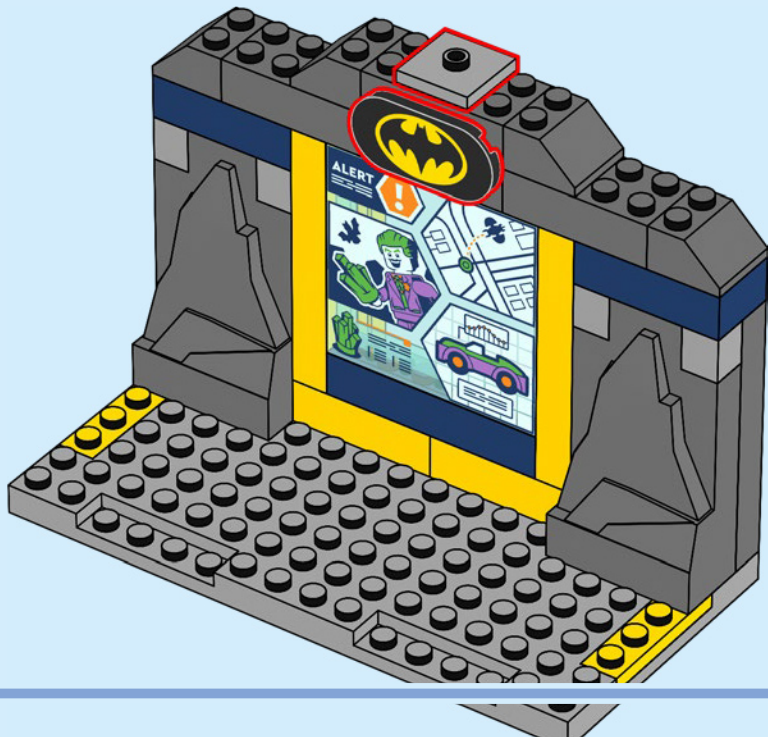



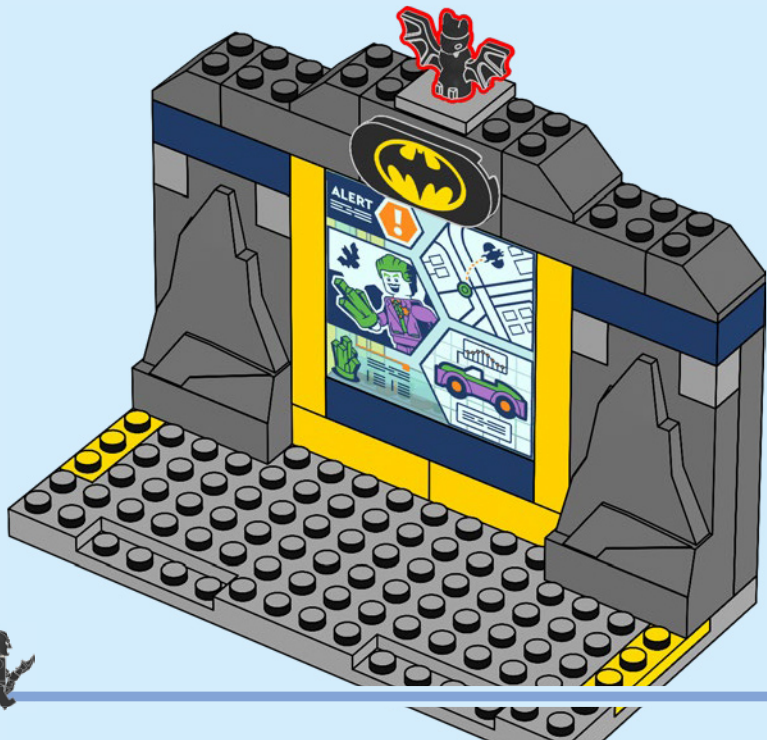

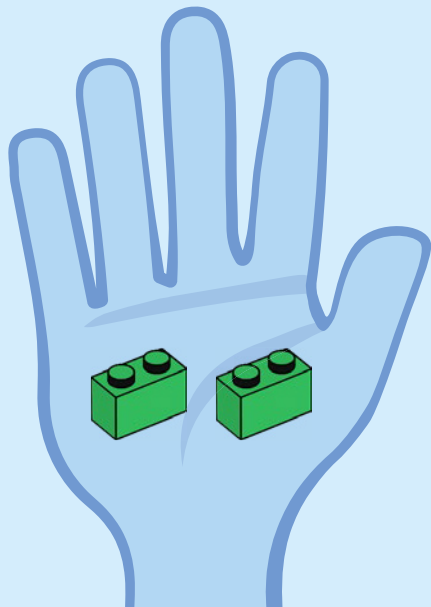
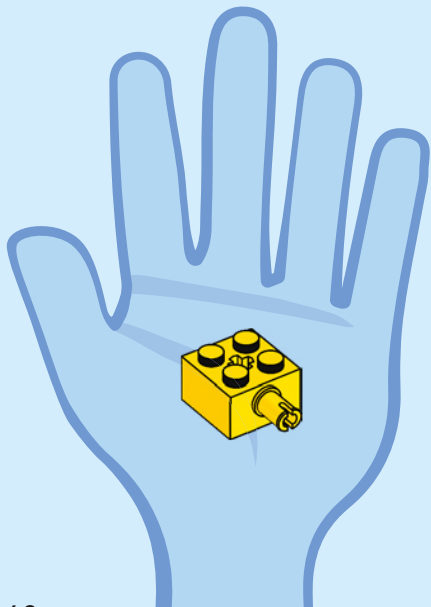





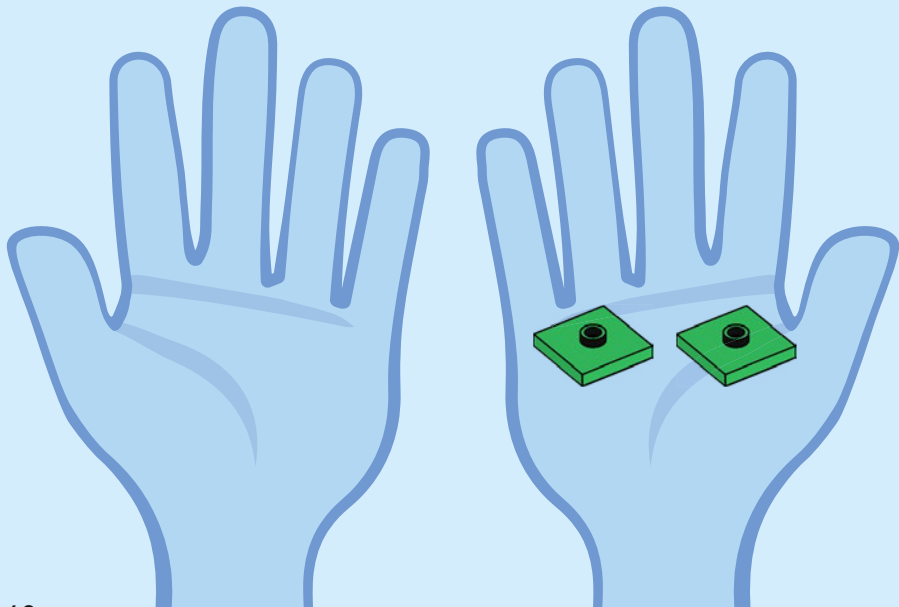

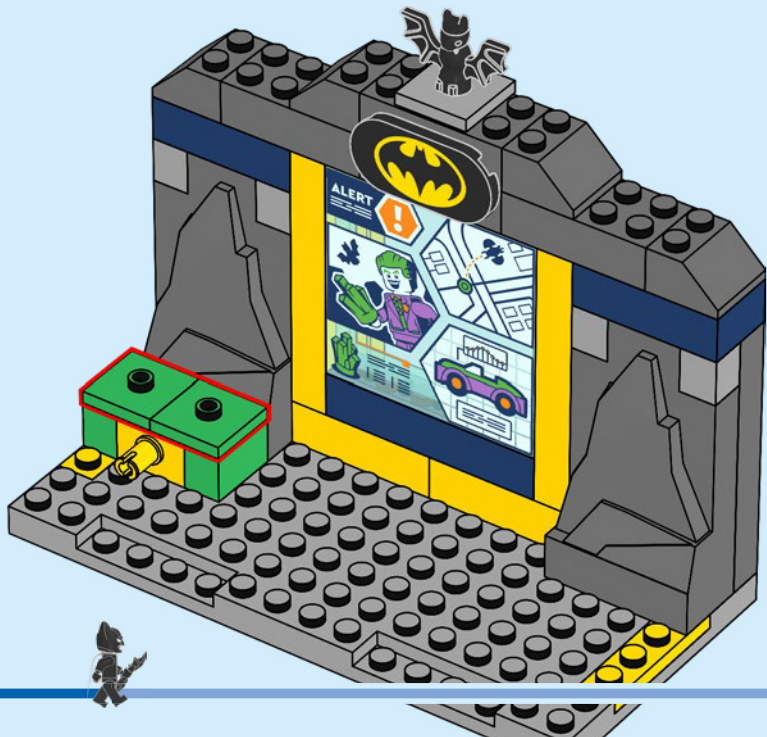

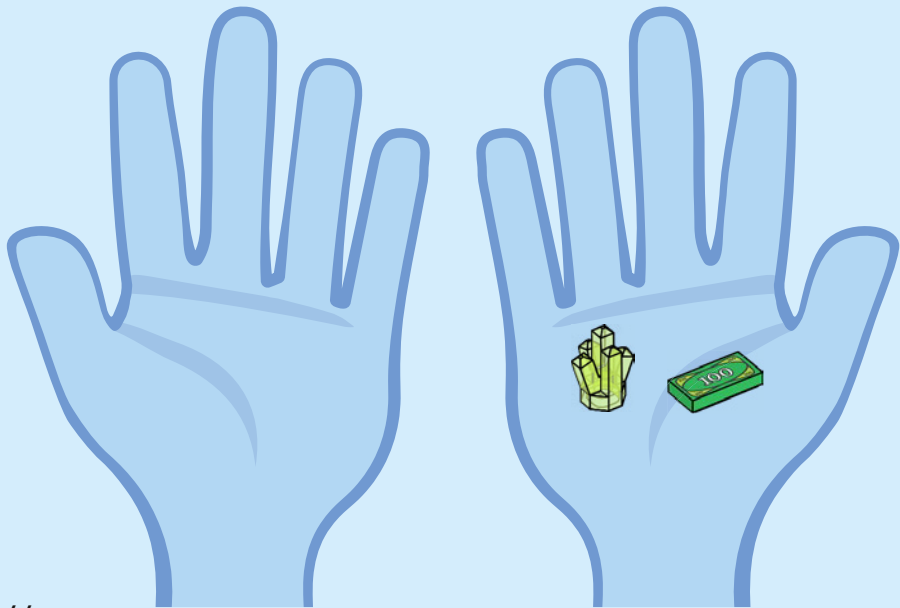

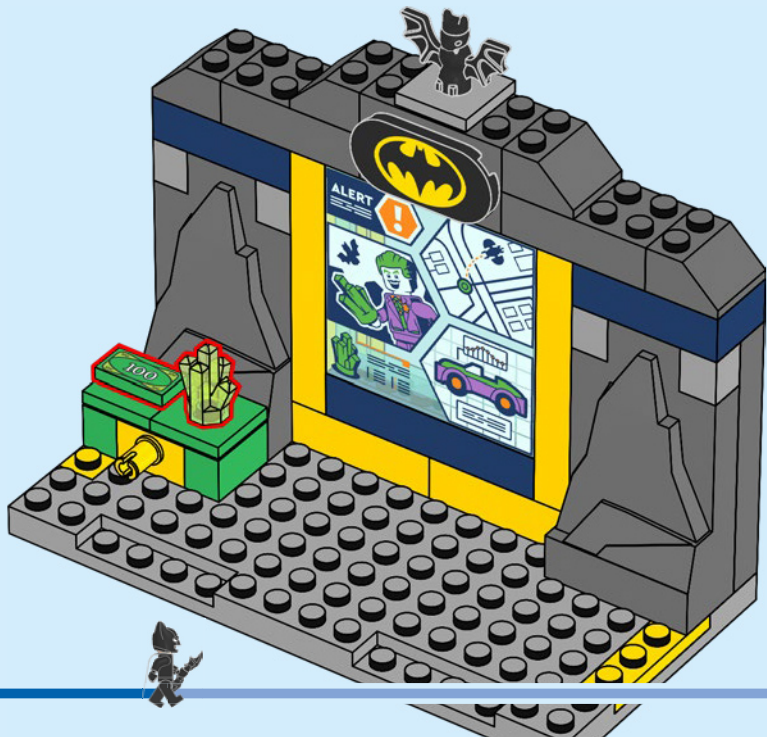

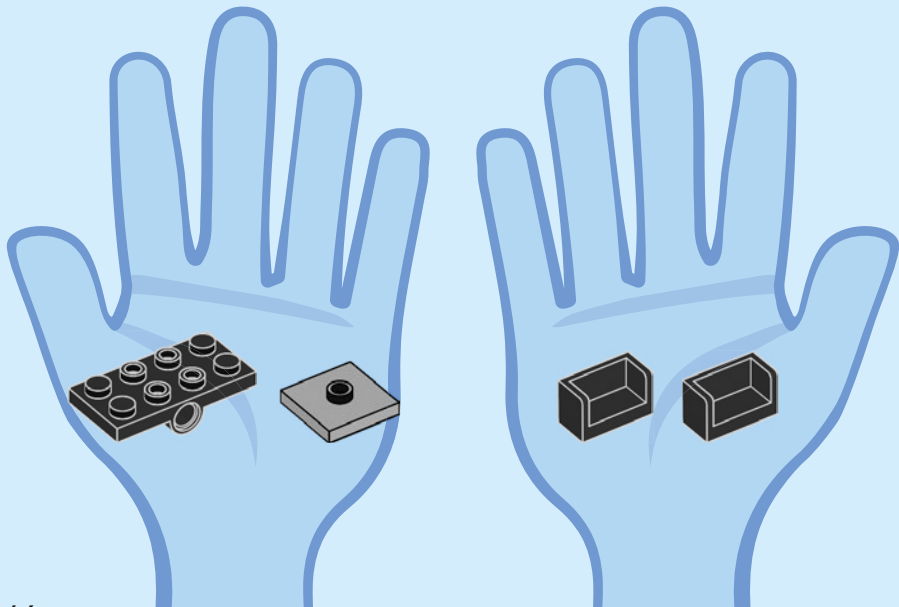

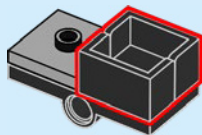
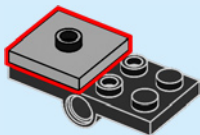
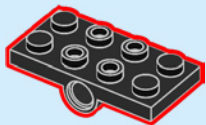

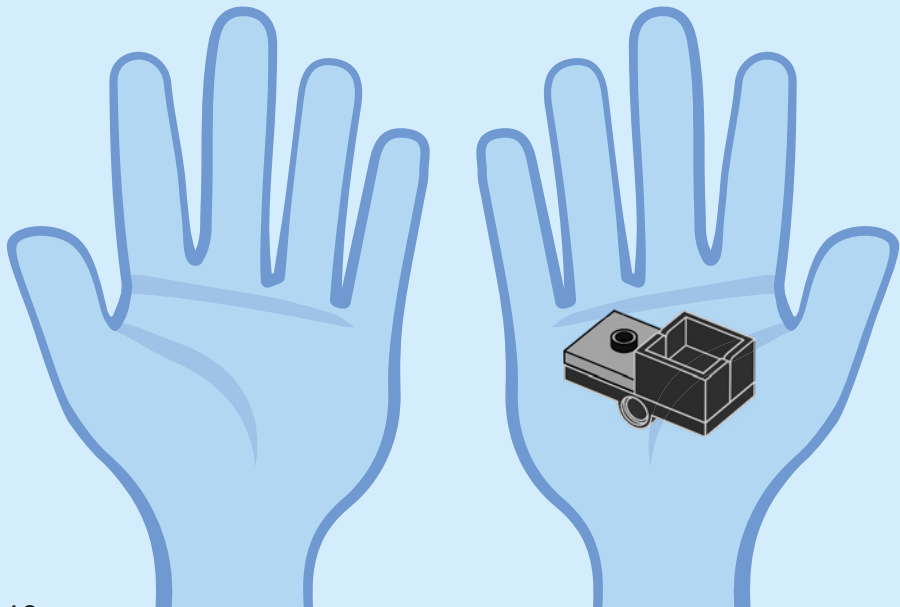



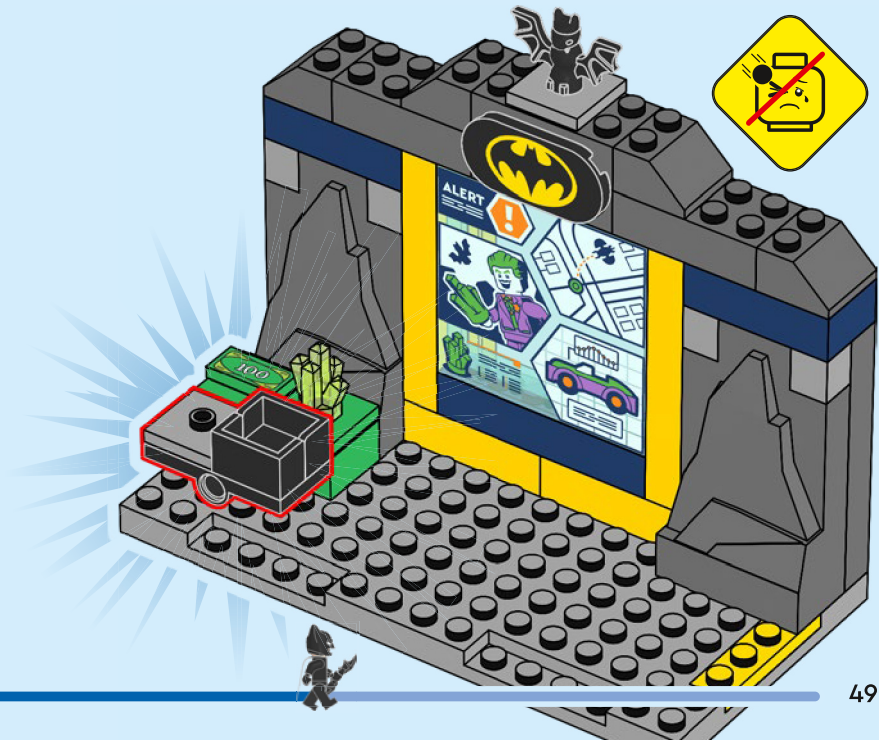

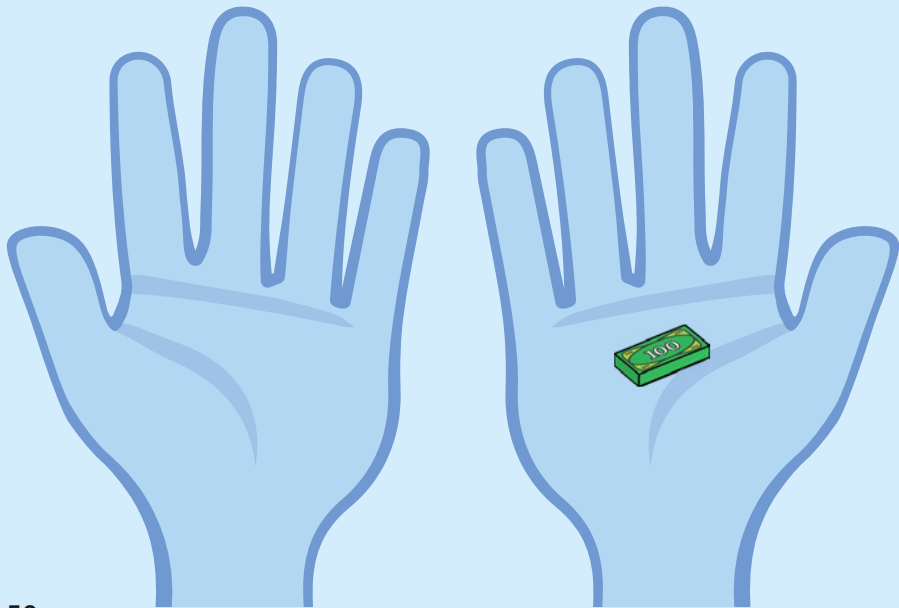

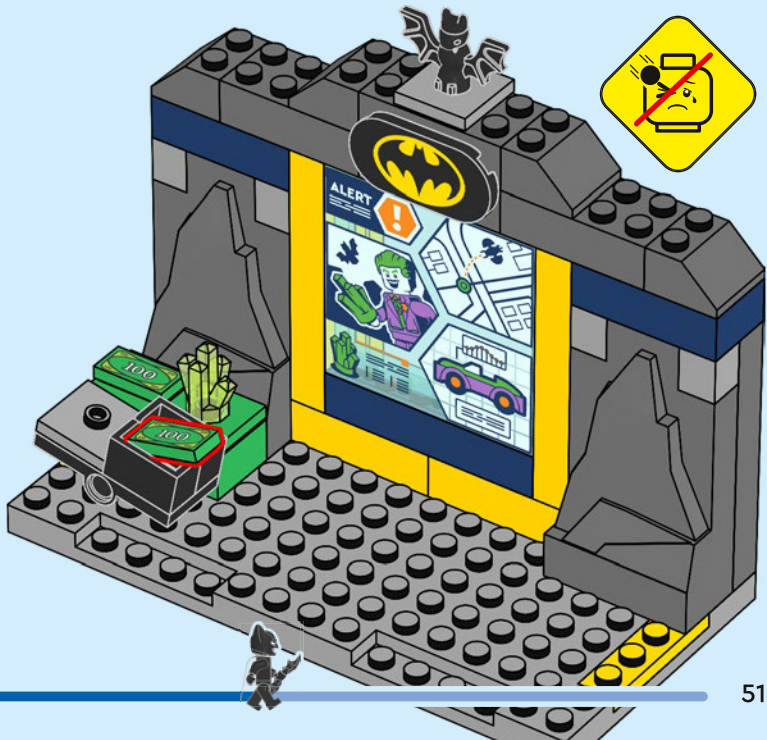

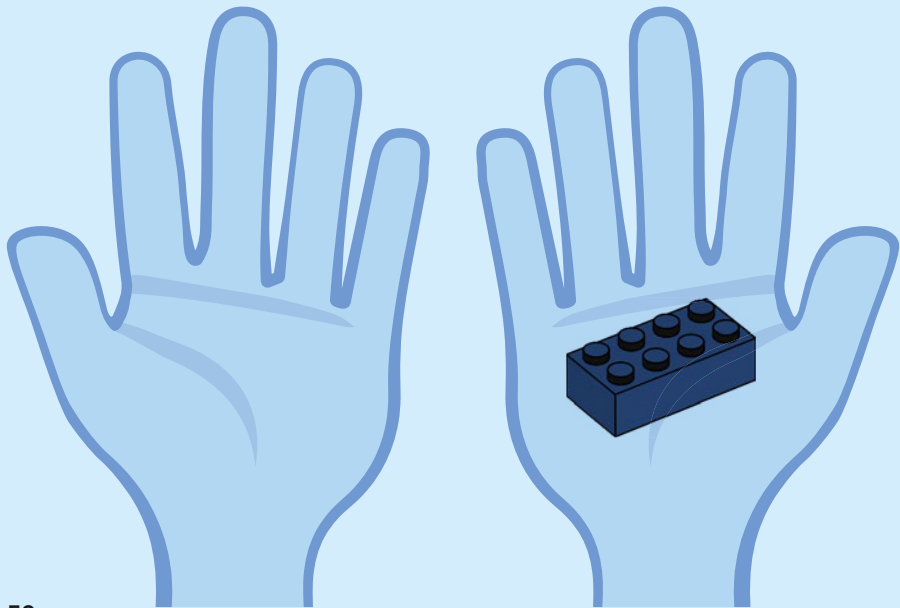

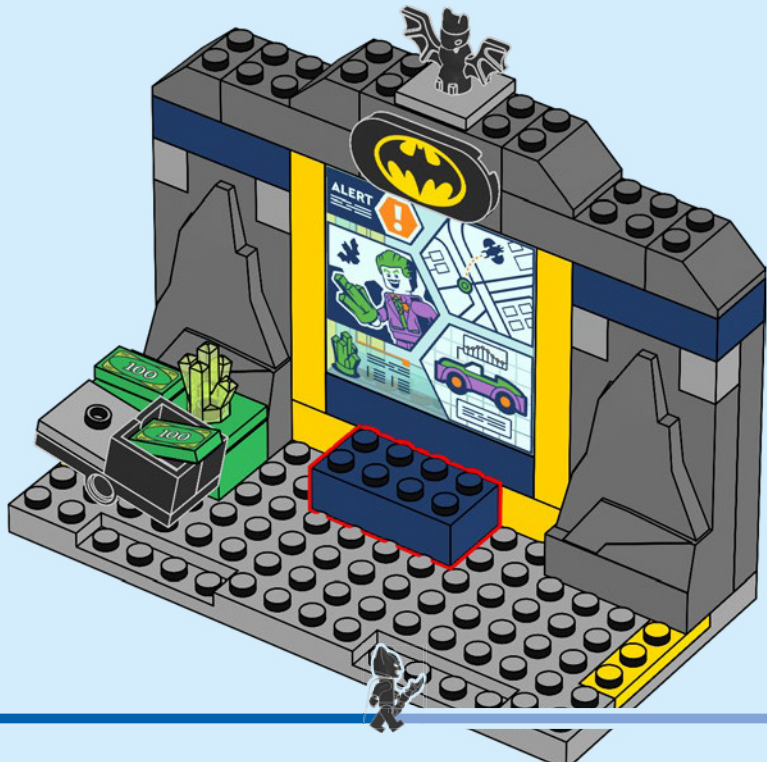

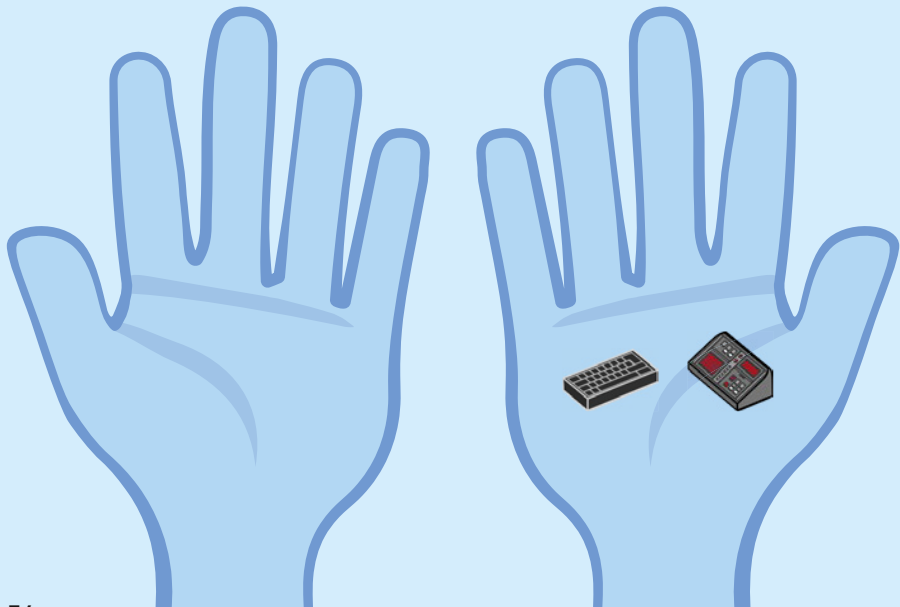

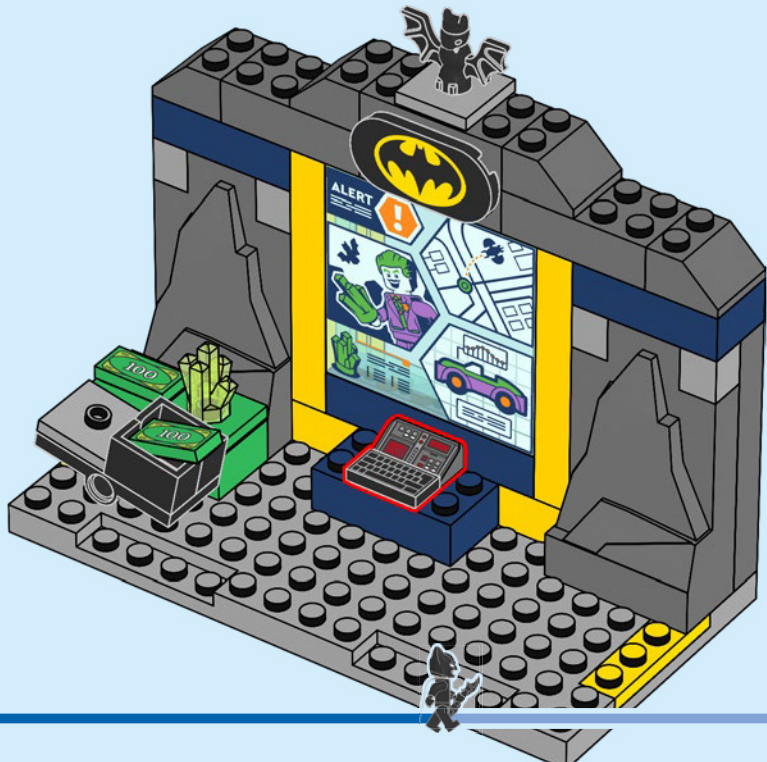

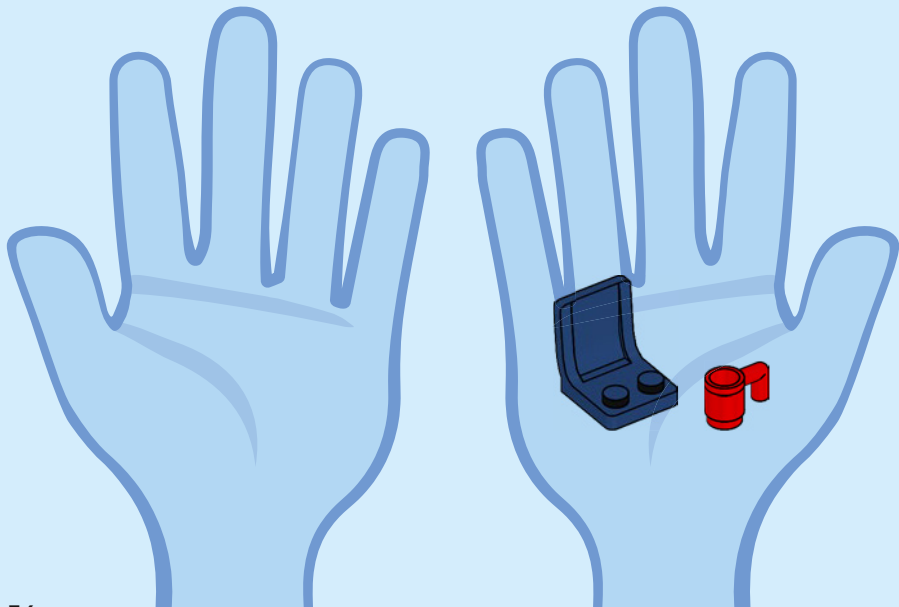



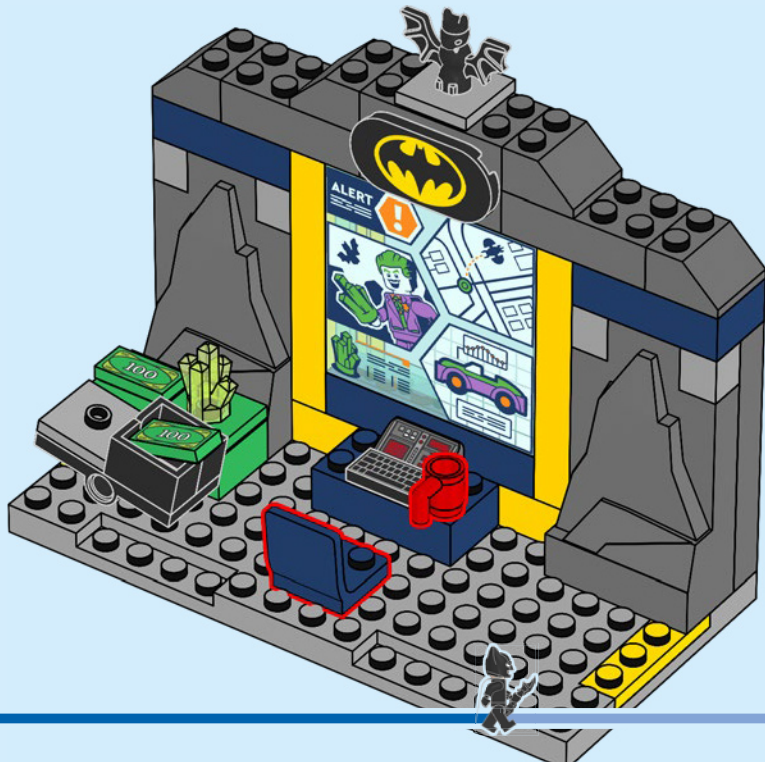

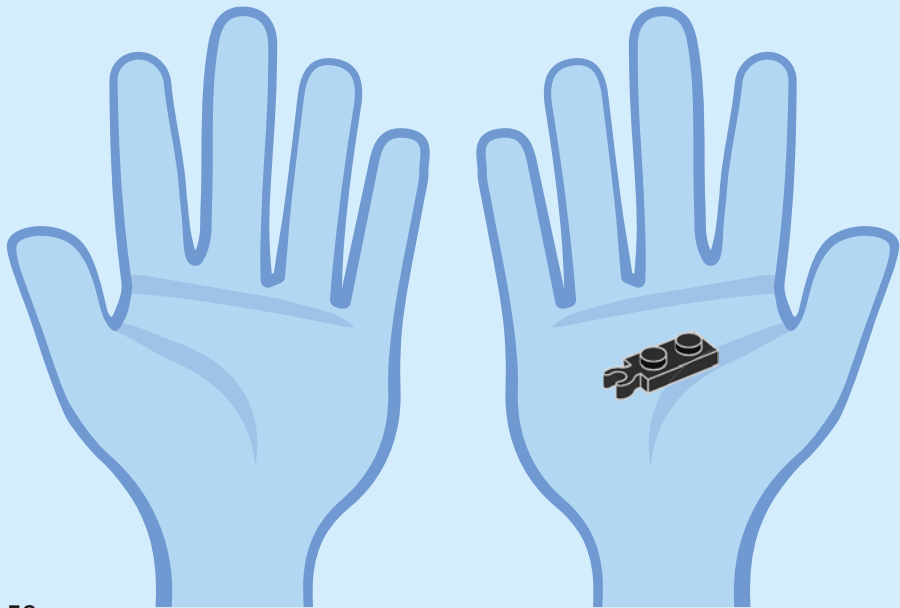

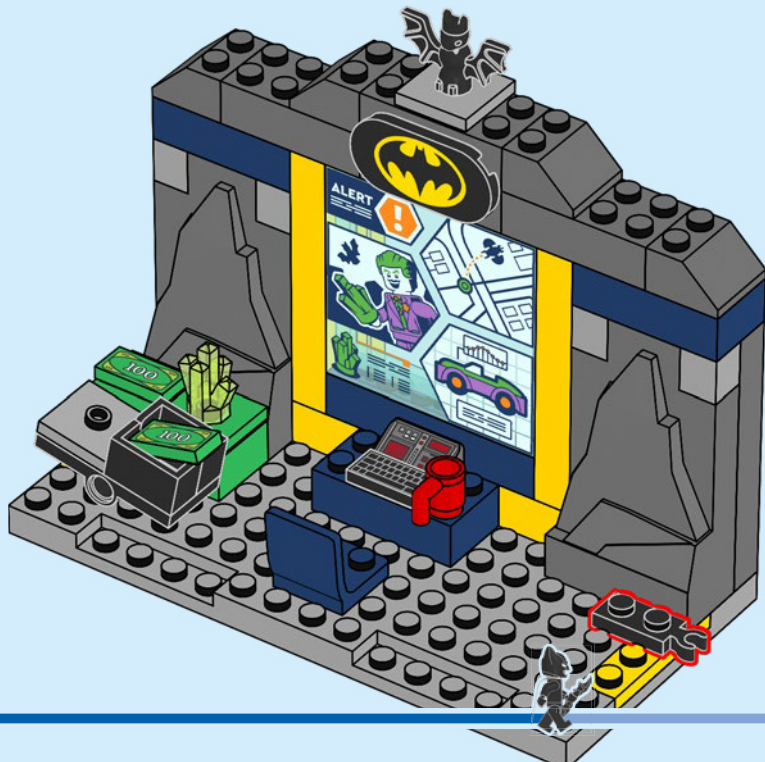

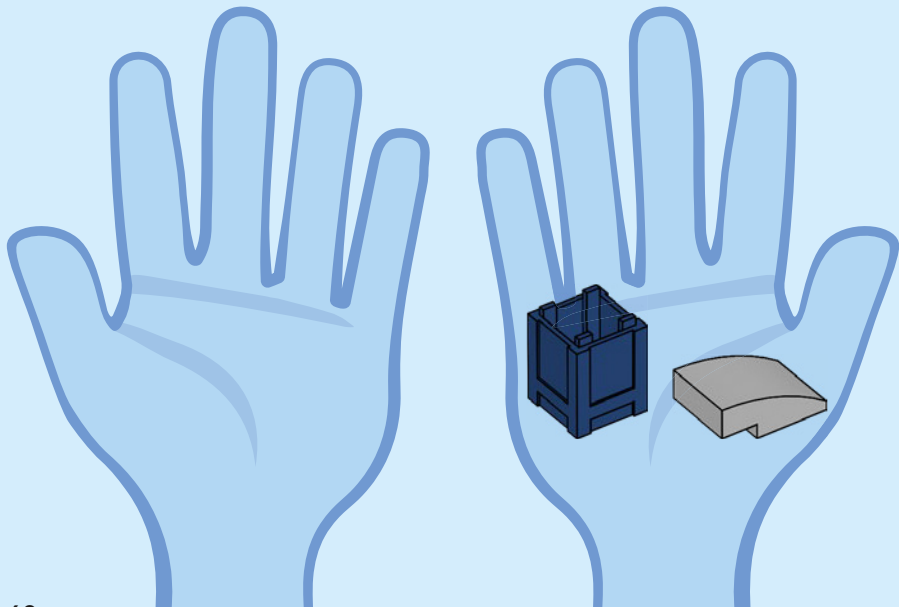

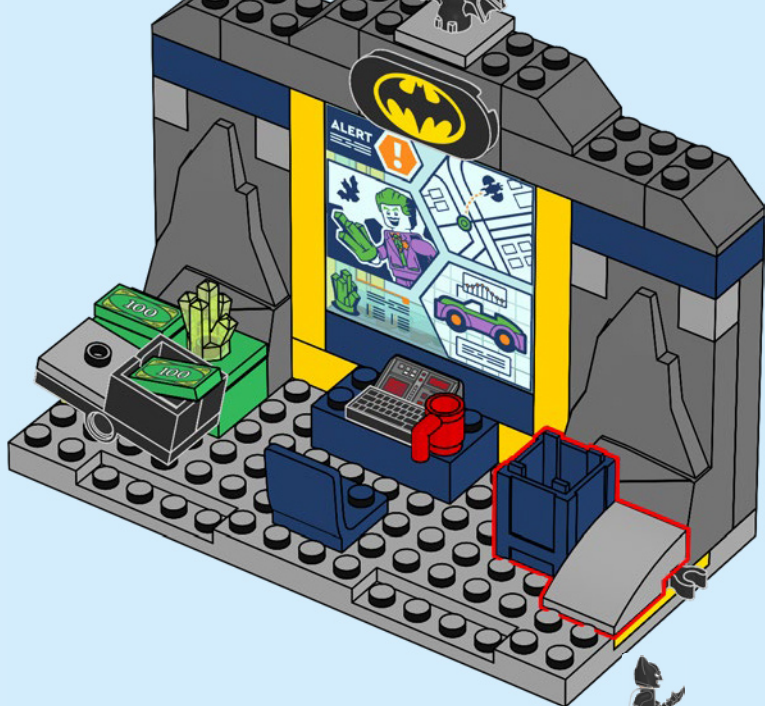

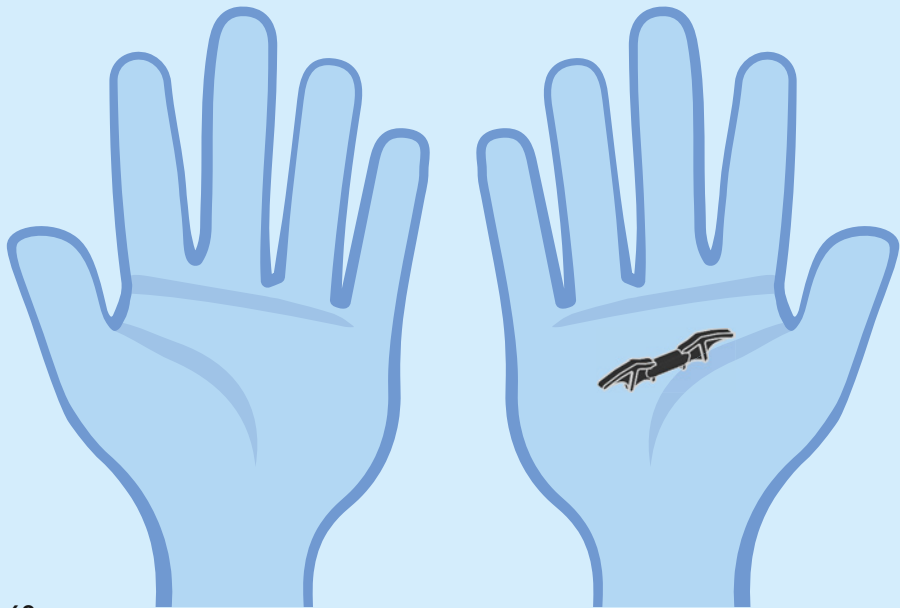

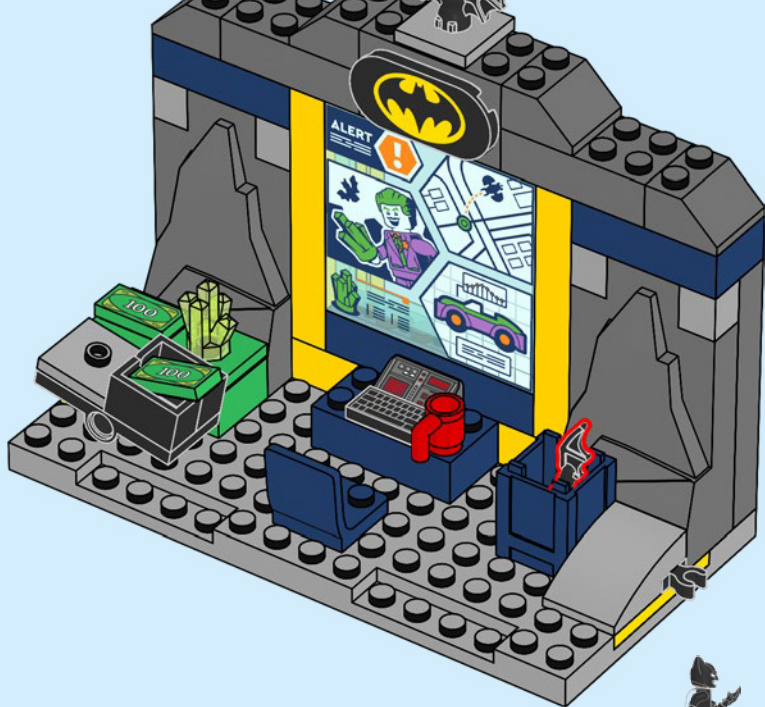

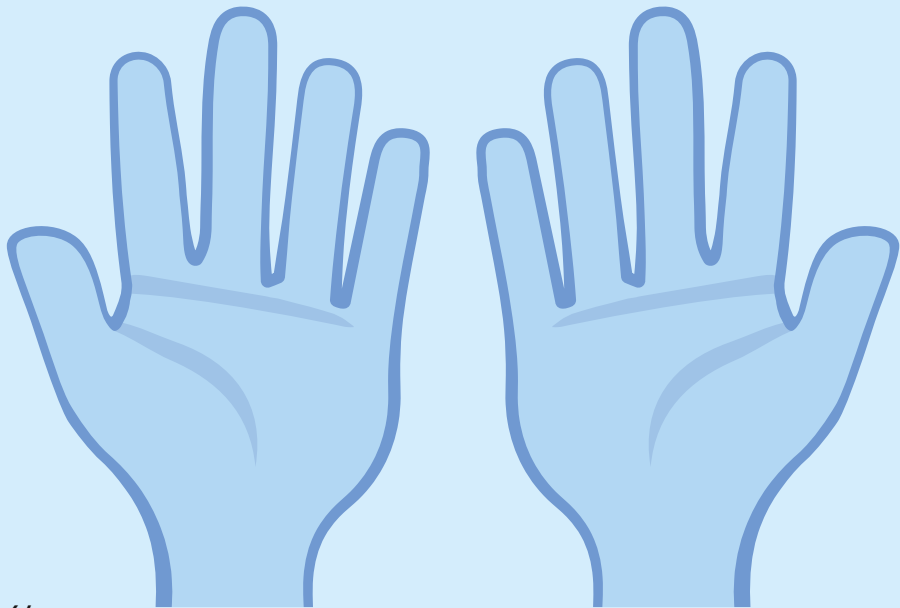



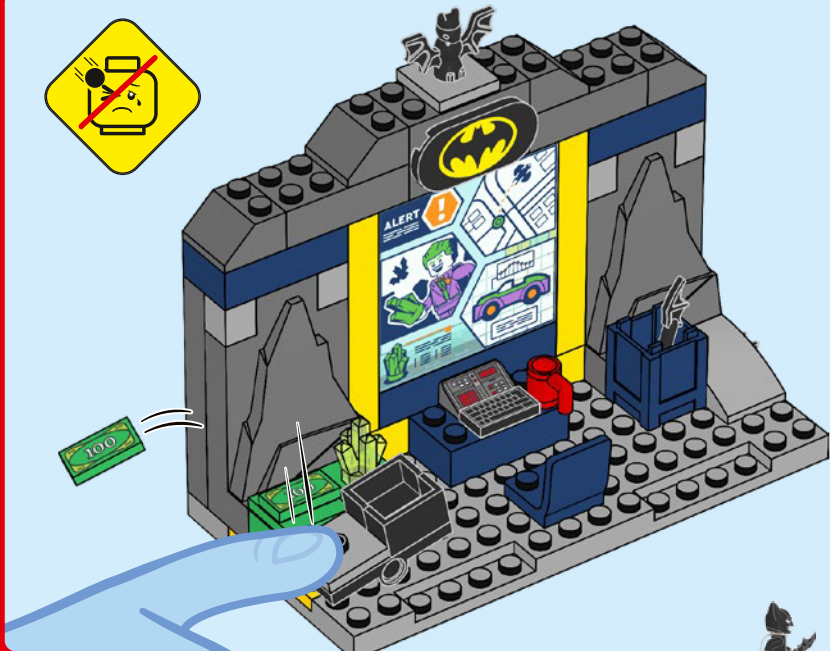







LEGO and the LEGO logo are trademarks of the LEGO Group. ©2024 The LEGO Group. 6522945  
BATMAN and all related characters and elements © & ™ DC (s24)



76272





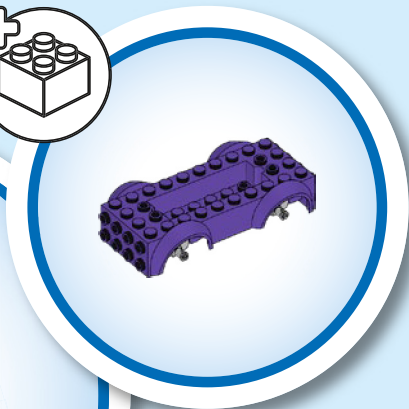

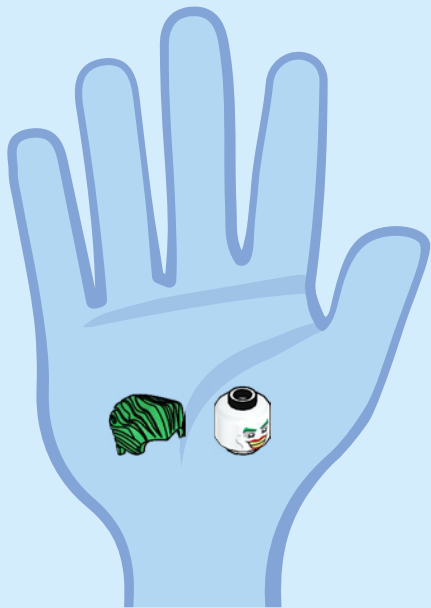
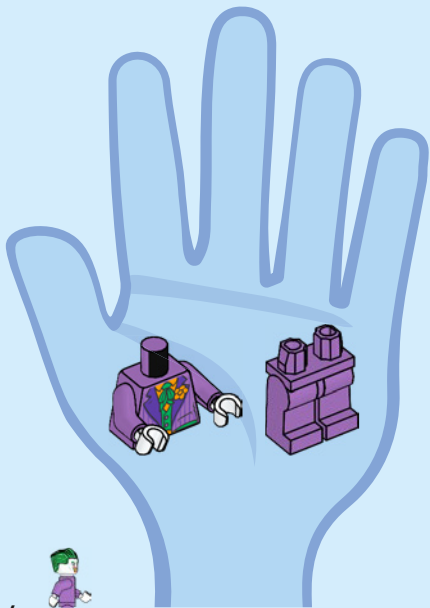



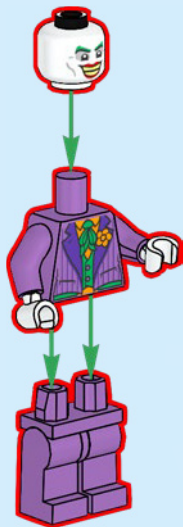

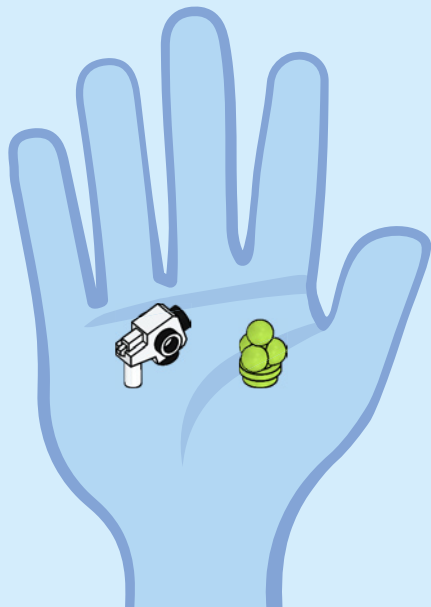

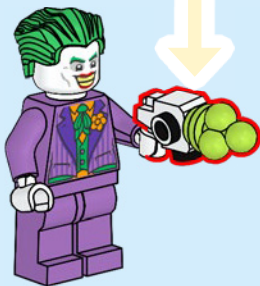
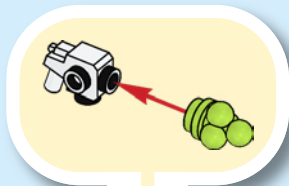

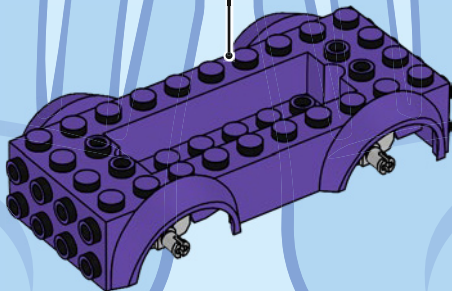
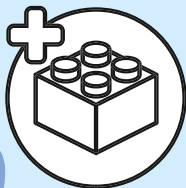

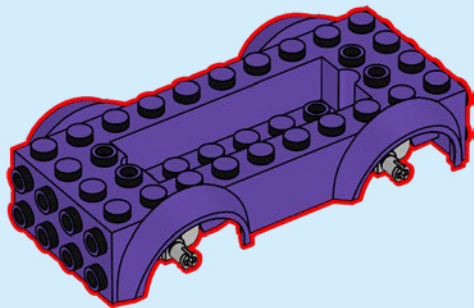



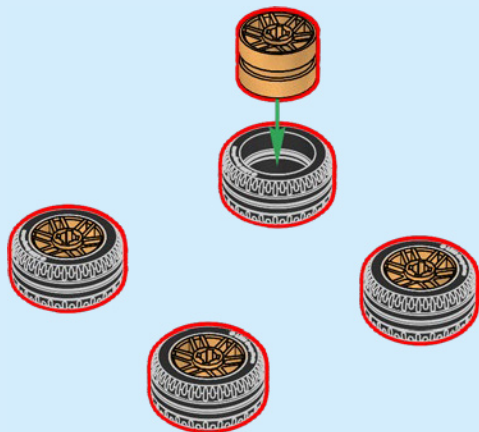





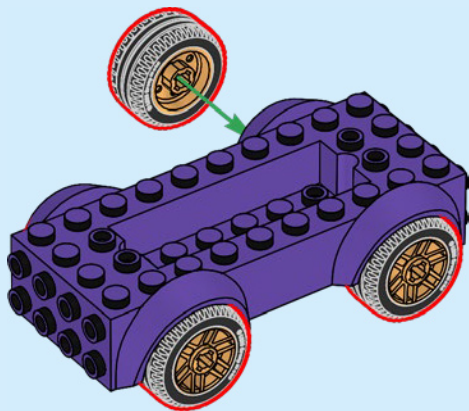

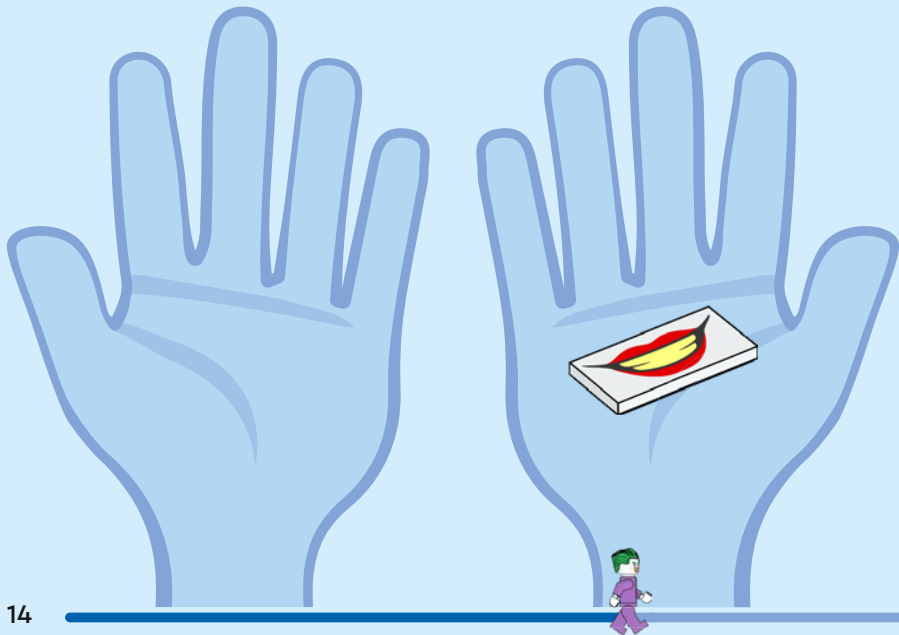

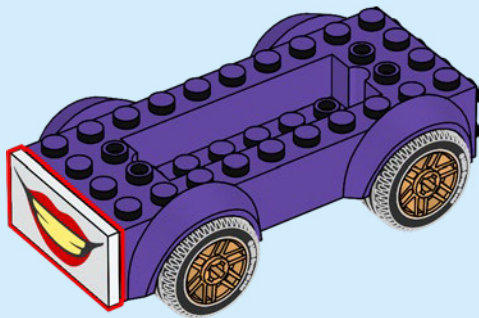

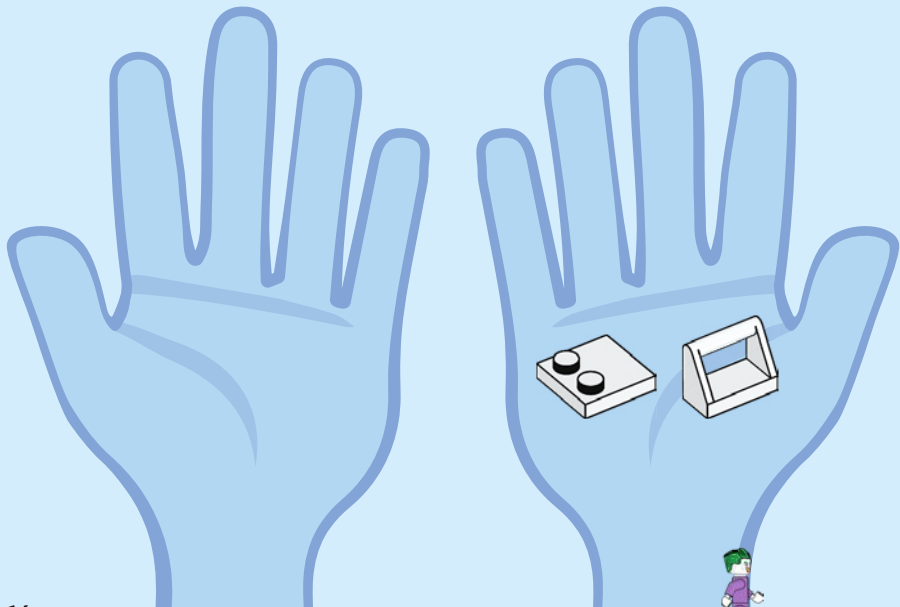

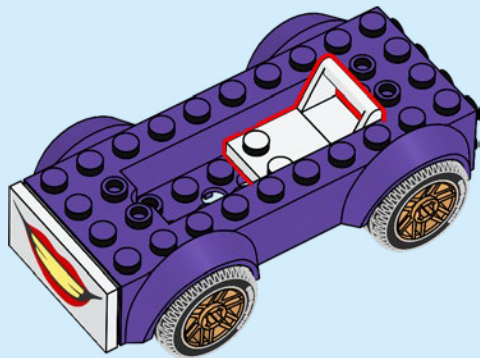

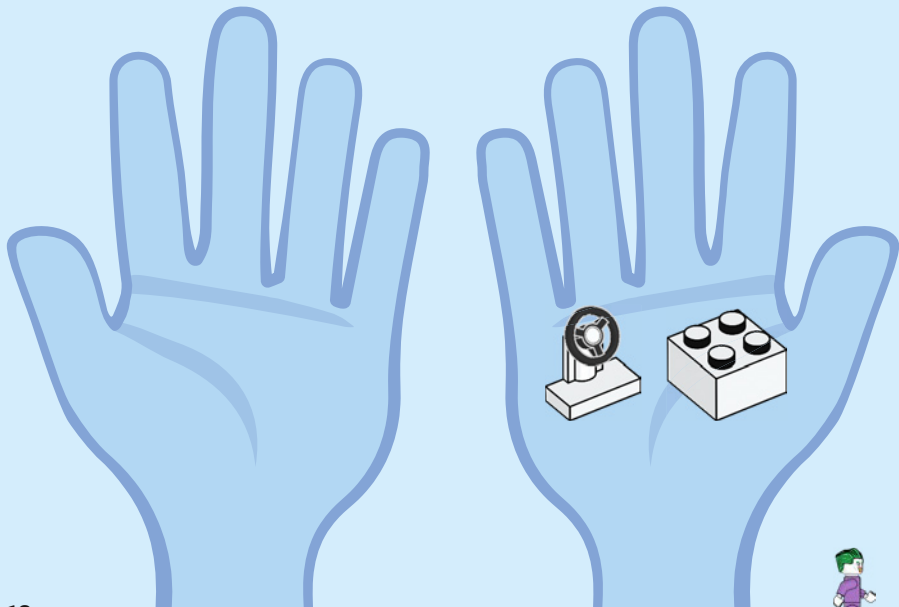

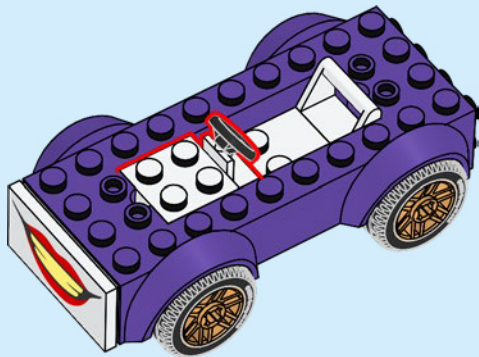

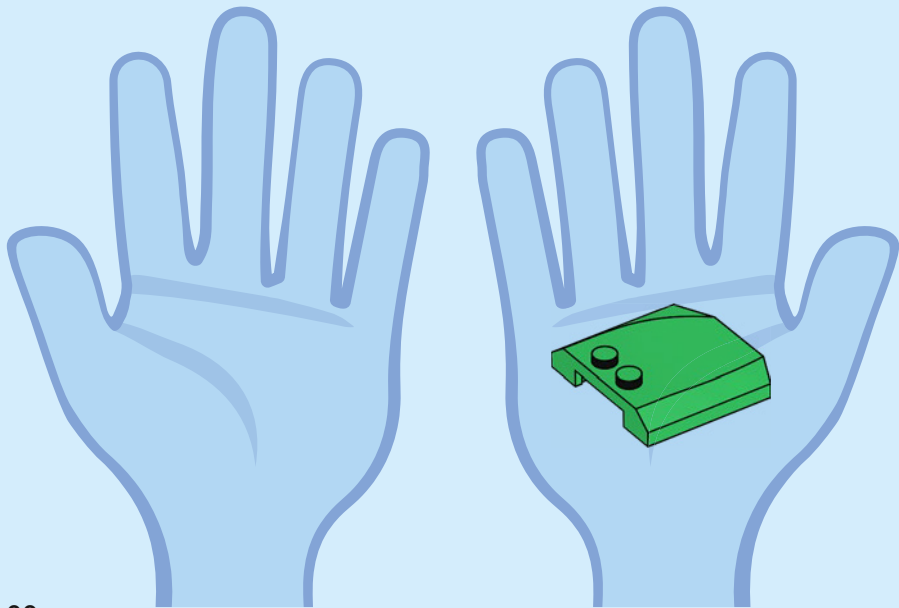



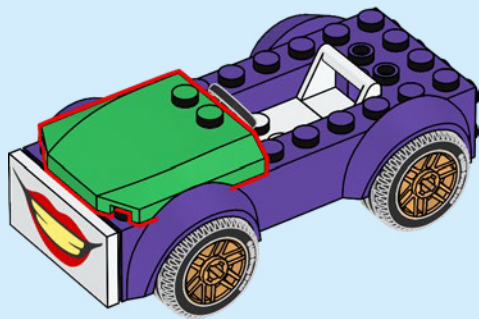

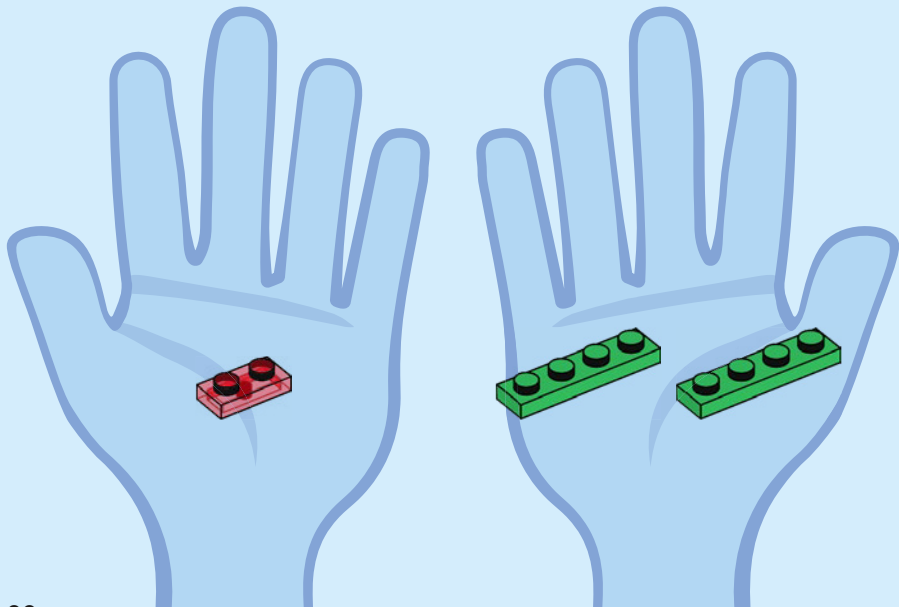

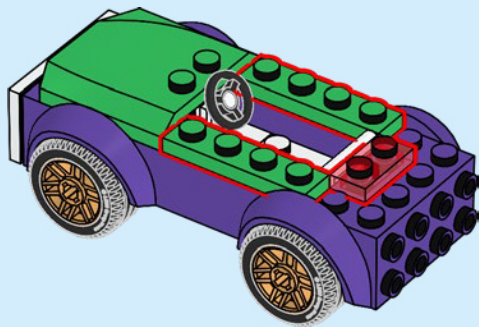

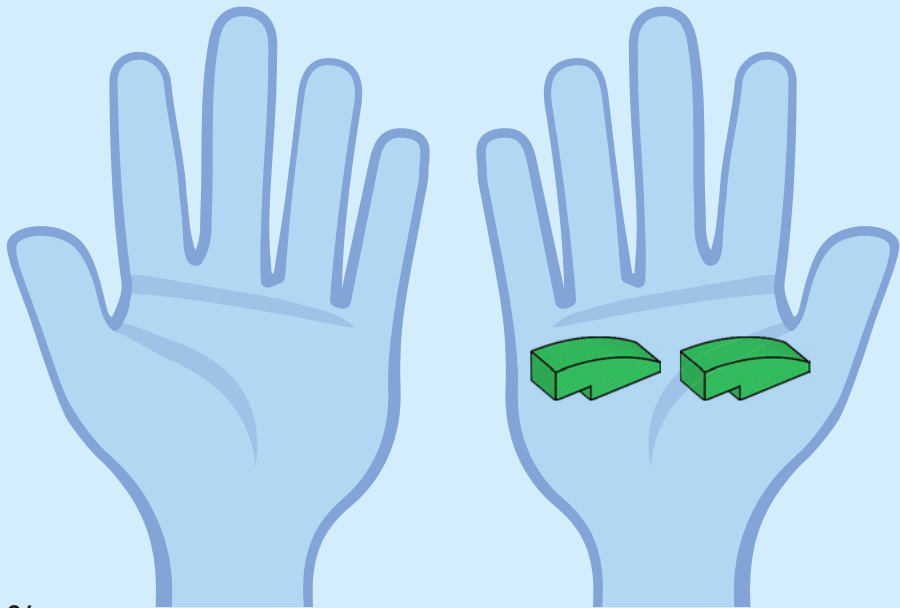

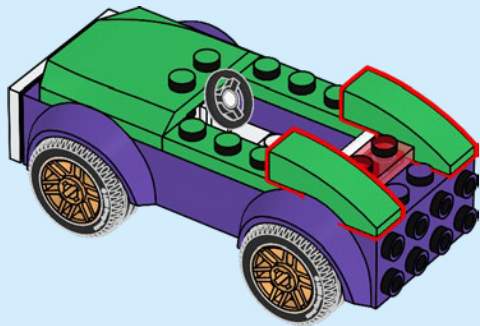

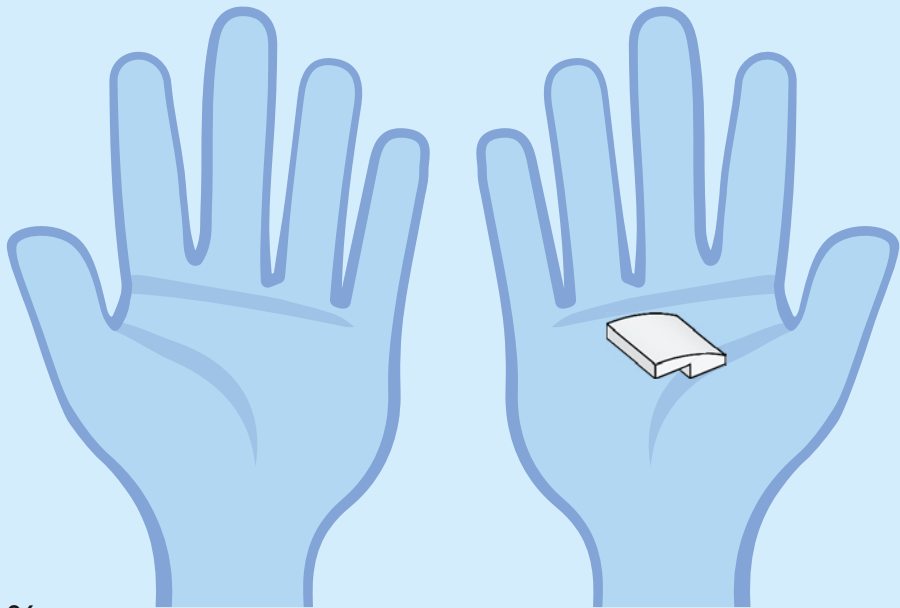

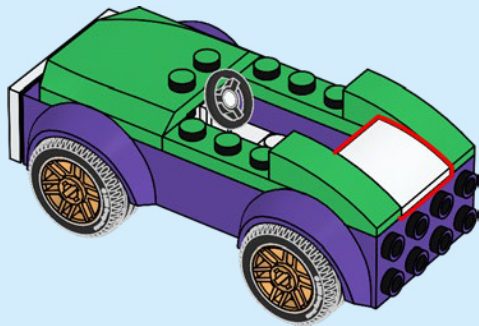

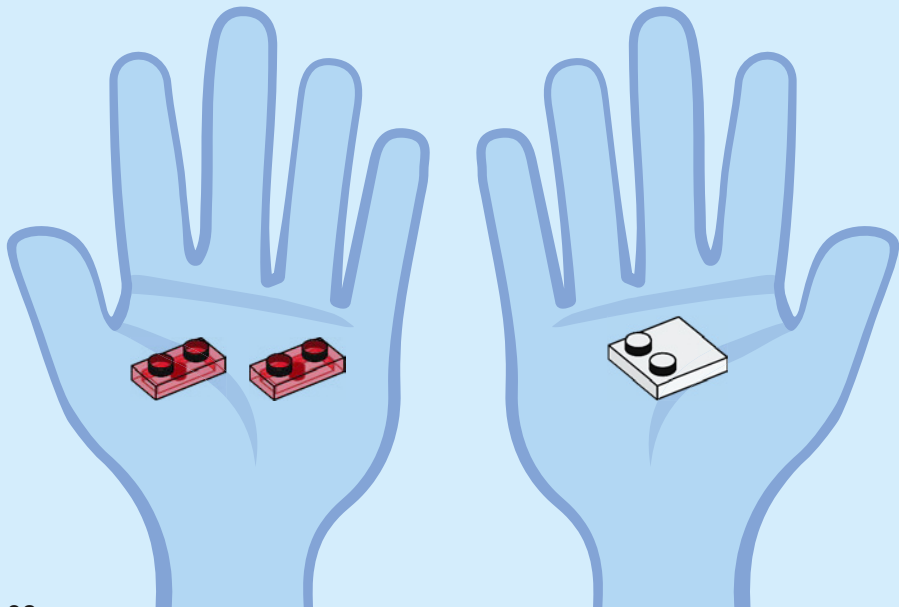



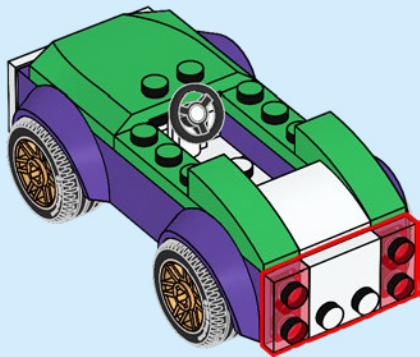

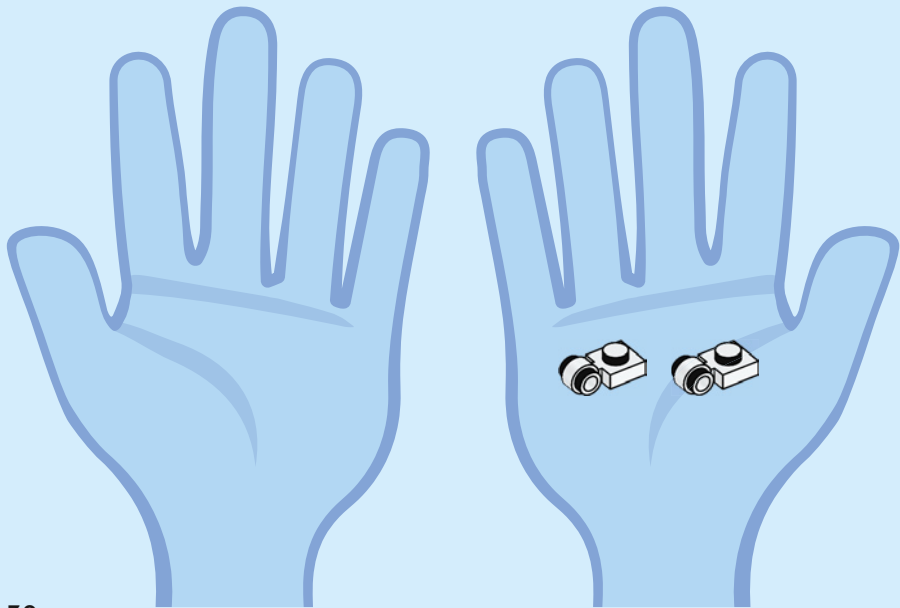

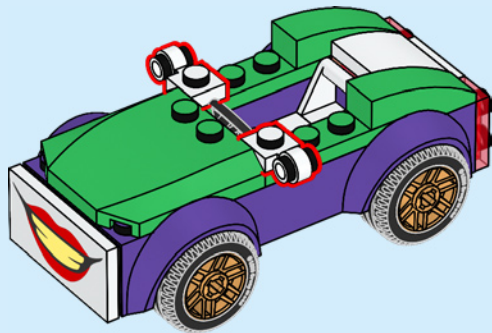

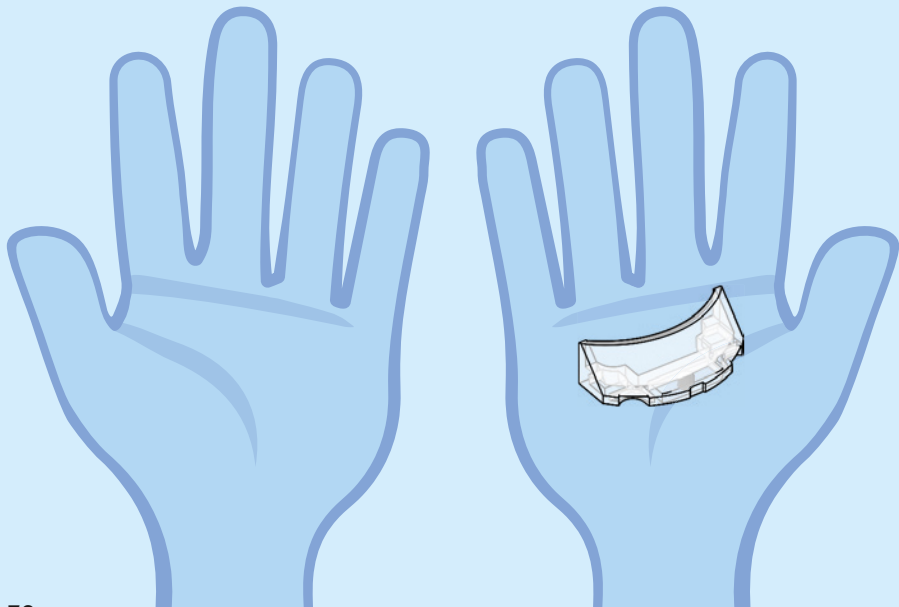

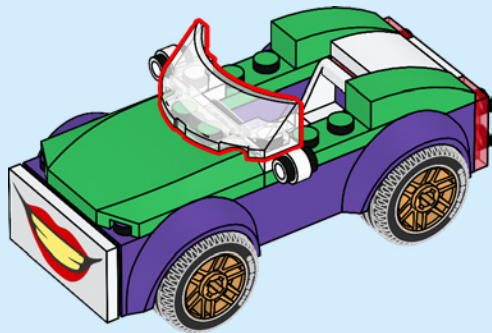

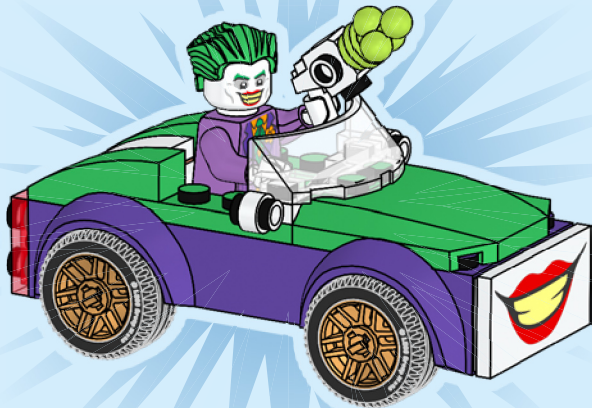





LEGO and the LEGO logo are trademarks of the LEGO Group. ©2024 The LEGO Group. 6522947  
BATMAN and all related characters and elements © & ™ DC (s24)





76272





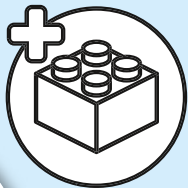

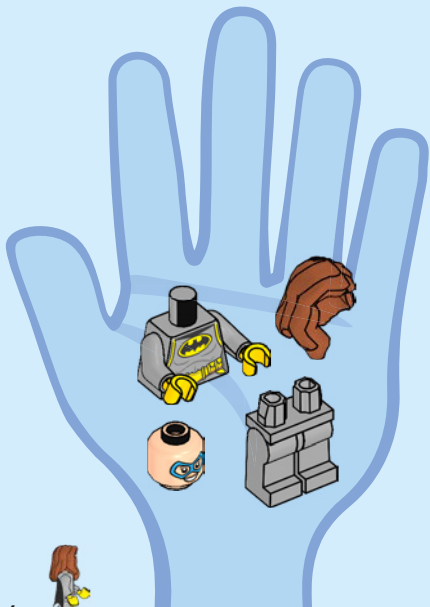

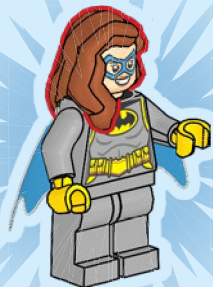
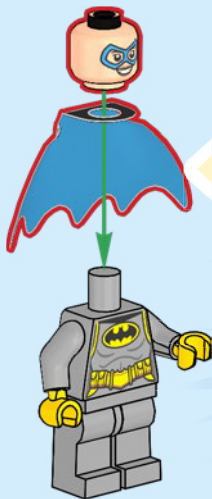
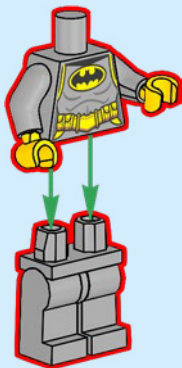



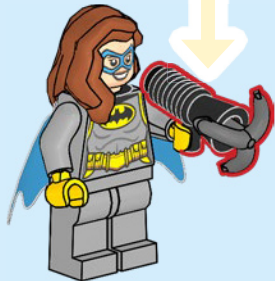
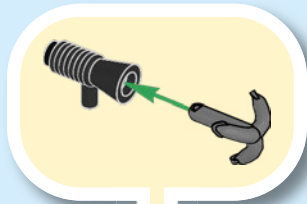

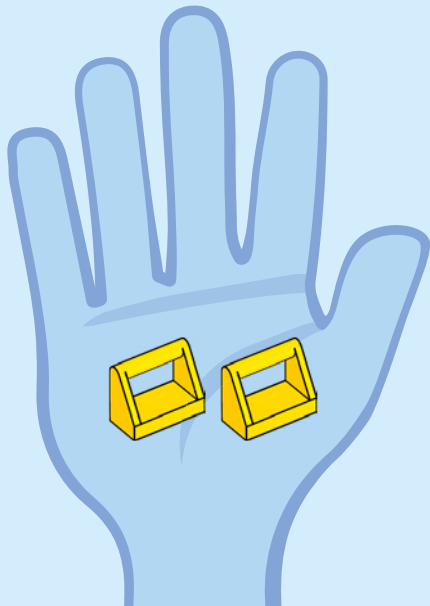
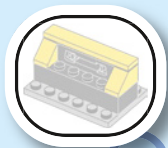



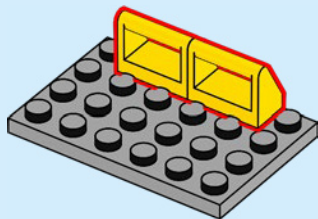
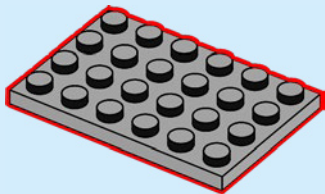

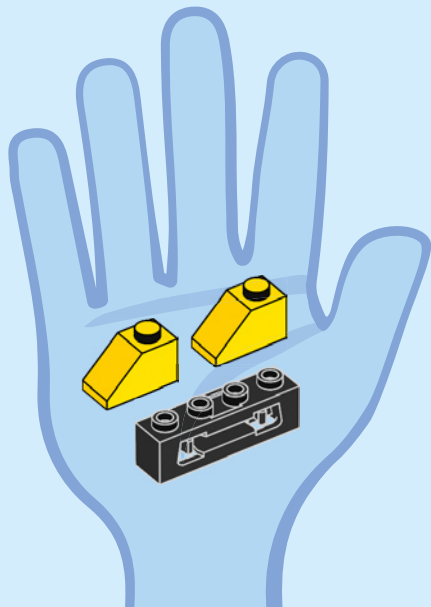
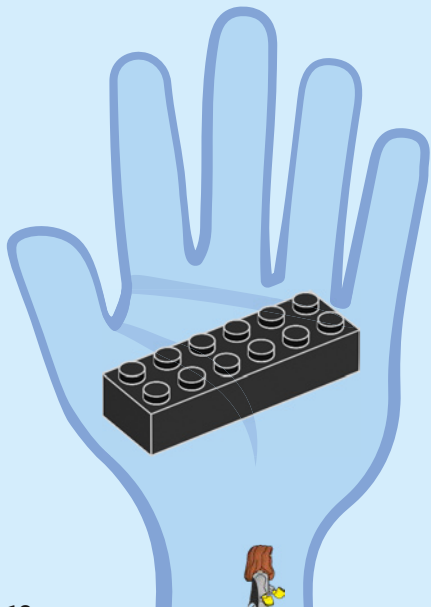

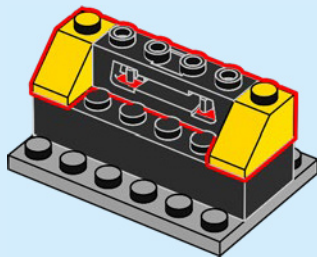
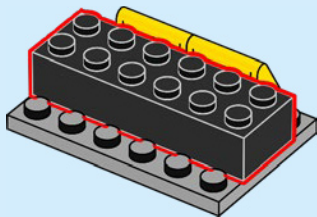

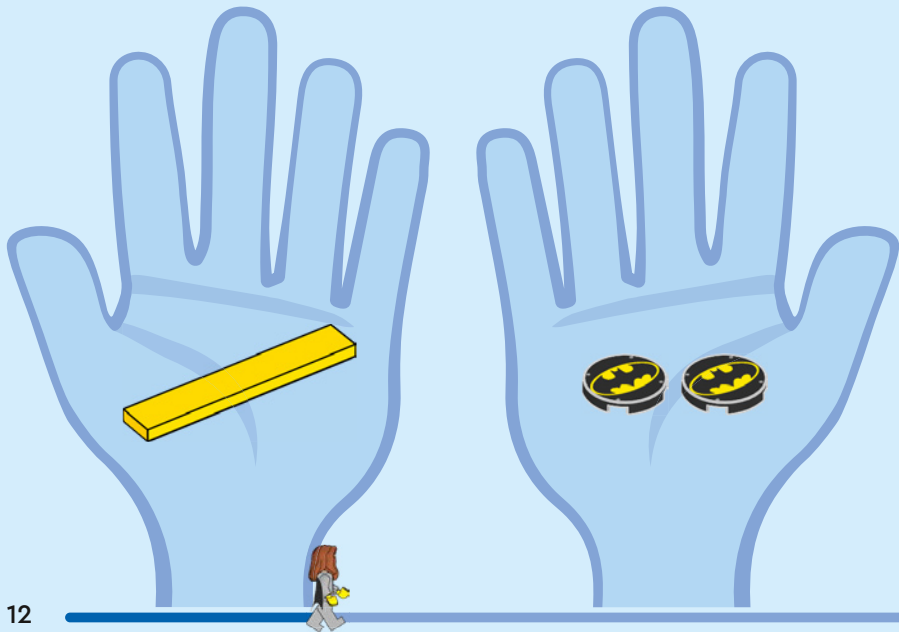

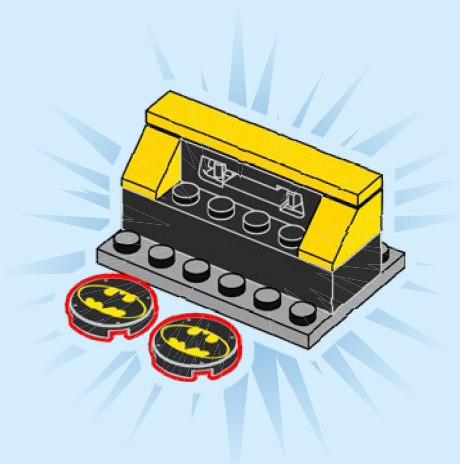
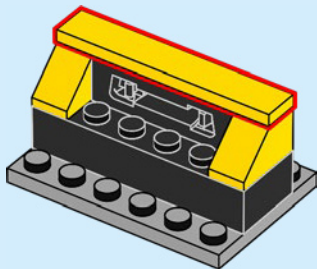

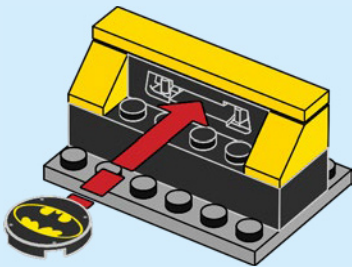

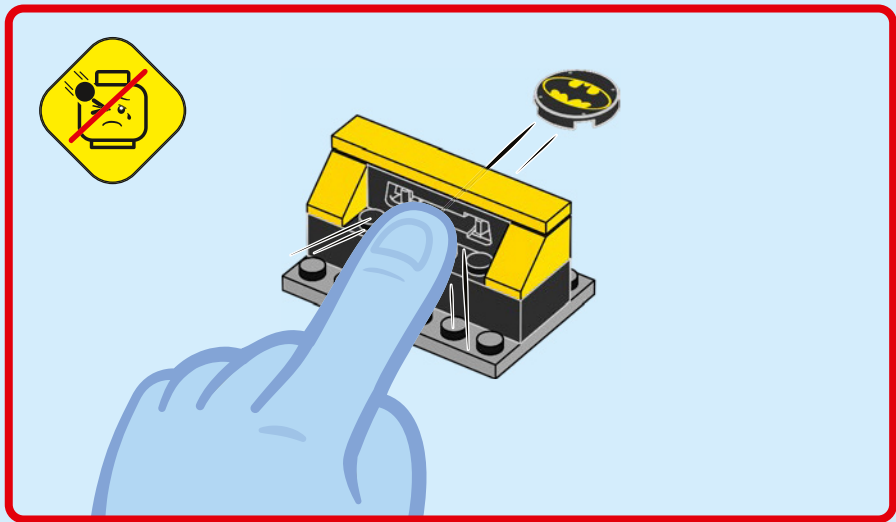

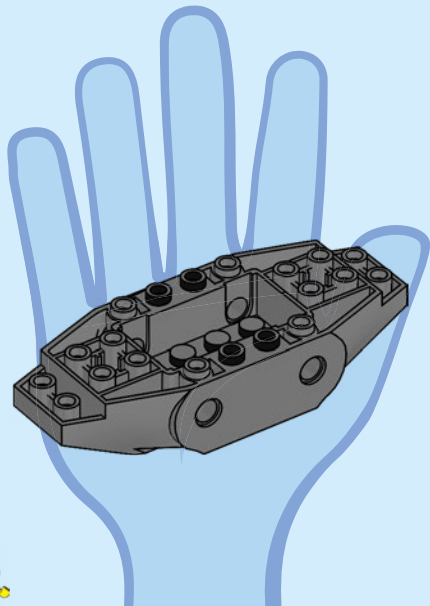
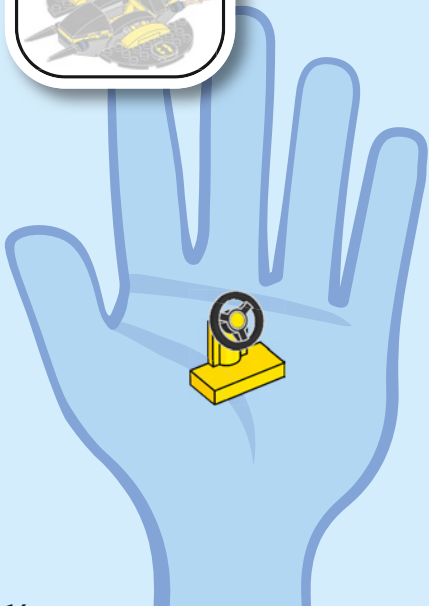



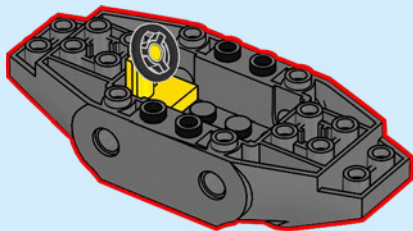

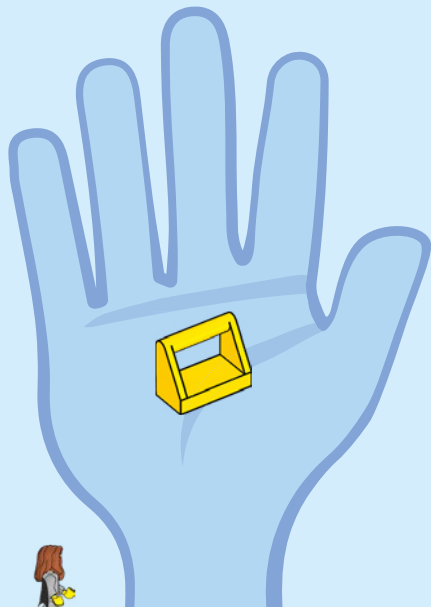
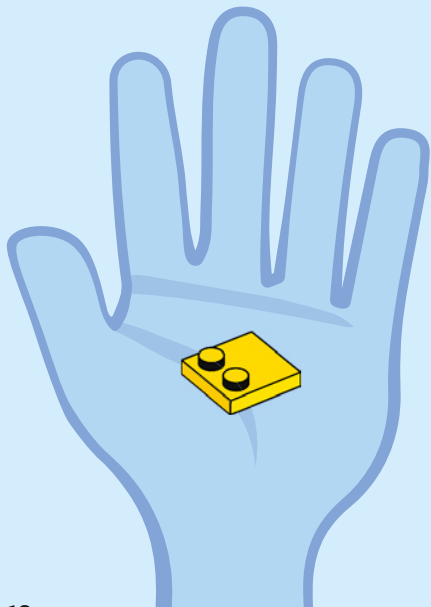

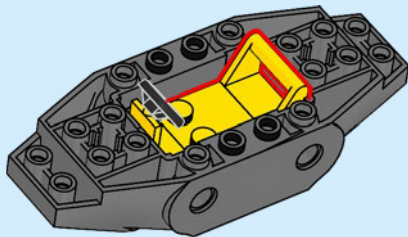

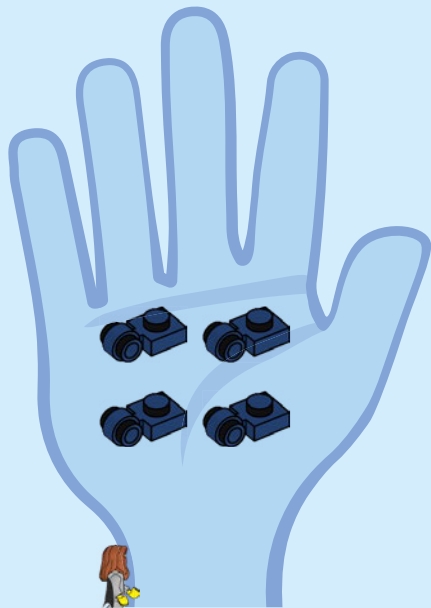

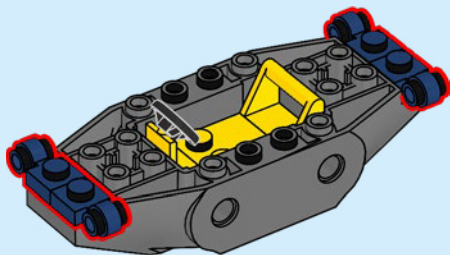

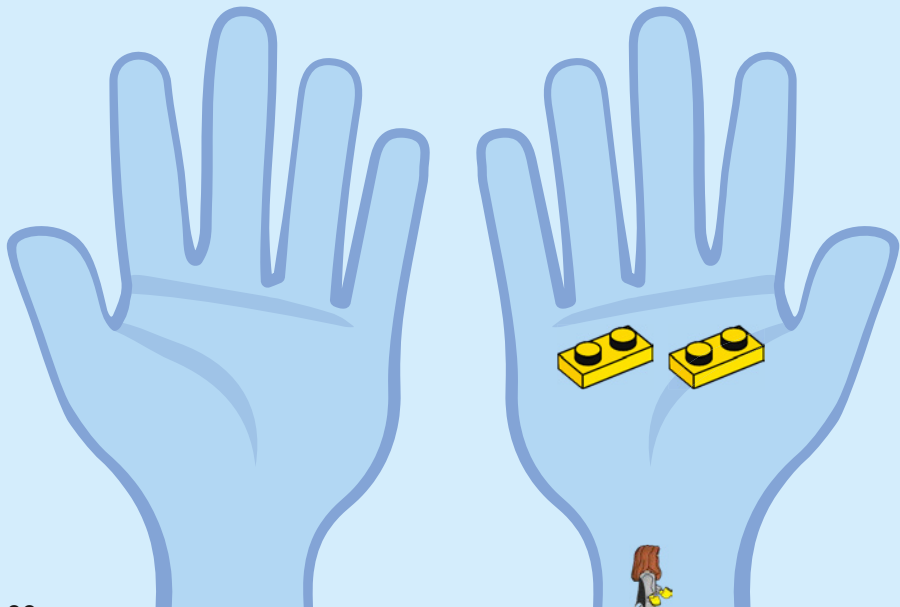

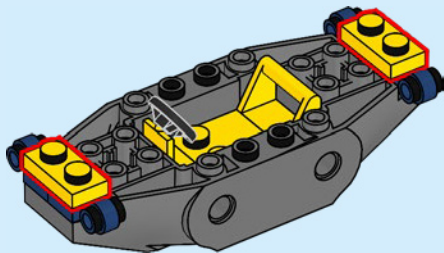

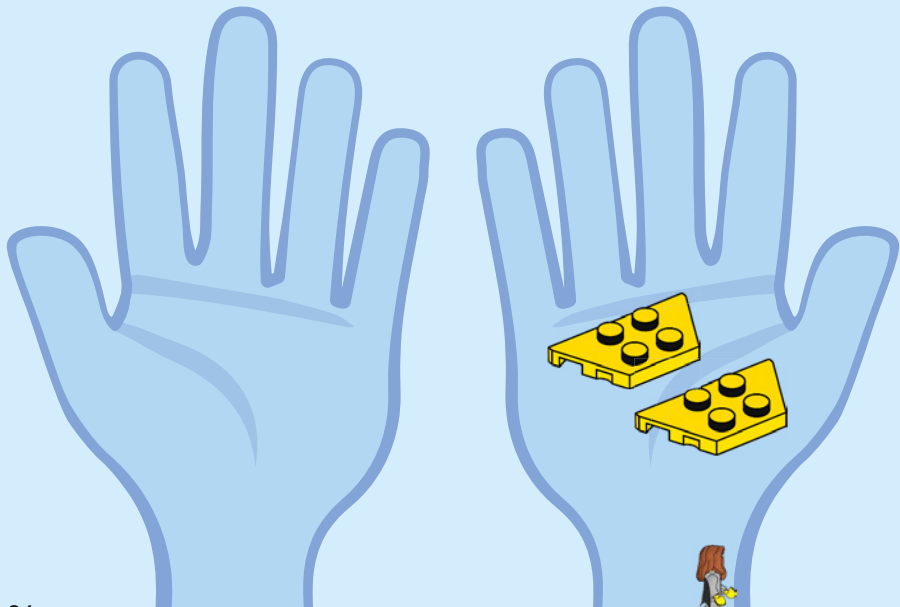



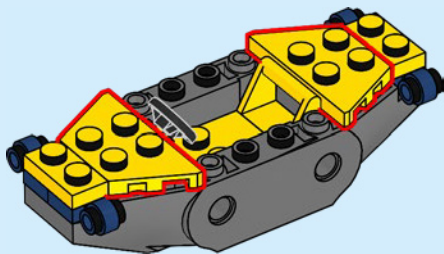

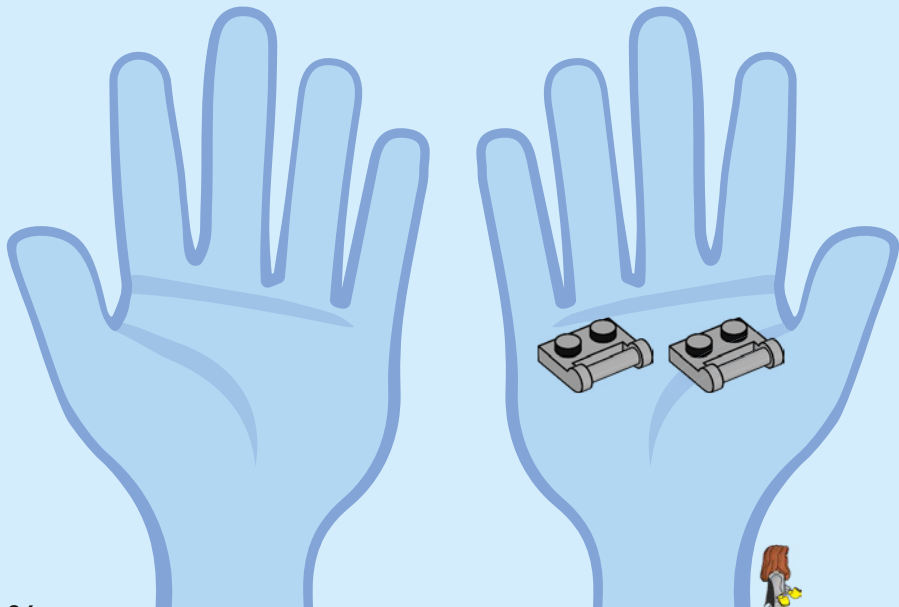

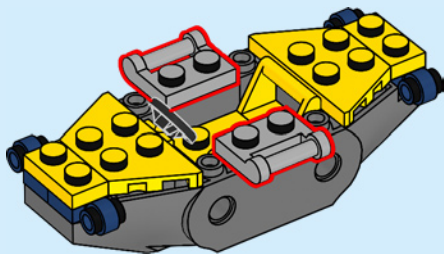



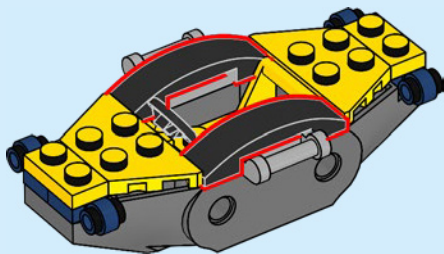

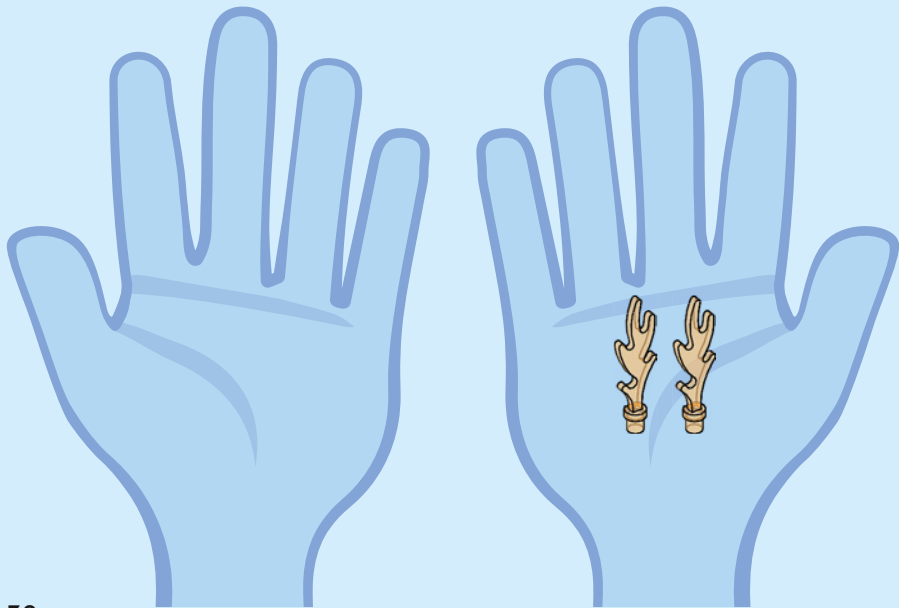

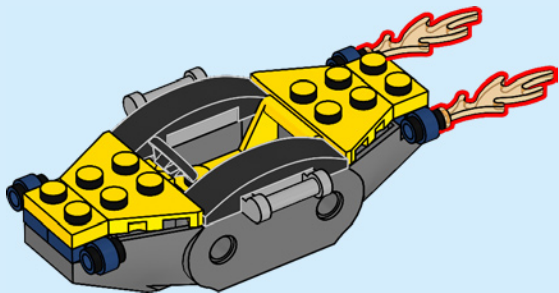

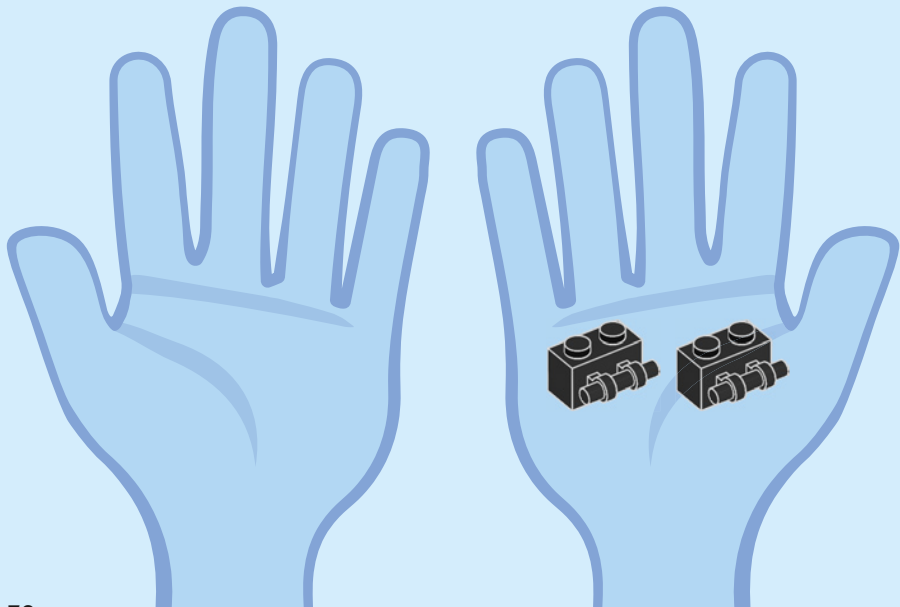



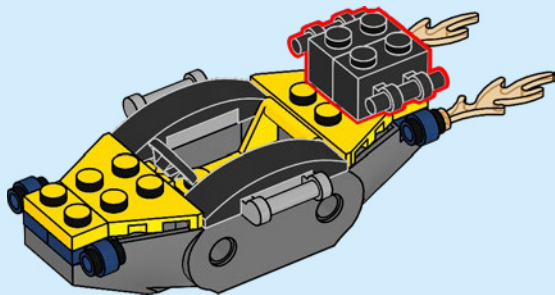

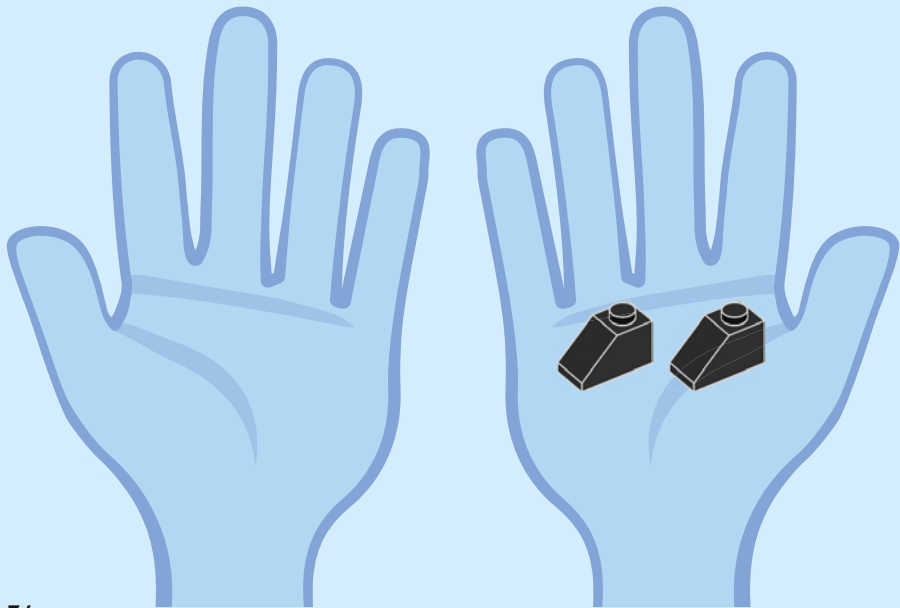

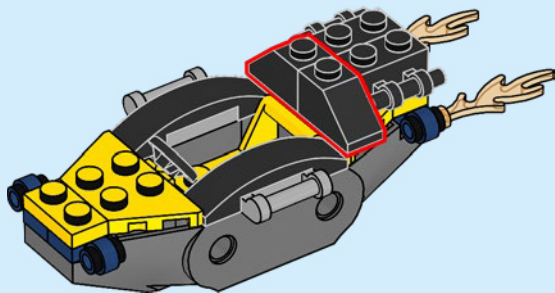

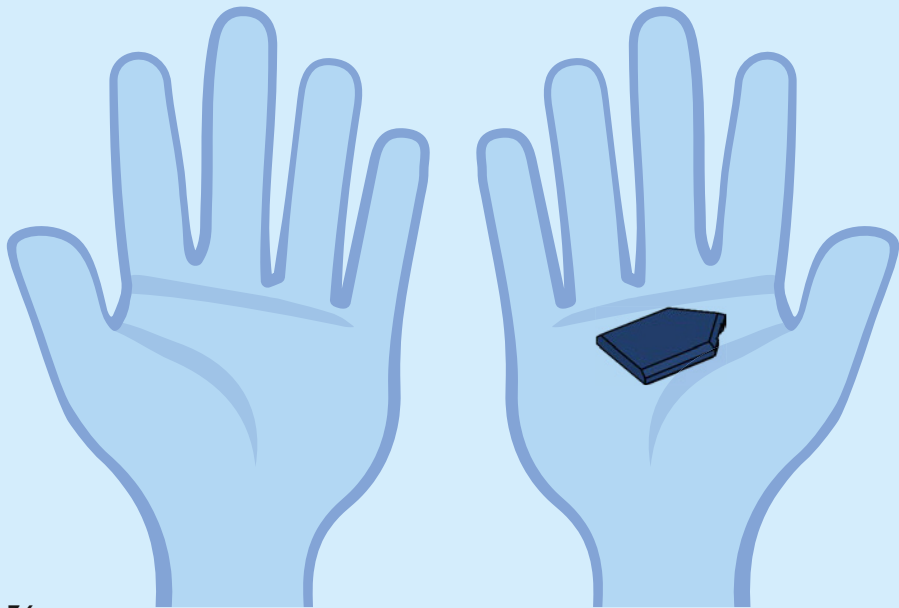

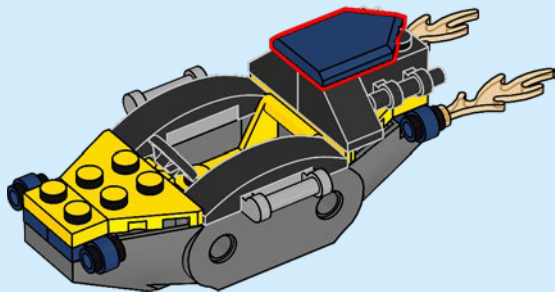

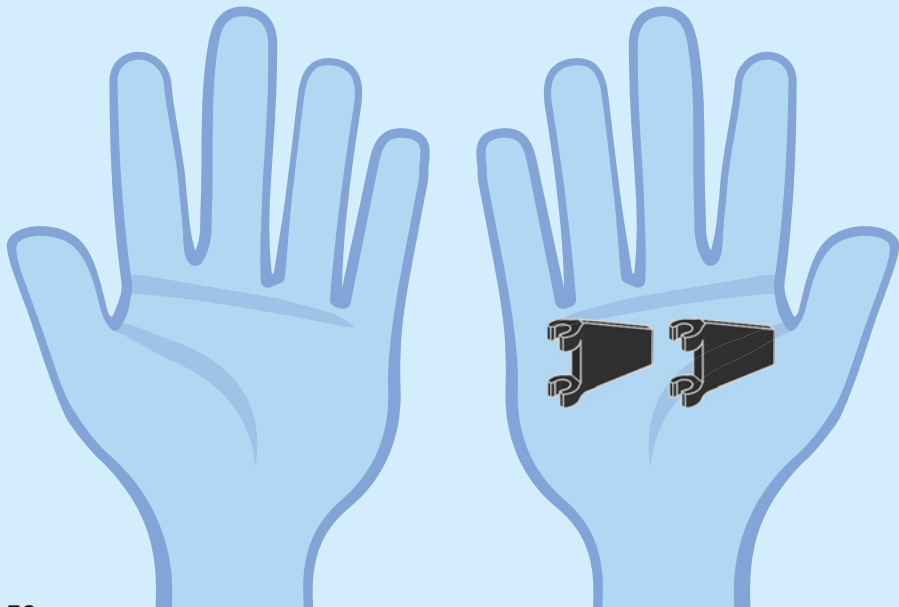

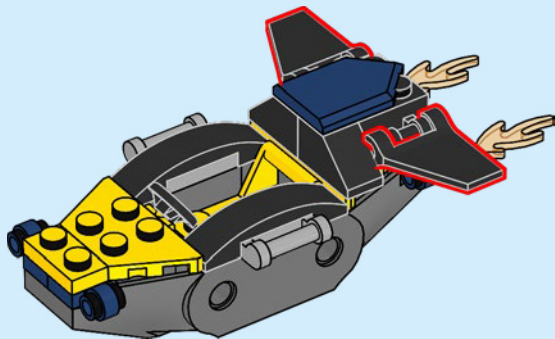

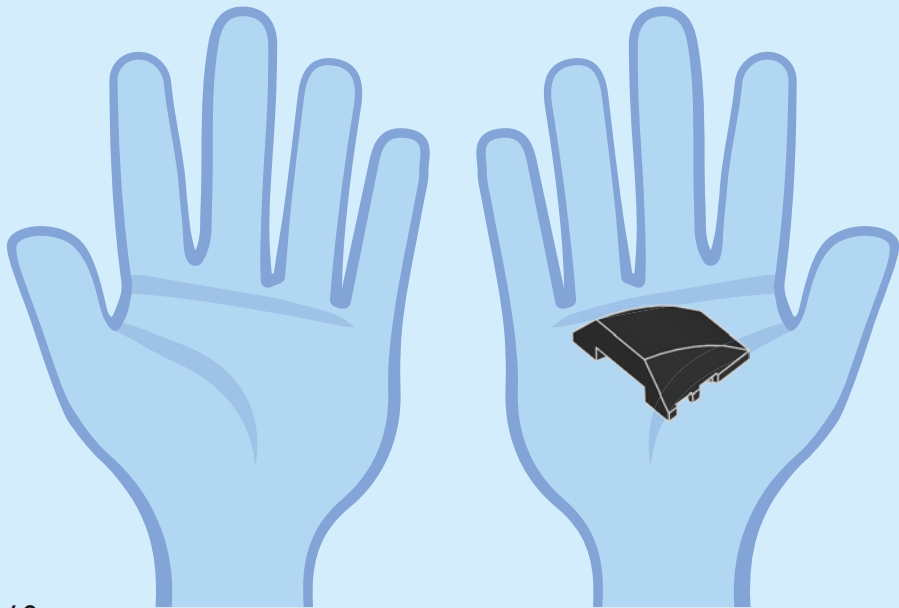



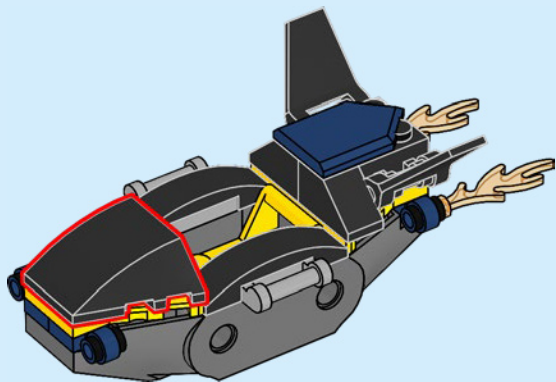

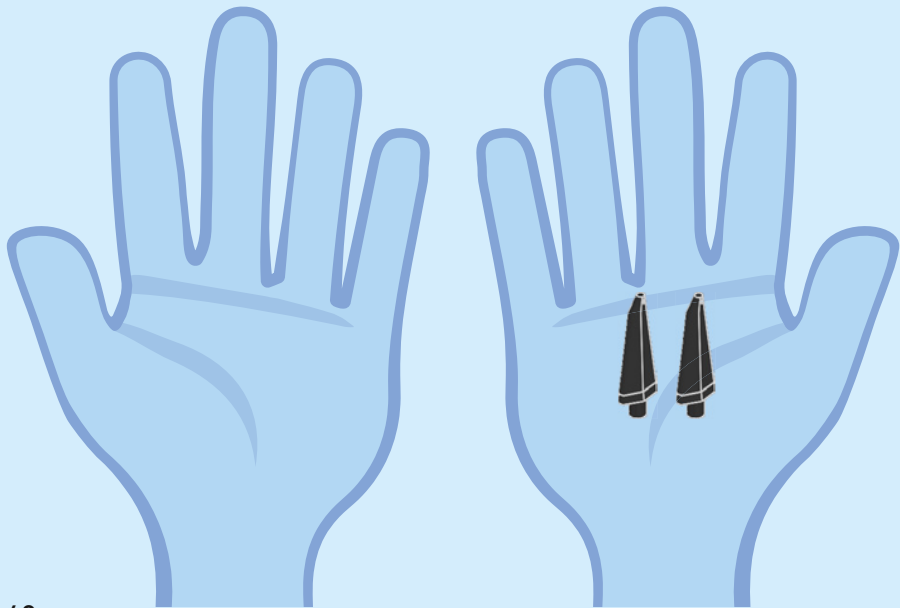

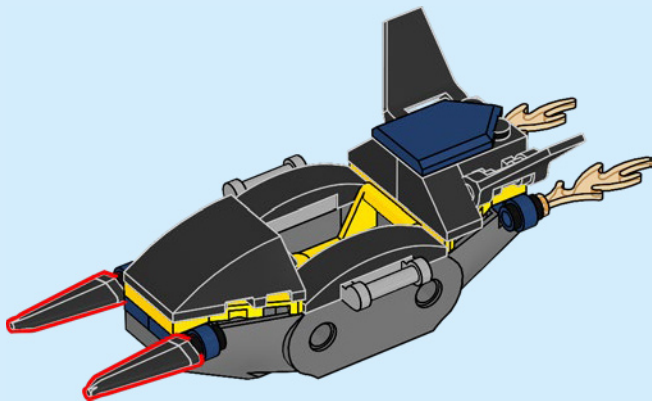

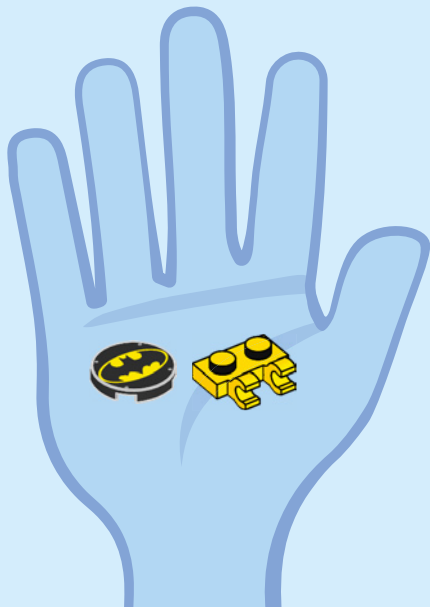

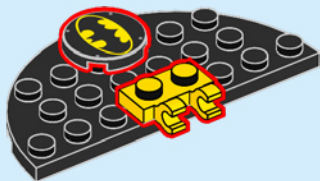
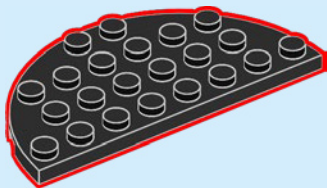

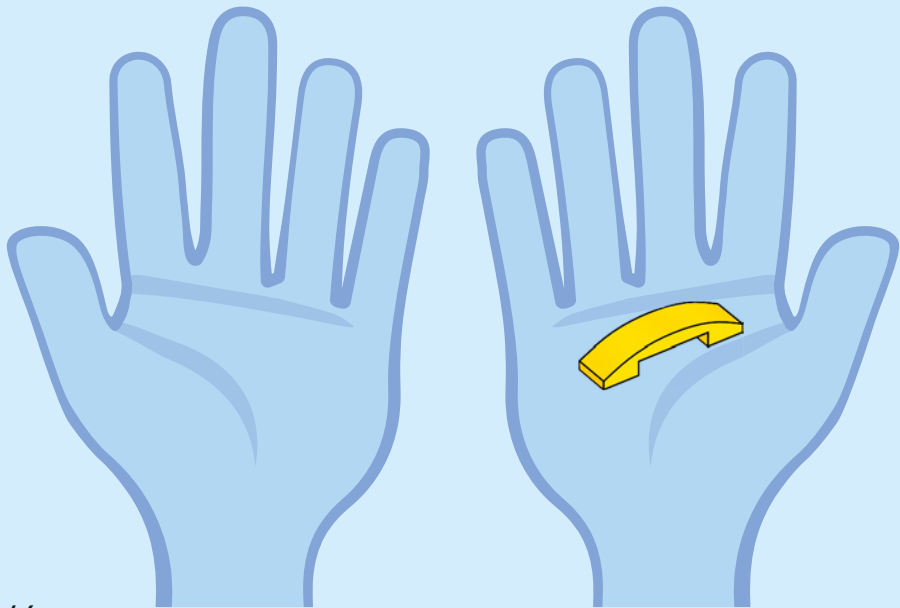

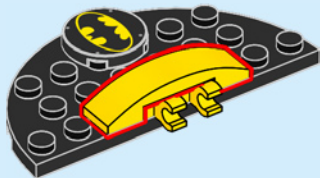

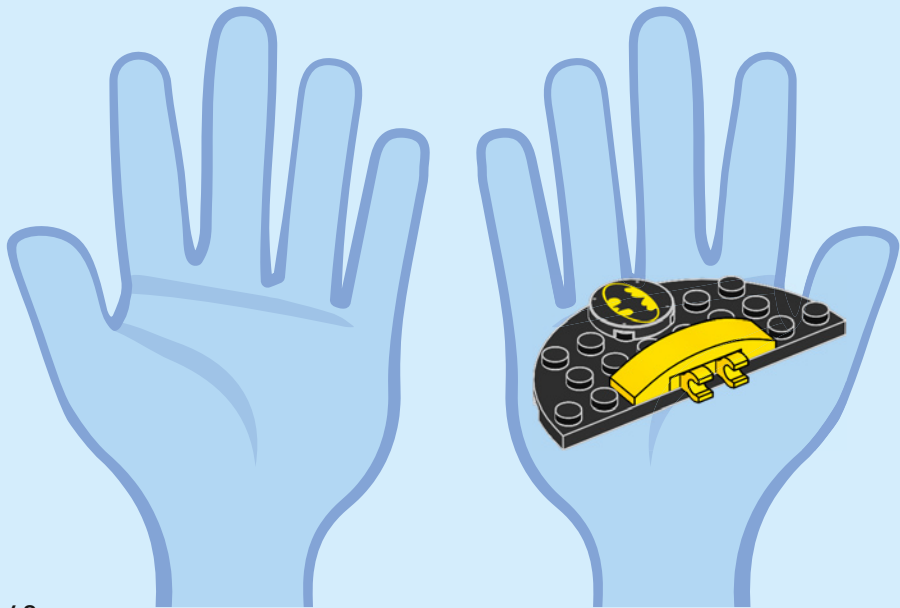



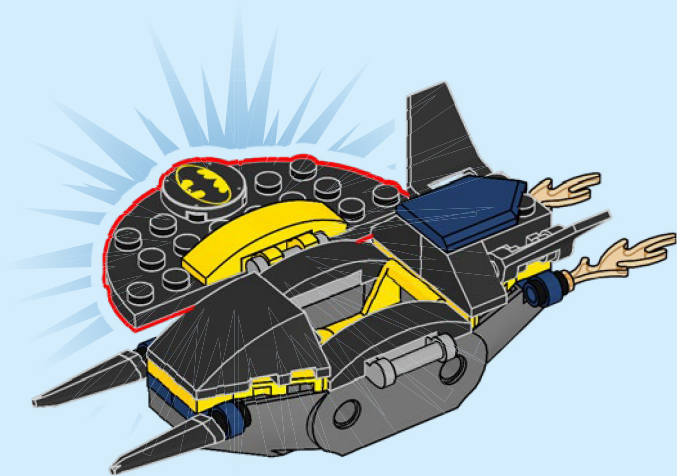

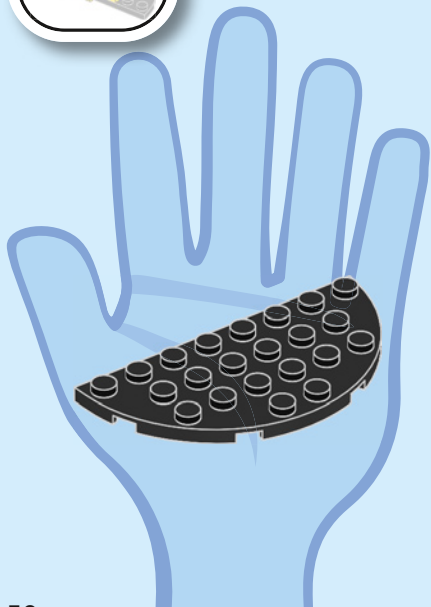

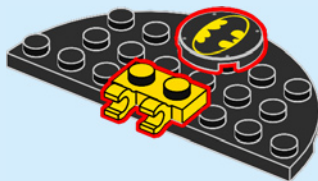
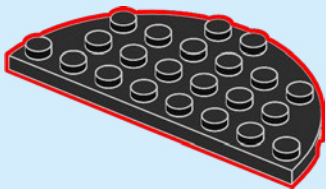

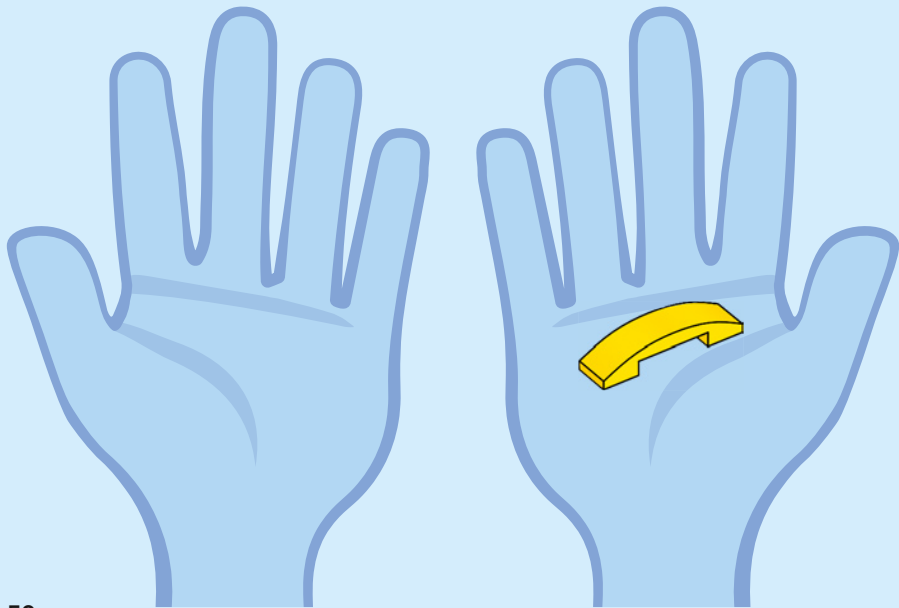

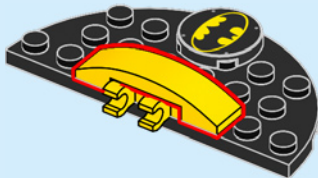

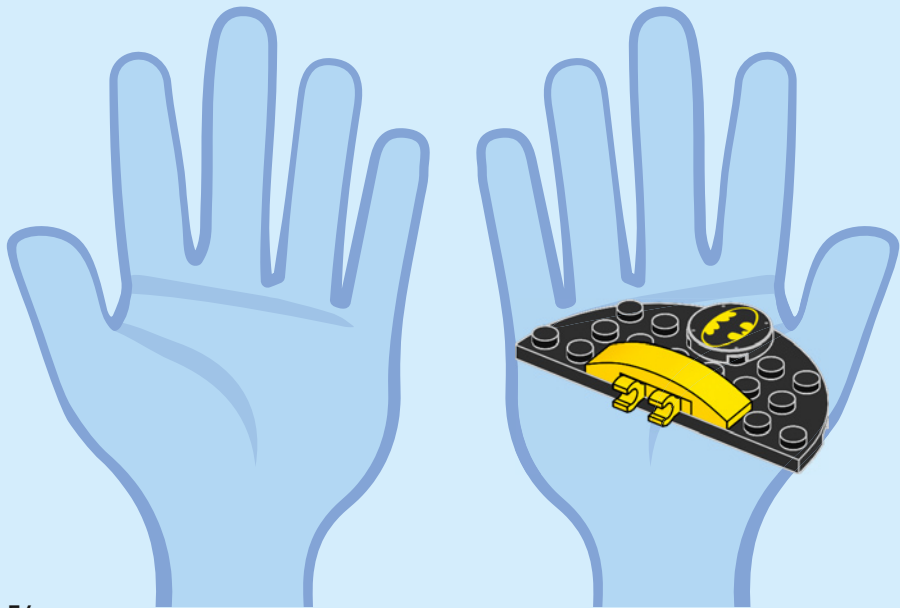

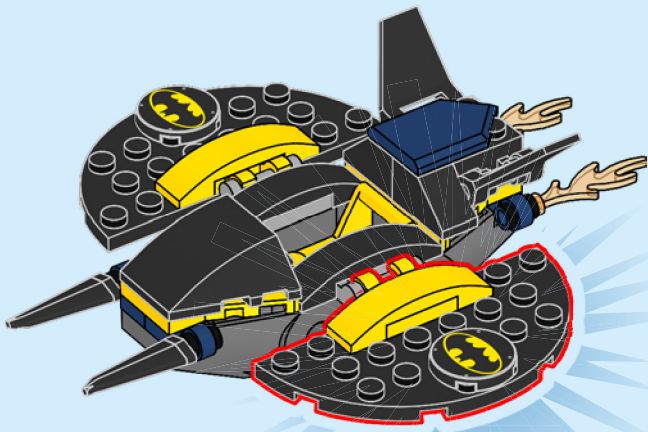

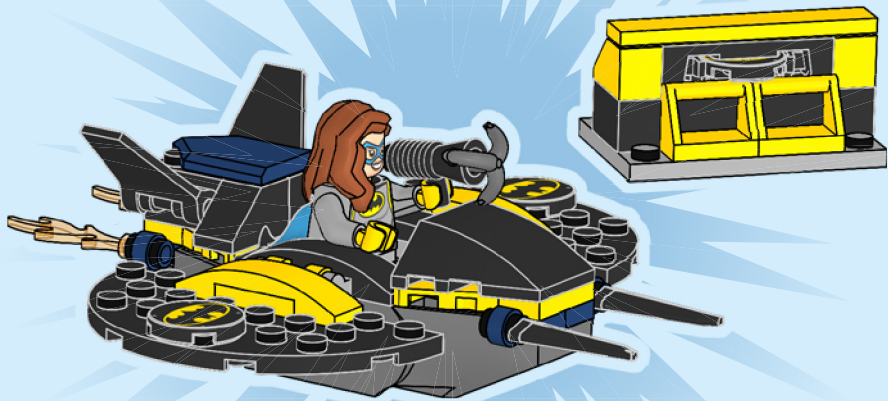







Rebuild  
the  
world™





Rebuild  
the  
world™





LEGO and the LEGO logo are trademarks of the LEGO Group. ©2024 The LEGO Group. 6522949  
BATMAN and all related characters and elements © & ™ DC (s24)



76272







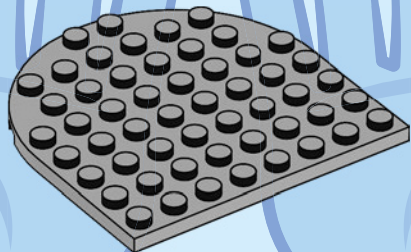
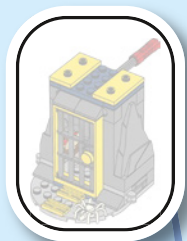



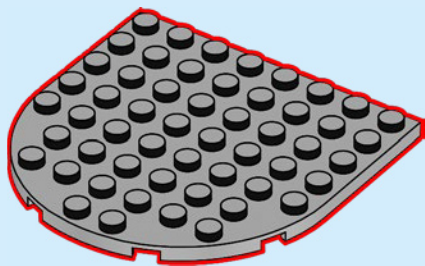

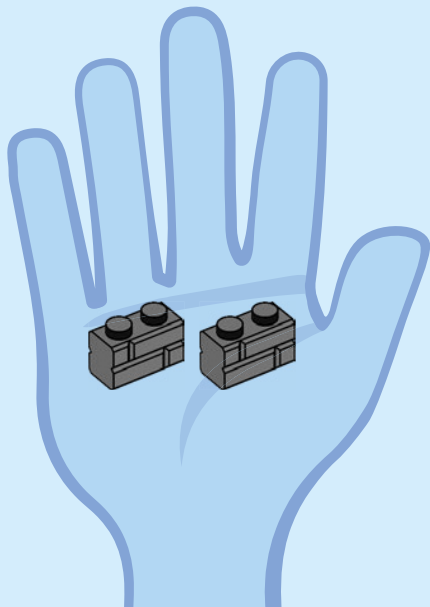

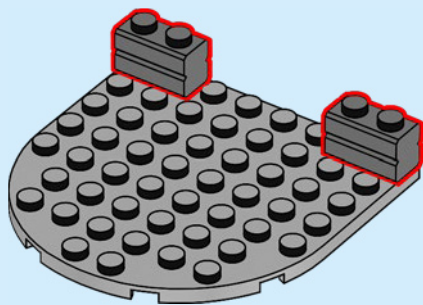

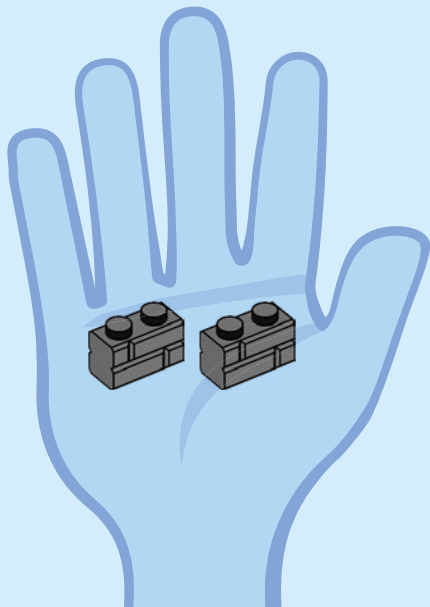
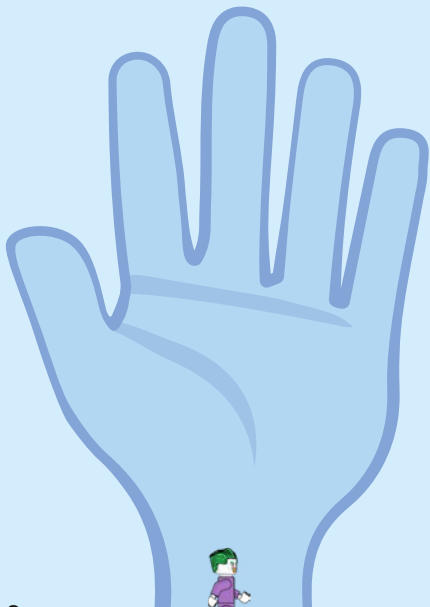

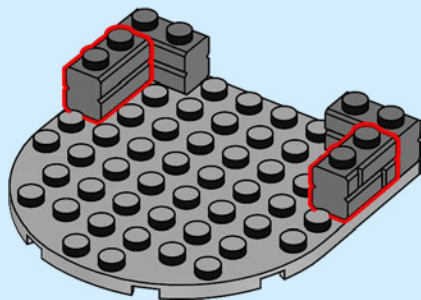

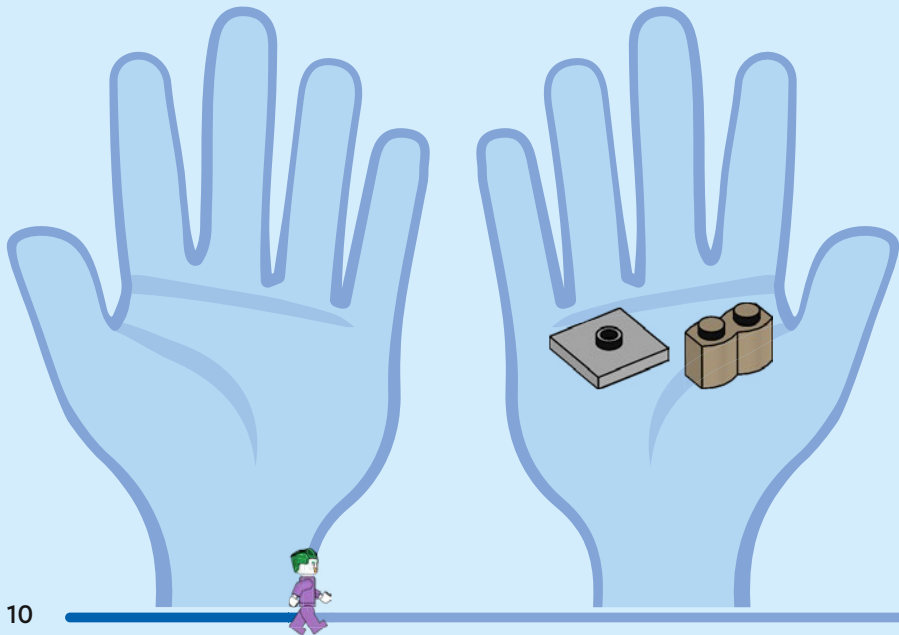

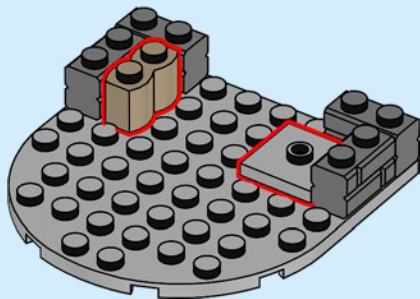





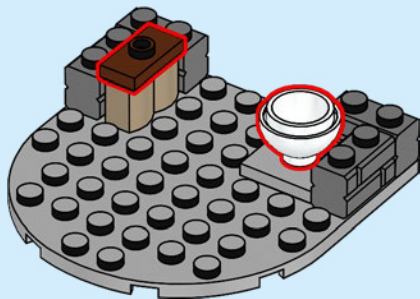



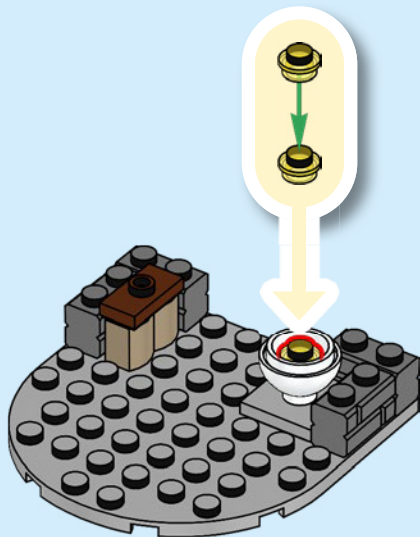

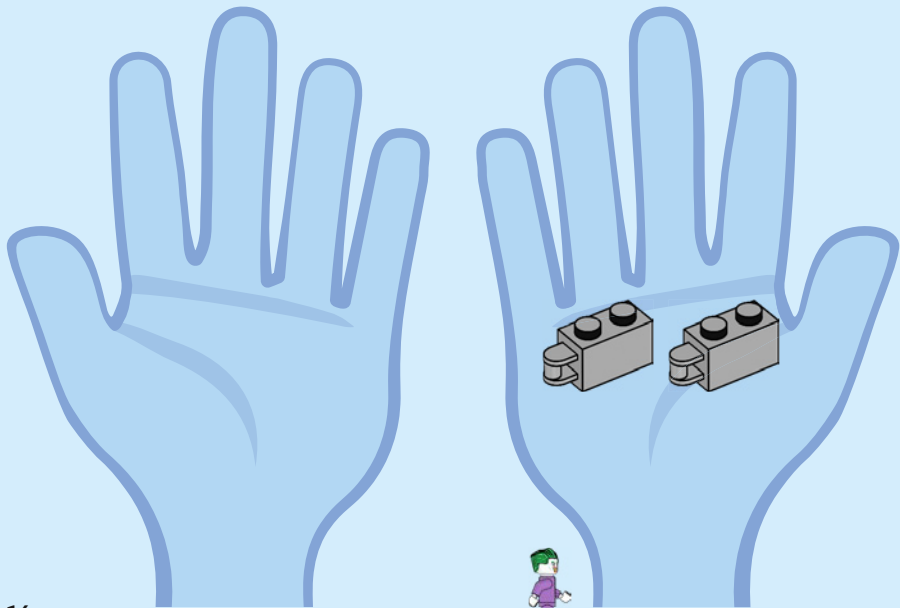

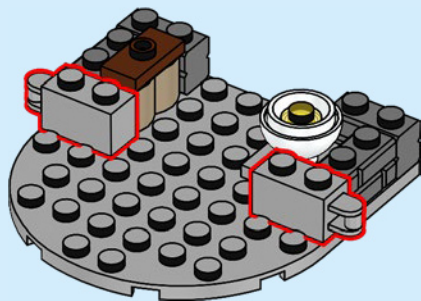

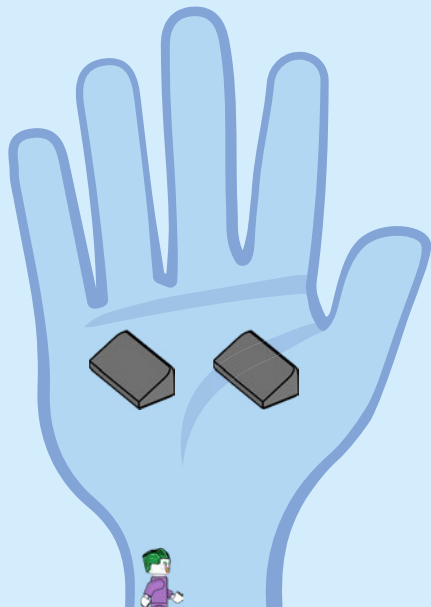
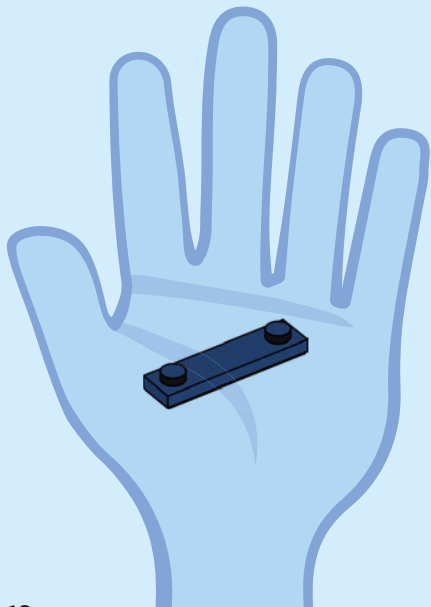

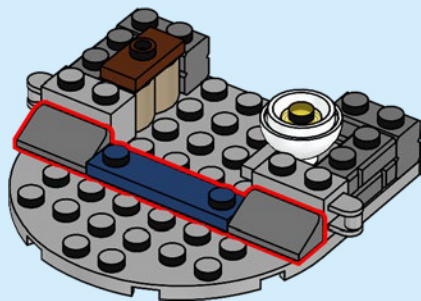

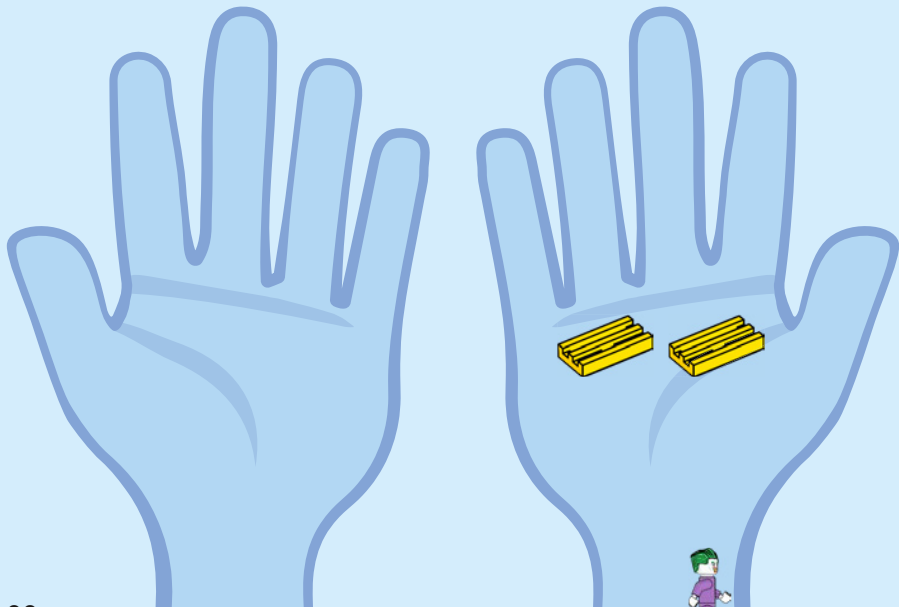



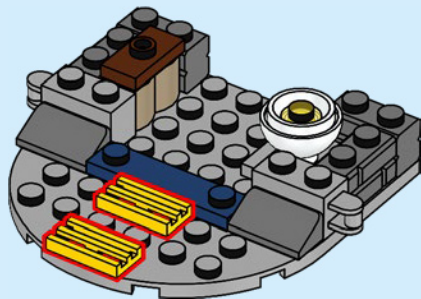

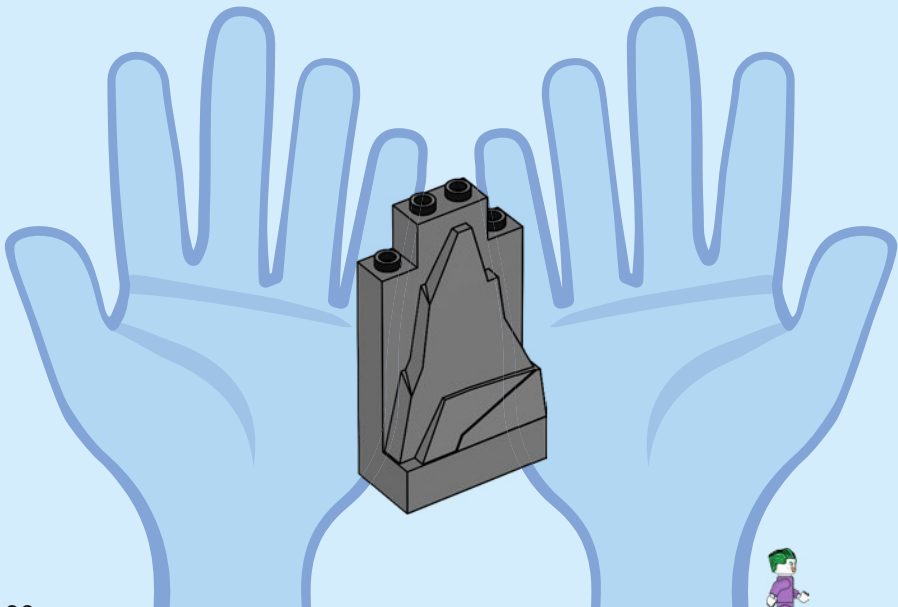

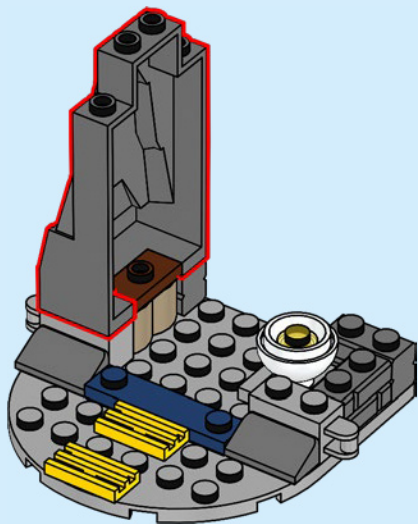

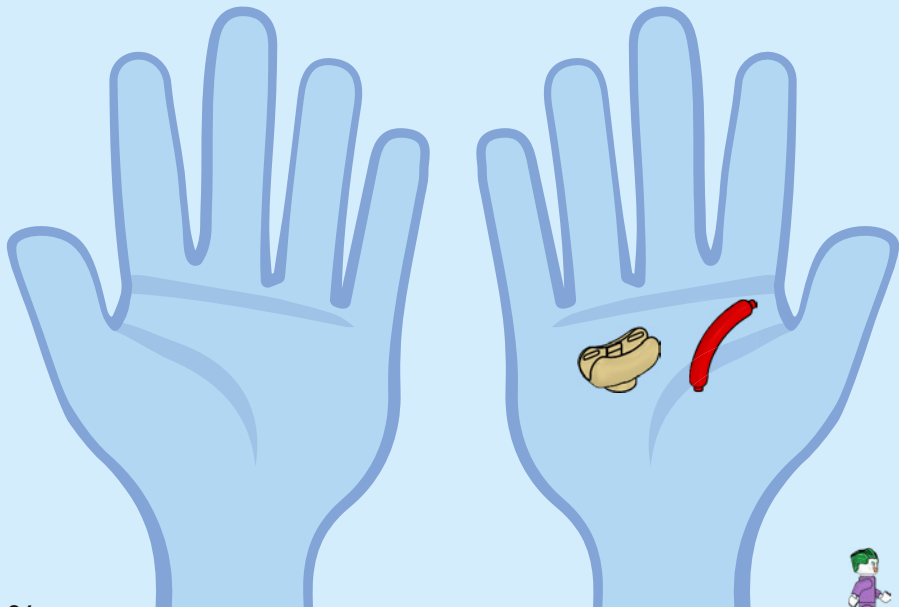

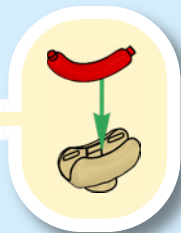
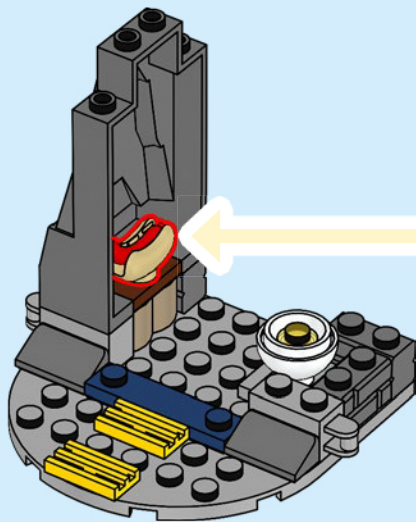

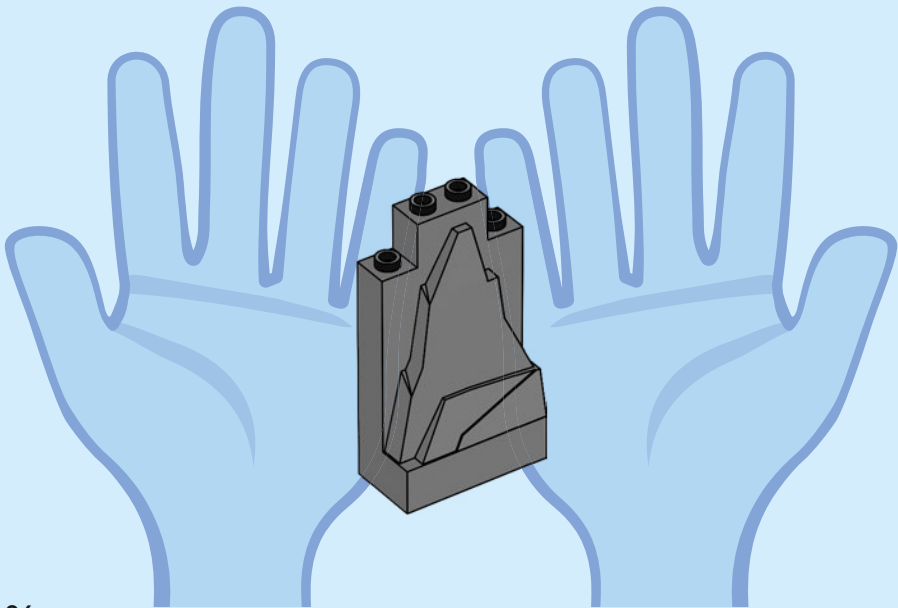

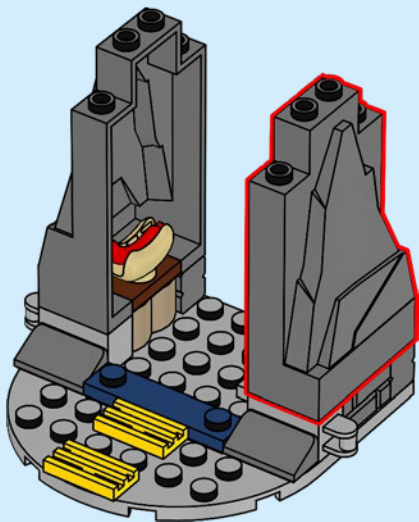

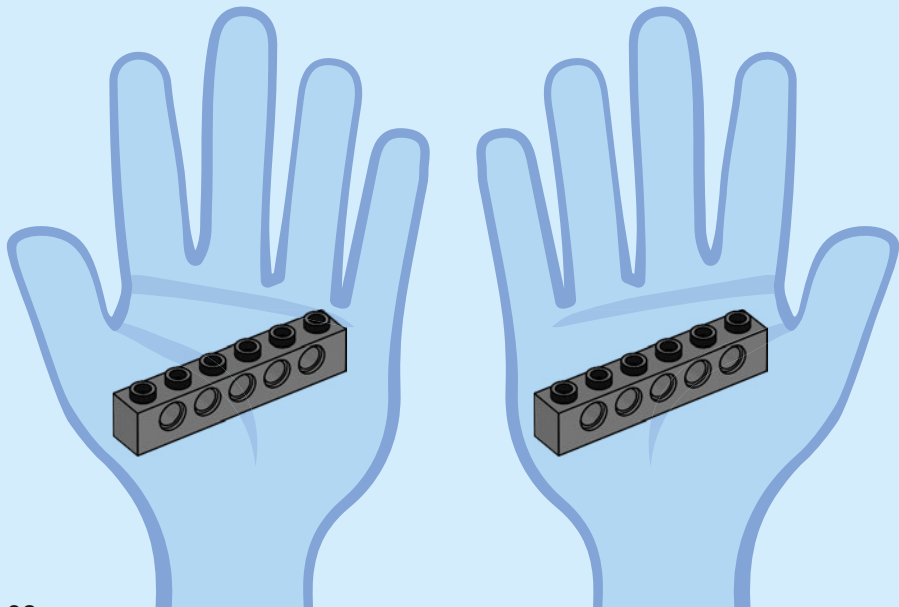



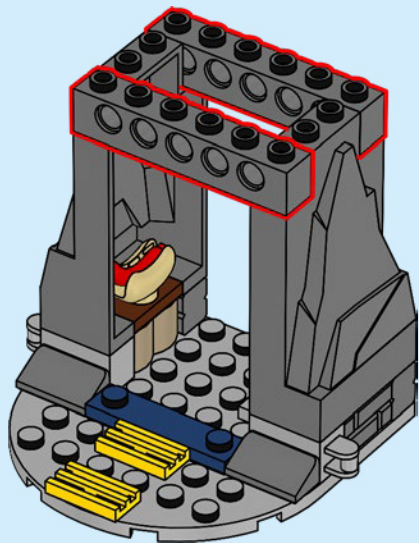

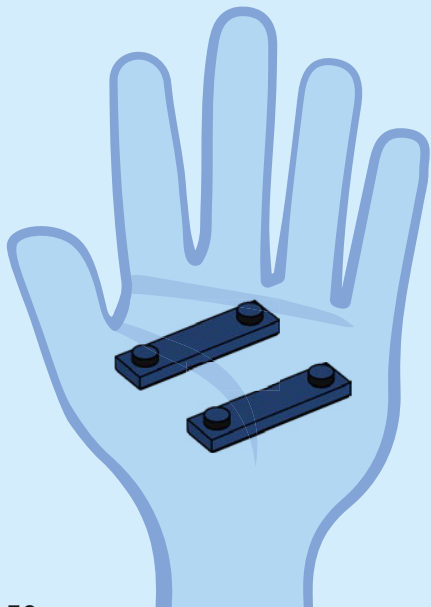

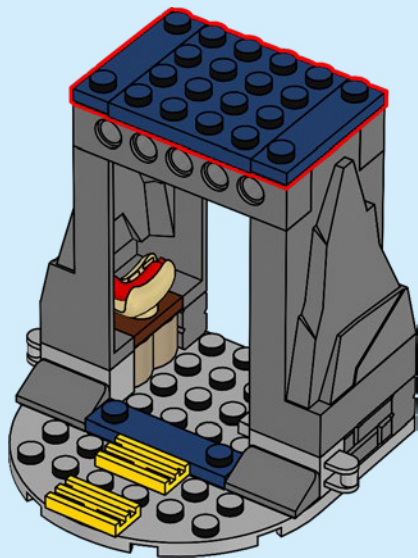

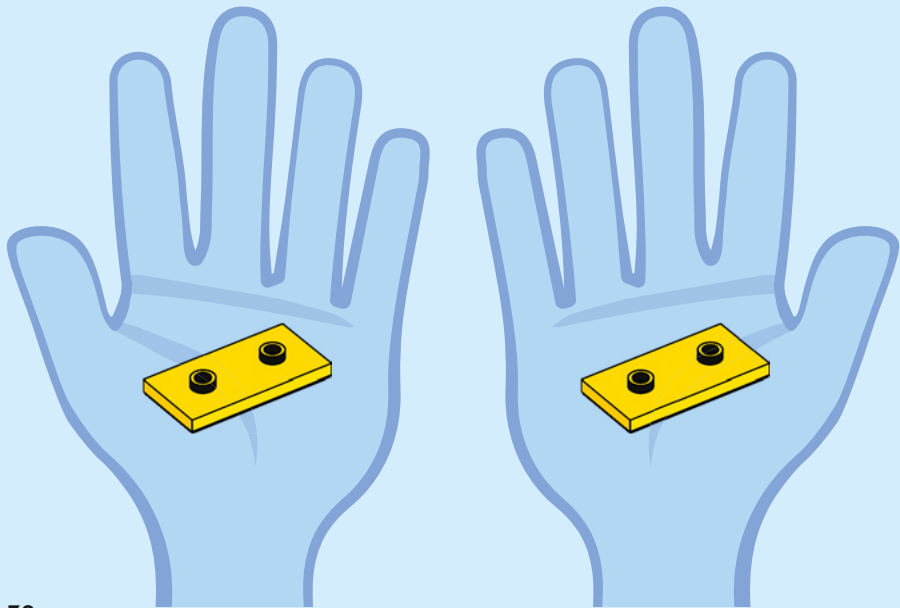

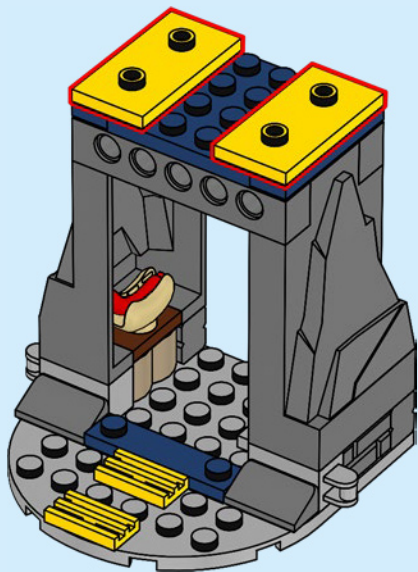

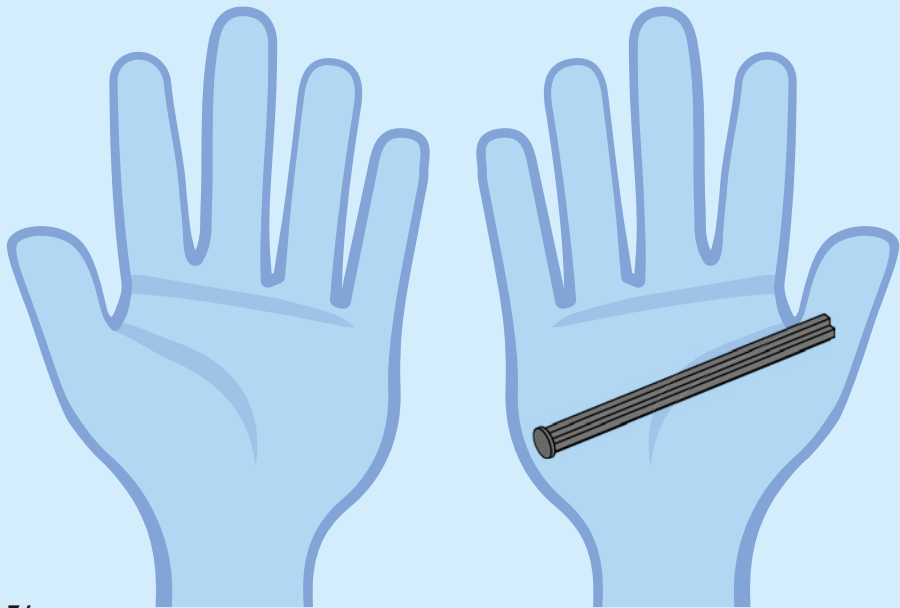

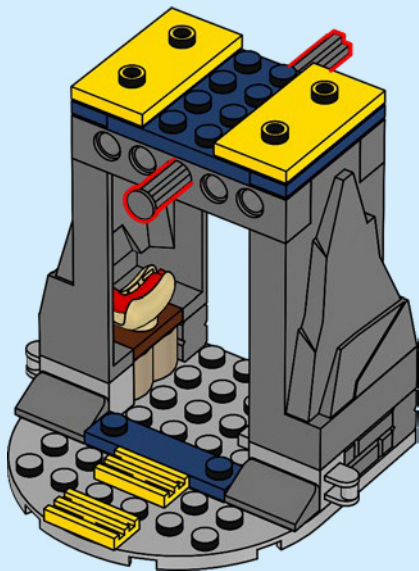

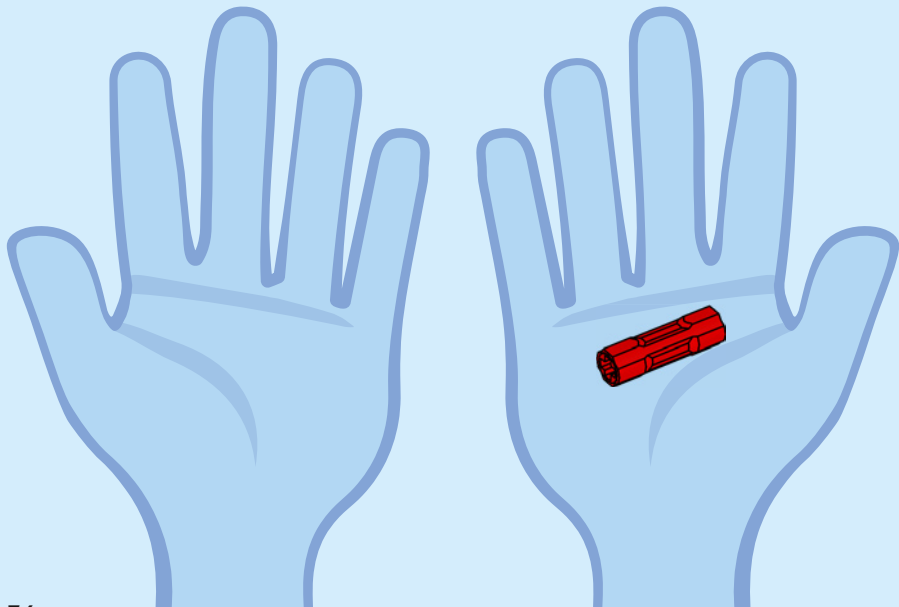



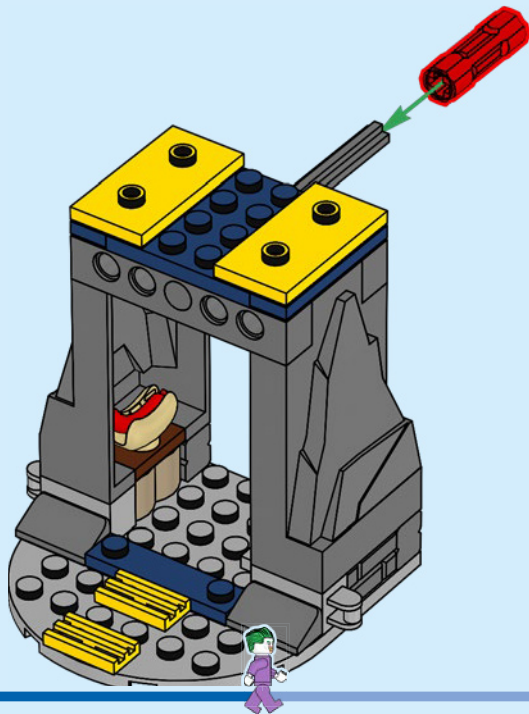

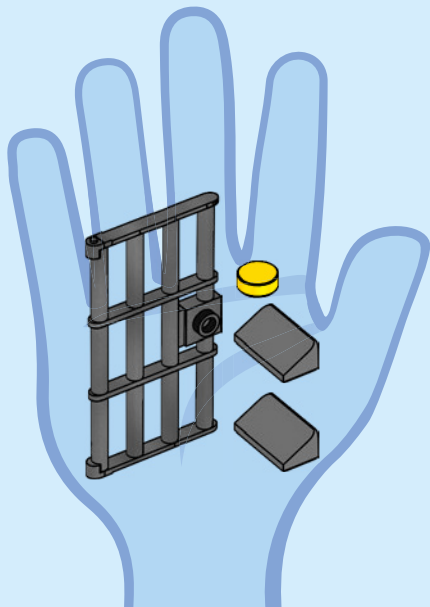
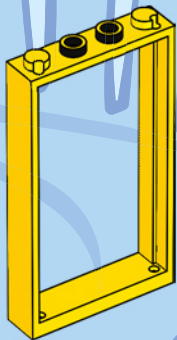

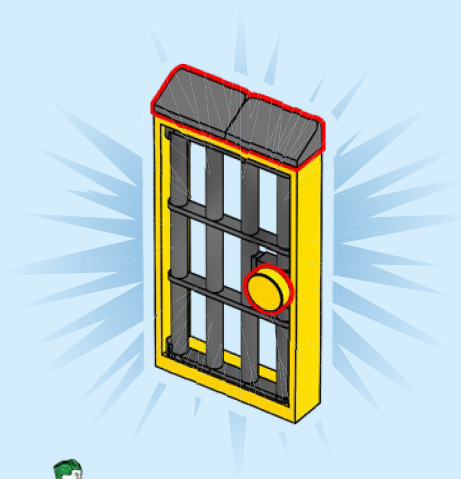
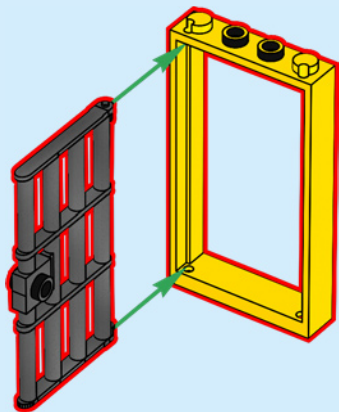

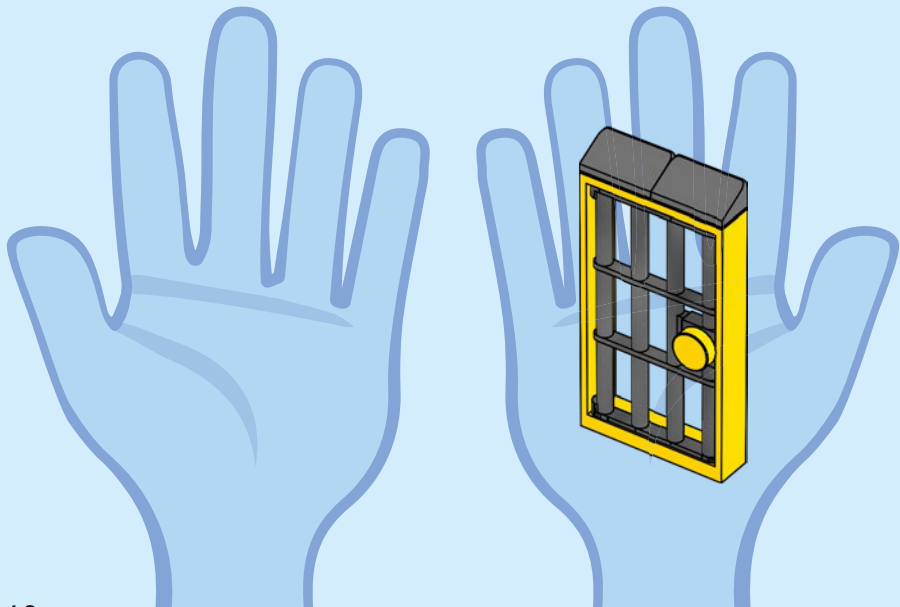

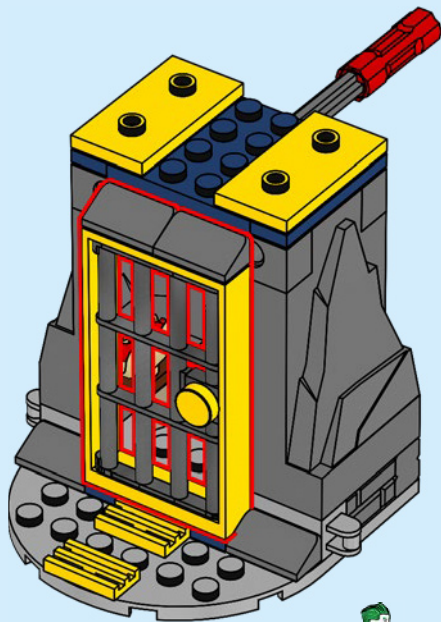

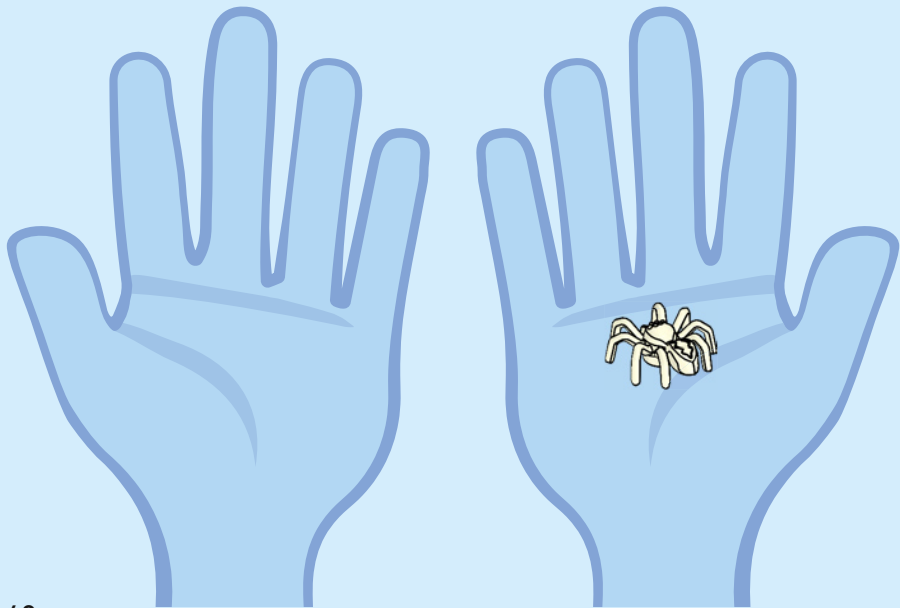

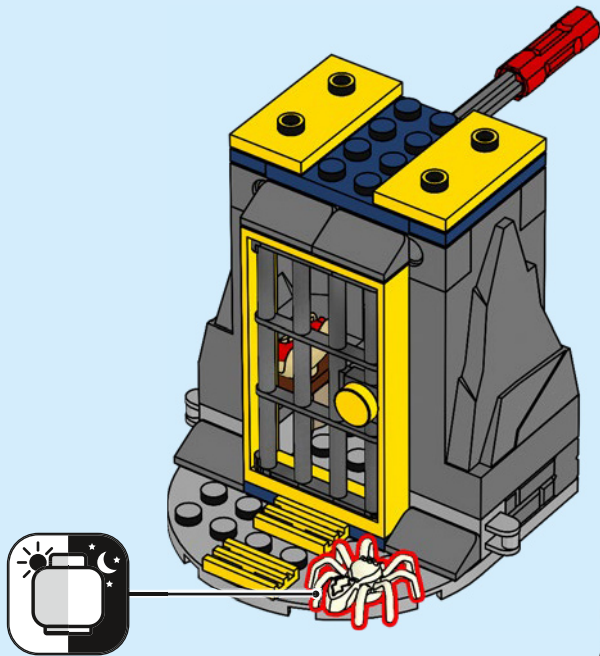

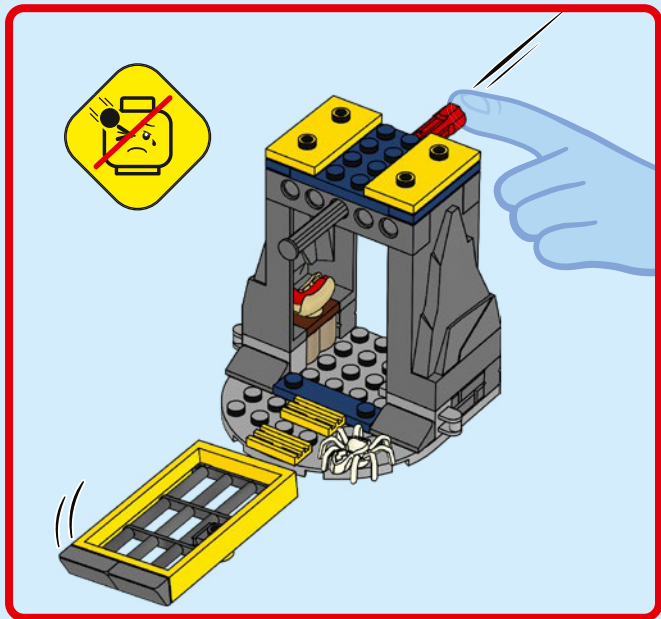



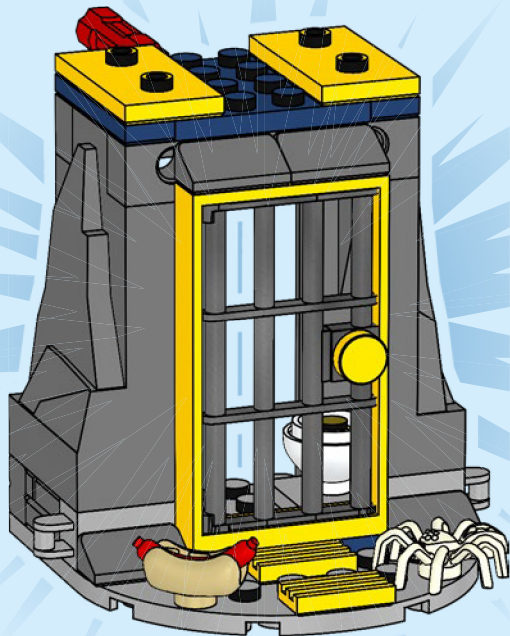



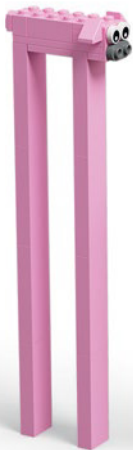

Rebuild  
the  
world™



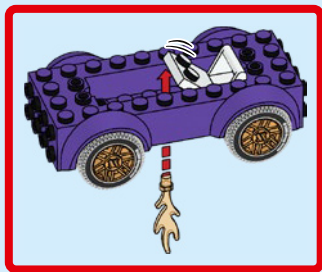

1x  
6448890

1x  
6253694

1x  
6050914

2x  
6281990

1x  
243201

1x  
6047220

2x  
6218822

1x  
300301

1x  
6488958

1x  
6147214

1x  
389921

1x  
6144805

1x  
6273211

1x  
6284577

2x  
302324

3x  
243224

2x  
241224

2x  
4121965

2x  
6337231

1x  
6224666

1x  
6347698

2x  
4260192

2x  
4613151

4x  
371024

1x  
6262947

2x  
300124

2x  
6424448

1x  
663624



  
2x  
6240216

  
1x  
6061678

  
1x  
4520257

  
4x  
6328107

  
1x  
6256612

  
1x  
6273588

  
1x  
6245268

50

  
3x  
6256610

  
3x  
6275133

  
1x  
6221672

  
1x  
6027625

  
2x  
6167741

  
3x  
6092590

  
4x  
4211389

  
1x  
4227657

  
2x  
6198932

  
2x  
4244627

  
3x  
6126082

  
1x  
6492481

  
1x  
6132207

  
1x  
4211404

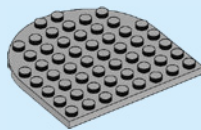
  
1x  
6474254

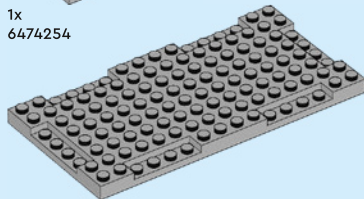
  
1x  
6417816

  
1x  
6489695



1x  
6270008



3x  
4211085



2x  
4210917



1x  
6507862



1x  
6167628



1x  
6475641



1x  
6152814

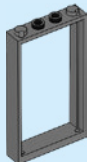

2x  
6262942

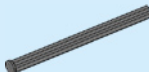

8

1x  
4499858

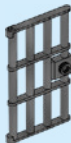

1x  
6037634



1x  
6453182



4x  
4567887



4x  
6268401



4x  
6000311

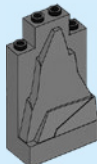

4x  
4513326



1x  
6258524



4x  
4211054



1x  
6302588



2x  
4210725

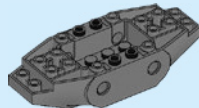

1x  
6439367



[LEGO.com/service](https://www.LEGO.com/service)

YOU COULD  
**WIN**



Scan this QR code or go to  
**LEGO.COM/PRODUCTFEEDBACK** and give us  
your short feedback about this LEGO® set  
for a chance to win a cool LEGO prize.

Terms and Conditions apply\*

**EN: YOU COULD WIN.** Terms and Conditions apply\* **DE: Du könntest GEWINNEN.** Es gelten die Teilnahmebedingungen\* **FR: Tu pourrais GAGNER.** Des conditions s'appliquent\* **IT: Potresti VINCERE tu.** Termini e condizioni sono applicabili\* **ES: Puedes GANAR.** Aplican términos y condiciones\* **PT: Poderá GANHAR.** Aplicam-se termos e condições\* **ZH: 轻松获奖.** 条款和条件适用\* **PL: Szansa na WYGRANĄ.** Obowiązują warunki korzystania\* **CS: Máte šanci VYHRÁT.** Platí všeobecné smluvní podmínky\* **SK: Máte šancu VYHRÁT.** Platia všeobecné zmluvné podmienky\* **HU: TE IS NYERHETSZ.** Felhasználási feltételek érvényesek\* **RO: Ai putea CÂȘTIGA.** Se aplică termenii și condiții\* **BG: Можете да СПЕЧЕЛИТЕ.** Има определени правила и условия\* **LV: Tu vari LAIMĒT.** Ir spēkā noteikumi un nosacījumi.\* **ET: Sul on võimalus VÕITA.** Kehtivad tingimused\* **LT: Jūs galite LAIMĖTI.** Taikomos sąlygos\*

\*[LEGO.com/productfeedback-terms](https://www.lego.com/productfeedback-terms)

LEGO and the LEGO logo are trademarks of the LEGO Group. ©2024 The LEGO Group.  
BATMAN and all related characters and elements © & TM DC (s24)

6522951